



The Signet 2756-2757 Wet-Tap pH and ORP electrodes are general purpose sensors ideal for a wide range of applications where the installation and removal of the electrode can be performed without the need for system shutdown.

The Signet 3719 pH/ORP Wet-Tap Assembly allows installation and removal of pH or ORP electrodes, even under process pressure, without the need for process shutdown during routine electrode maintenance and calibration. Process isolation is achieved during electrode retraction with two sets of double O-ring seals on a unique and compact retraction assembly; no separate valve is required.

The DryLoc connector with corrosion resistant gold plated contacts readily connects the sensor to the mating 2751 pH/ORP Smart Sensor Electronics or the 2760 Preamplifier. The robust polyarylsulphone (PAS) body and choice of bulb pH or flat ORP sensing elements allow a broad range of chemical compatibility for a wide range of applications.

The quick temperature response is available in either a Pt1000 or 3 K Ω temperature sensor and allows compatibility with all Signet pH/ORP instruments.

The Wet-Tap assembly unit can be mounted at any angle and can be used with the Signet DryLoc[®] Wet-Tap pH and ORP electrodes.

Features

- PTFE reference junction resists fouling and chemical attack
- Polyarylsulphone (PAS) body for broad range of chemical compatibility
- General purpose bulb pH glass suitable in a wide range of applications
- Patented DryLoc connector with gold plated contacts
- Pt1000 or 3 K Ω Balco temperature element for quick temperature response
- Electrode removal without process shutdown when installed in the Signet 3719 pH/ORP Wet-Tap Assembly
- Memory chip enabled for access to a wide range of unique features when connected to the Signet 2751 pH/ORP Smart Sensor Electronics
- Special design allows for installation at any angle, even inverted or horizontal





Applications

- Aquatic Animal Life Support Systems
- Recreational Water Monitoring
- Water & Wastewater Treatment
- Effluent Monitoring
- Neutralization Systems
- Sanitization Systems
- Pool and Spa Control

Specifications

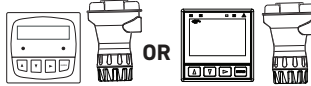
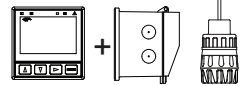
General		
Compatibility	Signet 3719 Wet-Tap Assembly, 2751 Smart Sensor Electronics or 2760 Preamplifier	
Operating Range	pH	0 to 14 pH
	ORP	±1500 mV
Connector	CPVC	DryLoc
Temperature Sensor (pH)	Pt1000 or 3K Balco for pH	
Reference Junctions	Porous PTFE	
	Electrolyte	Saturated KCl
	Elements	Ag/AgCl
Response Time	pH	< 5s for 95% of signal change
	ORP	Application dependent
	Impedance (pH)	< 150 MΩ @ 25 °C
Wetted Materials		
Body	PAS (Polyarylsulphone)	
Reference Junction	Porous PTFE	
Sensing Surface	pH	Glass membrane
	ORP	Platinum
O-rings	FKM	
Connector	CPVC	
Max. Temperature Rating		
Operating Temperature	0 °C to 85 °C	32 °F to 185 °F
Recommended Storage Temperature		
	0 °C to 50 °C	32 °F to 122 °F
The electrode glass will shatter if shipped or stored at temperature below 0 °C (32 °F)		
The performance life of the electrode will shorten if stored at temperatures above 50 °C (122 °F)		
Mounting		
	Any angle is acceptable. Use with 3719 Wet-Tap assembly for mounting electrodes.	
Shipping Weight		
	0.2 kg	0.4 lb
Standards and Approvals		
	Manufactured under ISO 9001 for Quality	

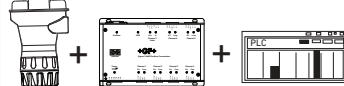
Wet-Tap Installation

System Overview	<p>Panel Mount</p> <p>Signet Instrument 8900 9900 9950 with 2751 Smart Sensor Electronics</p> 	<p>Pipe, Tank, Wall Mount</p> <p>Signet Instruments 9900 with 2751 Smart Sensor Electronics and Rear Enclosure</p> 	<p>4 to 20 mA Input</p> <p>2751 Smart Sensor Electronics and Customer Supplied Chart Recorder, Programmable Logic Controller, or Programmable Automation Controller</p> 	<p>Automation System</p> <p>2751 Smart Sensor Electronics with 0486 Profibus Concentrator and Customer Supplied Programmable Logic Controller or Programmable Automation Controller</p> 
	<p>Signet Model Wet-Tap Electrode 3-2756-WTP, 3-2756-WTP-1 or 3-2757-WTP with 3719 Wet-Tap Assembly</p> 			
	<p>Customer supplied tees and fittings</p> <p style="text-align: right;">All sold separately</p>			

Dimensions

Electrodes 3-2756 Wet-Tap pH,
3-2757 Wet-Tap ORP

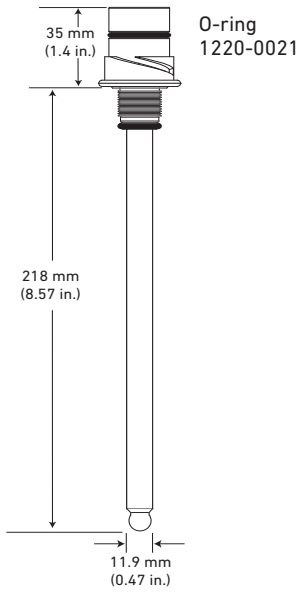

Temperature/Pressure Graph

Note:

The pressure/temperature graphs are specifically for the Signet sensor. During system design the specifications of all components must be considered. In the case of a metal piping system, a plastic sensor will reduce the system specification.

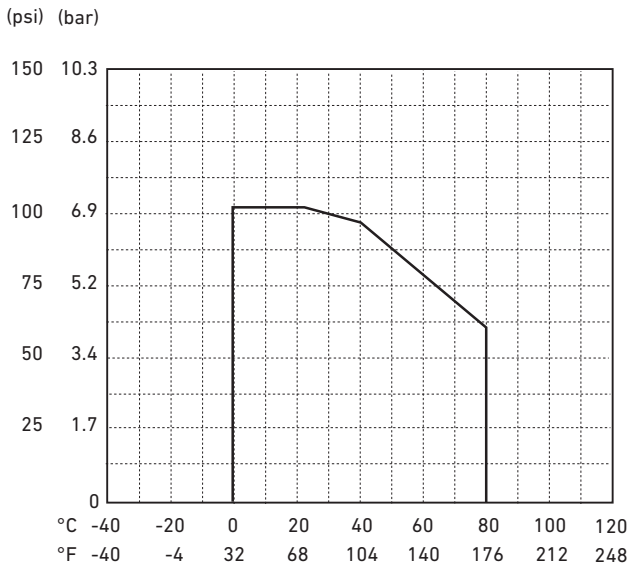

Product Selection Guide

- Step 1 - Choose sensor
- Step 2 - Choose preamplifier or sensor electronics
- Step 3 - Choose Wet-Tap assembly
- Step 4 - Choose a customer supplied mounting option

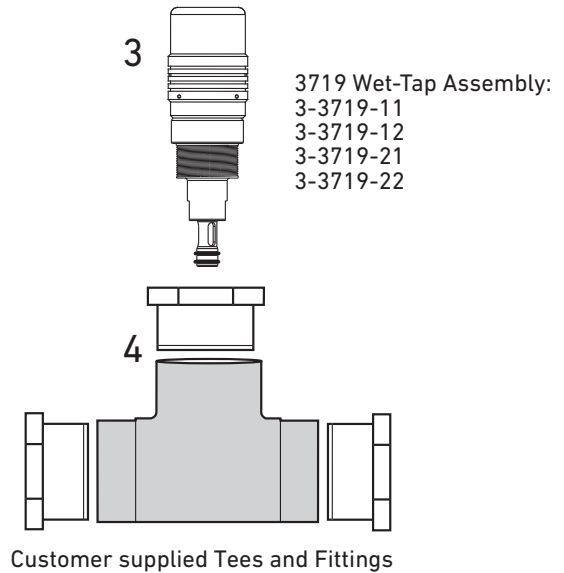
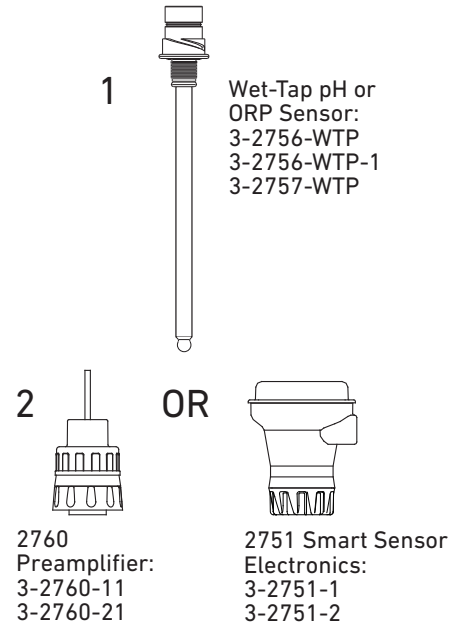

Ordering Information

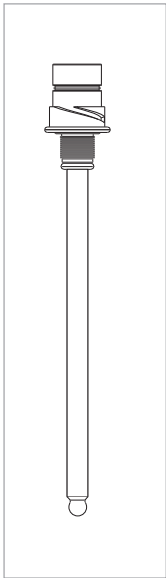

Mfr. Part No.	Code	Tip design	Temperature Element	Use With
DryLoc pH Electrodes				
3-2756-WTP	159 001 390	Bulb	Pt1000	2751 Smart Sensor Electronics*
3-2756-WTP-1	159 001 384	Bulb	3 KΩ Balco	2751 or 2760 Preamplifier**
DryLoc ORP Electrodes				
3-2757-WTP	159 001 391	Flat	N/A	2751 Smart Sensor Electronics* or 2760 Preamplifier**

*The 2751 Smart Sensor Electronics has a digital (S³L) output which is used with the 8900, 9900 or 9950 instruments, and the Profibus Concentrator. It also has a 4 to 20 mA output for connections to PLC's, data recorders, etc.

**The 2760 preamplifier is used for connection directly to older Signet analog transmitters.

Model 2756-2757

Ordering Notes

- 1) pH and ORP electrodes require connection to model 2751-1 or 2751-2 or 2760-X1

Accessories and Replacement Parts

Mfr. Part No.	Code	Description
3-2700.395	159 001 605	Calibration kit: includes 3 polypropylene cups, box used as cup stand, 1 pint pH 4.01, 1 pint pH 7.00
3822-7115	159 001 606	20 gm bottle quinhydrone for ORP calibration (must use pH 4.01 and/or pH 7.00 buffer solutions)
Other		
1220-0114	159 000 854	3719 O-ring, FKM (spare part)
3-0700.390	198 864 403	pH buffer kit (1 each 4, 7, 10 pH buffer in powder form, makes 50 ml of each)
3822-7004	159 001 581	pH 4 buffer solution, 1 pint (473 ml) bottle
3822-7007	159 001 582	pH 7 buffer solution, 1 pint (473 ml) bottle
3822-7010	159 001 583	pH 10 buffer solution, 1 pint (473 ml) bottle
3-2759	159 000 762	pH/ORP system tester kit for all pH instruments
3-2759.391	159 000 764	Adapter cable for use with 2751 and 2760
3800-5000	159 838 107	3.0M KCl storage solution for pH and ORP, 1 pint (473ml) bottle
3-2700.398	159 001 886	O-ring lubricant kit (5 packs of Super Lube, 1cc each)

3-2756WT.099 Rev B (06/19)

© Georg Fischer Signet LLC

3401 Aero Jet Avenue, El Monte, CA 91731-2882 U.S.A. • Tel. (626) 571-2770 • Fax (626) 573-2057 • www.gfsignet.com • e-mail: signet.ps@georgfischer.com
Specifications subject to change without notice. All rights reserved. All corporate names and trademarks stated herein are the property of their respective companies.