

+GF+



Utility

Plan, Build, Operate

Technical Manual
Piping Systems in Utilities

Disclaimer

The technical specifications are not binding. They do not constitute expressly warranted characteristics, nor do they guarantee specific properties or durability. They are subject to modification.

Our General Conditions of Supply apply.

Technical Manual

Piping Systems in Utilities

Technical Manual

Piping Systems in Utilities

	About this manual	
I	Introduction	
II	Application solutions for the utility segment	
III	Plastic piping materials	
IV	Design and laying	
V	System components	

Content

About this manual	9
1 Remarks on use.....	10
2 List of abbreviations.....	11
I Introduction	13
1 GF Piping Systems.....	14
2 Specialized solutions.....	15
3 Quality.....	17
4 Sustainability.....	19
5 Professional development.....	20
II Application solutions	21
1 Water supply.....	22
2 Gas supply.....	24
3 Automation.....	26
III Plastic piping materials	27
1 Properties of plastic piping materials.....	28
2 Approvals and standards.....	36
IV Design and laying	41
1 Basic knowledge.....	43
2 Design.....	49
3 Hydraulic calculation and pressure losses.....	62
4 Laying.....	66
5 Integral jointing technology (welding).....	85
6 Mechanical jointing technology.....	109
V System components	135
1 The ELGEF Plus electrofusion system.....	137
2 Couplers and fittings.....	143
3 Saddles and pressure tapping valves (PTVs).....	146
4 Spigot fittings.....	150
5 Valves for applications in the utility segment.....	151
6 Electrofusion units.....	156
7 Tools and accessories for electrofusion.....	162

Preface

GF Piping Systems is the global expert for plastic piping systems for the safe transportation of water, chemicals and gases. Its systems have proven themselves in more than 100 countries, because they are corrosion-free, light-weight, and quick and easy to install.

Additionally, they serve as a dependable method to reliably supply people all over the world with clean water, to dispose of waste water and to ensure that houses and apartments are heated during the colder months – in short, they ensure everyday quality of life.

This manual gives you an overview of the GF Piping Systems solutions in the utility segment: a comprehensive portfolio of a variety of products – integrated systems consisting of pipes, fittings and valves, as well as jointing technologies and services. The manual will support you in planning and selecting materials, products and jointing solutions for the utility segment and will provide you with information for installation.

GF Piping Systems has been a preferred partner of network operators, planning engineers and installers for more than 60 years. They benefit from our expertise and our competence even in the latest areas, for example in automation and digitalization.

A particular emphasis for us is on supporting the switch from traditional metal to modern plastic systems with all their advantages, where this hasn't yet taken place. At GF Piping Systems, you will find competent partners for all phases of your project. Feel free to contact us at any time.

Plastic piping systems have a working life of at least 50 years. Professional planning, correct selection and installation ensure their reliability, high performance and durability.

Schaffhausen, September 2023

About this manual

Content

1	Remarks on use	10
2	List of abbreviations	11

1 Remarks on use













This manual describes and explains the fundamental aspects of the planning, product selection, processing and laying of pressure pipes for gas and water utilities.

It is suitable as a reference book, a document for professional development and training, or as support for consultations. All specifications are based on the relevant international ISO and EN standards, various national standards, DVS guidelines, and additional information from raw material manufacturers. In addition, the results of extensive internal investigations are incorporated, so the plant engineer, other engineers and installers should find the assistance they require to plan and install a complex piping system properly.

The selection and prioritization of the topics focus on the explanation of design-relevant areas. Detailed product instructions should be taken from the corresponding installation and operating manuals.

Planning aids for industrial and building technology systems are available in separate manuals. For further information, please contact your national representative or refer to www.gfps.com.

Overview of symbols

General symbols used in the document			
	General information		Remarks
	Example		Online calculation tools and mobile applications
Symbols of materials			
	Abrasion resistance		Electrical properties
	Combustion behavior		Mechanical properties
	Chemical resistance		Physiological properties
	Properties		UV and weather resistance
	Application limits		

2 List of abbreviations

Abbreviation	Term
BGA	Bundesgesundheitsamt [German health authority]
BgVV	Bundesinstitut für gesundheitlichen Verbraucherschutz und Veterinärmedizin [Federal institute for consumer protection and veterinary medicine]
BRT	Batch release tests
DIBt	Deutsches Institut für Bautechnik [German institute for construction technology]
DVGW	Deutscher Verein des Gas- und Wasserfaches e.V. [German gas and water association]
DVS	Deutsche Verein für Schweißtechnik [German association for welding technology]
EPD	Environmental Product Declarations
EPDM	Ethylene propylene rubber
FAR	Federal Aviation Regulations
FDA	Food and Drug Administration
FKM	Fluororubber
GRP	Glass-reinforced plastics
ILAC	International Laboratory Accreditation Cooperation
KTW	Plastic drinking water recommendation by the German health authority (BGA in Berlin)
LCA	Life cycle assessment
LPL	Lower Predictable Limit
MCI	Malleable cast iron
MFR	Melt flow rate
MRS	Minimum required strength
NBR	Nitrile rubber
NR	Natural rubber
PB	Polybutene
PE	Polyethylene
PE-X	Crosslinked polyethylene
PP	Polypropylene
PTFE	Polytetrafluorethylene
PVC	Polyvinyl chloride
PVC-C	Post-chlorinated polyvinyl chloride (increased chlorine content)
PVC-U	Polyvinyl chloride, plasticizer-free
PVDF	Polyvinylidene fluoride
PVT	Process verification tests
SAS	Swiss Accreditation Office
SDR	Standard dimension ratio
TEPPFA	The European Plastic Pipes and Fittings Association
TT	Type Testing
UP-GF	Unsaturated polyester resin, glass-reinforced



Introduction

Content

1	GF Piping Systems	14
2	Specialized solutions	15
3	Quality	17
3.1	Quality assurance at all levels	17
3.2	Management systems	17
3.3	Accredited test center	17
4	Sustainability	19
4.1	Environment.....	19
4.2	Social aspects	19
5	Professional development	20

1 GF Piping Systems

Worldwide presence

Our worldwide presence ensures customer proximity. Sales companies in over 30 countries and representatives in another 80 countries provide customer service around the clock. With 50 production sites in Europe, Asia and the USA, we are close to our customers and meet local demands, while a modern logistics concept with local distribution centers ensures that our products are available quickly at all times. Our customers can rely on specialists from GF Piping Systems worldwide.

Complete solutions provider

With over 60,000 products, we offer individual and comprehensive system solutions for a multitude of industrial applications. With a view to ensuring the profitability of individual projects, we optimize processes and applications that are integrated into overall systems and thus continually set new standards in the market. The technological advantages we achieve through this are passed on to our customers directly. With a global network of competent contact persons, our customers also benefit personally from our over 50 years of experience in the plastics industry. From planning to project completion, we support our customers as a strong and reliable partner, actively contributing to the know-how of an industrial company that has been successful in the market for 200 years.

- GF Corporation worldwide**
- + Sales company
 - + Production site
 - + Agents
 - + Logistics center
 - + Suppliers

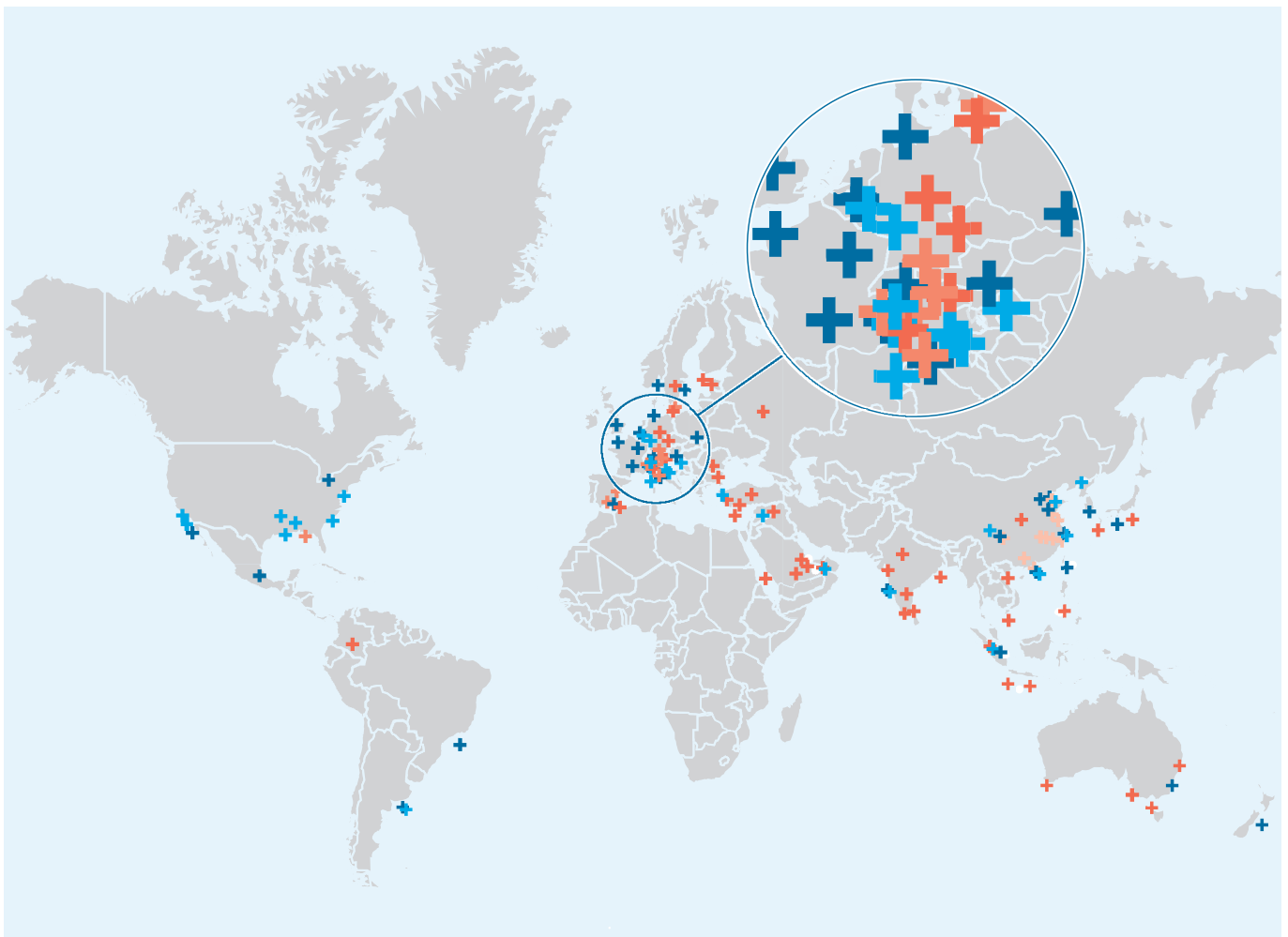

2 Specialized solutions

GF Piping Systems uses specialized solutions to support the light-weight design and installation of state-of-the-art plastic piping systems so that owners and planning engineers can concentrate on their daily work without interruption. From support with the planning of new projects to inspecting the condition of old systems, GF Piping Systems helps with all stages – fully equipped with our complete range of solutions.



Engineering

Increase the efficiency of your project with the tailor-made analysis packages from GF Piping Systems and decide which offer is right for you according to your needs. You have the choice between Project Analysis and Advanced Engineering, thus always receiving the appropriate support in every phase of your project. Established knowledge, guiding you through.



Customer-specific Product Design and Prefabrication

Having your individual needs and application in focus, our customizing teams forge the solution that fits you best, developing custom-made parts to complete systems or special solutions produced in small series, individual consulting and off-site prefabrication. Through our global network of flexible locations, we offer a wide range of comprehensive solutions. Tailored innovation, inspired by you.



CONNECT Conrivo

CONNECT Conrivo is a cloud-based field data collector for piping systems, supporting you with a wide range of online functionality and information. GF Piping Systems helps you streamline your decision-making processes and provide your team with product and process data, registering the precise position of all your components and monitoring the installation progress and quality in real time. Field data collection, keeping you on track.



Condition Analysis

Integrity of a piping system is essential for owner/operators of water, gas and chemical process plants. GF Piping Systems specialists inspect samples in our state of the art accredited materials testing laboratory offering a 'Fit for Service' certification via microscopic analysis, visual inspections and practical testing. This attention to detail enables informed decisions throughout a project's operation. Performance assured, for your peace of mind.



ProSite

ProSite from GF Piping Systems is the logistics solution that reduces the administration effort of ordering, reordering, and accounting of piping system components. It simplifies the stock management of installation projects, reducing necessary workforce and related costs, supporting your team and project design process from the outset to ensure that a sustainable and efficient solution is achieved. Material flow, ready when you are.



Training

GF Piping Systems instructional courses to help you teach your customers and their installers essential knowledge for the welding of pipes and piping components, as well as in-depth knowledge of butt and electrofusion connections. With Specialized education from GF Piping Systems, we help prevent damage before it occurs, with well-trained and qualified installers. Trusted training, empowering you.



Digital Libraries

The libraries cover three key areas for the design, creation and maintenance of a project: Building Information Modeling, the Plant Design Software and the CAD Library, helping you reduce costs and construction times. Unlimited collaboration, unleash your creativity.



Design Assistance

Our Design Assistance includes providing technical manuals on a multitude of topics and an extensive CAD library. From detailed information on products, systems and materials to practical online calculation tools and personal assistance, we back you with our expertise. Valuable insight, the tools you need.



Technical Hotline

Our customer support comprises an international team of experts, which works closely with local sales companies. This pool of highly trained individuals is available to resolve any questions or problems that may arise as your project comes to life. Superior help, when you need it



Rental pool

In many countries, GF Piping Systems provides machines and tools to rent for various jointing technology applications such as butt welding, electrofusion and mechanical jointing.

3 Quality

3.1 Quality assurance at all levels

Quality creates safety and is the basis for trust. In customer relationships, project work, development, production and the specific application of products, quality awareness and standards are the decisive factors for sustained success. The fundamental importance of quality determines our actions, shapes our understanding of quality, and is reflected in our own demand for quality.

The systematic integration of partners and suppliers is part of our comprehensive understanding of quality and guarantees the binding assurance of the quality standard along the entire value chain.

GF Piping Systems is bound to the high quality standards of its customers and considers itself actively responsible for meeting customer requirements as well as upholding legal standards. The rigorous implementation of our quality policy represents an obligation for every single person. Consequently, the focus on quality in service provision is a matter of course for all employees working in the company.

3.2 Management systems

Quality, the environment, safety at work and health protection have always played a very important role in the Georg Fischer Group. For this reason, all production companies as well as many sales companies of GF Piping Systems are certified in accordance with the ISO 9001 quality management system. Furthermore, all of our production sites are certified in accordance with ISO 14001. The standard defines criteria that are applicable worldwide for efficient environmental management systems and, as a result, is considered to be the basis for optimizing environmentally relevant processes.

As part of our sustainability activities, all production sites have also been certified in accordance with OHSAS 18001, the international standard in the area of occupational health and safety. Newly acquired or newly founded production companies are required to establish a quality, environmental and occupational safety management regime within a period of three years.

3.3 Accredited test center

The test laboratory of GF Piping Systems is a test center accredited in accordance with ISO/IEC 17025 for components of piping systems. It inspects all types of pipes, pipe connections, connecting elements, fittings, manual and actuated valves, and flow meters according to relevant standards and external as well as internal specifications.

Customers of the test laboratory are the R&D departments, manufacturing plants, end users of GF Piping Systems' components and other external customers.

Activities include development and product release tests for R&D departments (TT, type testing), batch release tests (BRT) for our own plants, process verification tests (PVT) and tests for external customers.

The continuous training and specific expertise of our employees, the technical state of our testing equipment, and properly documented test sequences are basic prerequisites for the accreditation of the test laboratory in accordance with ISO/IEC 17025. The accreditation by SAS (Swiss Accreditation Office) is confirmed through a certificate. Auditing takes place annually and the accreditation is renewed every five years.



The issuer, SAS, is a member of the International Laboratory Accreditation Cooperation (ILAC). All test centers accredited by members of the ILAC are obliged to formally recognize any test report issued by a fellow member. This permits us and our customers in turn to use the test reports of accredited analyses originating from our test laboratory for product approvals and quality certificates, etc., for which specific test reports still need to be submitted. Thus, time and costs are often reduced considerably.



The accredited testing includes:

- Long-term internal pressure testing (EN ISO 1167, EN ISO 10931, EN ISO 15493, EN ISO 15494, ISO 9393)
- Burst tests on molded parts and pipes
- Crush test (ISO 9853)
- Impact resistance test (ISO 13975)
- Decohesion test (ISO 13955, ISO 13956)
- Peeling test (ISO 13954)
- Determination of the tensile strength of test specimens with butt fusion joints (ISO 13953)
- Pressure drop test (EN 12117)
- Determination of density (EN ISO 1183)
- Melt flow rate MFR (EN ISO 1133)
- Determination of the oxidation induction time OIT (EN ISO 11357-6)

The full scope of the accredited tests is listed in an area of application. This area of application, which is constantly being updated, can be viewed online: www.sas.ch ► Accredited sites ► Search ► STS 094.



4 Sustainability

- As an internationally operating industrial group, GF forms a part of society and is therefore keen to harmonize economic, ecological and social aspects. According to this responsibility, our industrial topics and societal activities are oriented towards long-term sustainable goals. It is our endeavor to embed sustainability in all our distribution companies. Our sustainability targets, whose attainment we communicate regularly and transparently, drive our actions.

4.1 Environment

For GF Piping Systems, our own environmental responsibility is an integral aspect of all our business activities. Because we regard environmental awareness as one of the most important values of our company, all internal structures and processes are oriented toward sustainability. We strive to save natural resources and work relentlessly on optimizing the eco-friendliness of our products and their applications. Outstanding material characteristics and innovative technologies form the basis of our environmentally friendly and energy-saving solutions. By supplying our customers with complete piping systems, we support and promote ecological and cost-efficient operating processes in many industries and in day-to-day life. To obtain detailed information about the environmental compatibility of our products, we monitor all phases of the product life cycle in detail, which also allows us ultimately to improve the carbon footprint of our products.

4.2 Social aspects

Attractive workplaces, interesting tasks, goal-oriented training and professional development, as well as fair wages and good social benefits contribute to securing the future of the company. GF Piping Systems operates with this responsibility as its premise. With locations in over 30 countries, GF Piping Systems views the multitude of cultures, religions, nationalities, genders and age groups as a valuable source for talent, creativity and expertise. This makes the extraordinary achievements possible, carried out by over 7,600 employees of GF Piping Systems worldwide.

i Additional information about sustainability can be found at www.gfps.com/gfps-nachhaltigkeit

5 Professional development

Qualified employees are one of the key factors for the success of a company. Only highly motivated and well-trained employees with the appropriate know-how and a strong customer focus are reliable partners.

GF Piping Systems, as a professional system and solution provider, offers courses and training with a focus on product knowledge, application know-how, the correct sales arguments and different customer requirements.



Joining, measurement and control technology are becoming increasingly innovative. To stay up to date, one thing is essential: professional development. GF Piping Systems makes a significant contribution in this regard. No matter what your field of expertise may be – utilities, building technology or industrial applications – all specialists can benefit from the training and courses, which are adapted to individual market segments and applications.



We offer a customized program for sales personnel and professional groups such as installers, planning engineers and plant constructors. Besides the theory, we attach great importance to hands-on practice. Our rooms are especially equipped for practical training and can accommodate up to 100 people training simultaneously under ideal conditions that simulate reality.



We work closely with our sales personnel when selecting trainers. There are basic, advanced and master courses, and content is aligned across all of them.



For additional information about the current training program, visit www.gfps.com.

Application solutions in the utility segment

Content

1	Water supply	22
1.1	Overview.....	22
1.2	Leading systems.....	23
2	Gas supply	24
2.1	Overview.....	24
2.2	Leading systems.....	25
3	Automation	26
3.1	Overview.....	26
3.2	Measurement.....	26
3.3	Control technology.....	26

1 Water supply

1.1 Overview

Providing hygienically impeccable drinking water that is pure in taste, odor, and appearance is crucial for maintaining good health. The global demand for a secure supply of clean drinking water is on the rise. In response to the diverse needs of the water supply sector, GF Piping Systems offers a comprehensive array of cutting-edge technologies and specialized products that are specifically designed to cater to the water supply industry. With their exceptional expertise and leading-edge knowledge in all aspects of water applications, GF Piping Systems excels in finding the perfect solutions.

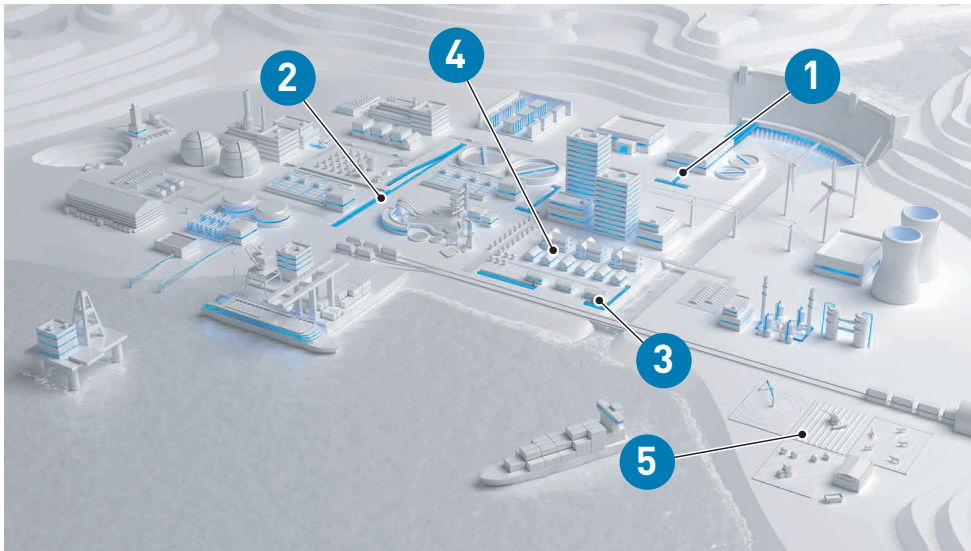

1 Water distribution lines

For water distribution in residential areas, safe and reliable connections are a key factor for success. However, this task can often present considerable challenges. GF Piping Systems understands the need for proper tools, high-performance jointing technologies and connecting parts, and expert support on site.

2 Water supply lines

For a reliable, economical and sustainable water supply, it is essential that all piping components, such as pipes, fittings and valves, are safely and reliably connected. GF Piping Systems offers an extensive assortment of jointing technologies. The electrofusion system ELGEF Plus ensures a homogeneous material connection between pipe and fitting that contributes to a reliable water network. With the MULTI/JOINT system, all kinds of materials can be connected in a quick, safe and simple way.

3 Water service lines and house connection lines

In the final stage of the water network, water service lines bring water to the meter. Due to its flexibility, homogeneous material jointing technologies and many other positive characteristics, PE is now the most popular material for new installations. Thanks to the modular electrofusion system ELGEF Plus, a suitable solution can be found for every application. ELGEF plus components like fittings and saddles are made to match, and when put together they form reliable, leak-proof connections. With just a few products, a wide range of different combinations can be realized. PE valves also play a significant role in establishing a reliable and secure network as part of the ELGEF Plus system.





4 Pressure sewage lines

Instead of relying on gravity, pressure sewage systems utilize pumps to transport waste water to the treatment plants. Pressure sewage systems generally use pipes with smaller diameters that are more cost-effective and easier to install. Opting for the PE system from GF Piping Systems in such cases makes it possible to realize a reliable network with an operating life of 100 years.

5 Irrigation

A growing global population and climate change are leading to ever greater food and water scarcity. Food production is becoming less and less dependent on local weather conditions with the construction of large greenhouses and extensive irrigation systems to increase the output of food per square meter. Easy-to-install systems and ensuring the supply of water throughout the product lifecycle are becoming increasingly important. GF Piping Systems provides an extensive range of products for irrigation as well as on-site training and fast deliveries.

1.2 Leading systems

ELGEF Plus	MULTI/JOINT®	iJOINT	Machines	Tools
				
d160 – d2000 mm, PN10 d20 – d1200 mm, PN16	DN50 – DN1025 mm	d16 – d110 mm	Butt fusion d40 mm – d1600 mm	d20 – d2000 mm
Electrofusion fittings, spigot fittings, seamless bends, segmented fittings and pipes	Multi-area couplings, reduction couplings, (reduced) flange adaptors, curves, end caps, PE adaptors, foot bends	Couplings, tees, bends, reducing pieces and saddles, transition fittings, universal fittings	CNC-technology up to d630 mm Electrofusion MSA 125, 230, 330, 340 (transformer) MSA 2.0, 2.1, 4.0, 4.1, 2.0 MULTI (inverter technology)	Rotary peelers, clamping devices, top-load tools, cutting tools, re-rounding tools, squeeze-off tools, tapping devices

2 Gas supply

2.1 Overview

For decades, gas has been delivered through a network of buried transmission and distribution pipes to homes and industries. It has become an important form of energy.

During recent years, the gas supply industry has made substantial investments to enhance quality and ensure consistency in the operation and maintenance of gas supply networks. GF Piping Systems provides high-quality systems and services for the building and maintenance of these networks, thus contributing to safe and reliable gas transportation.

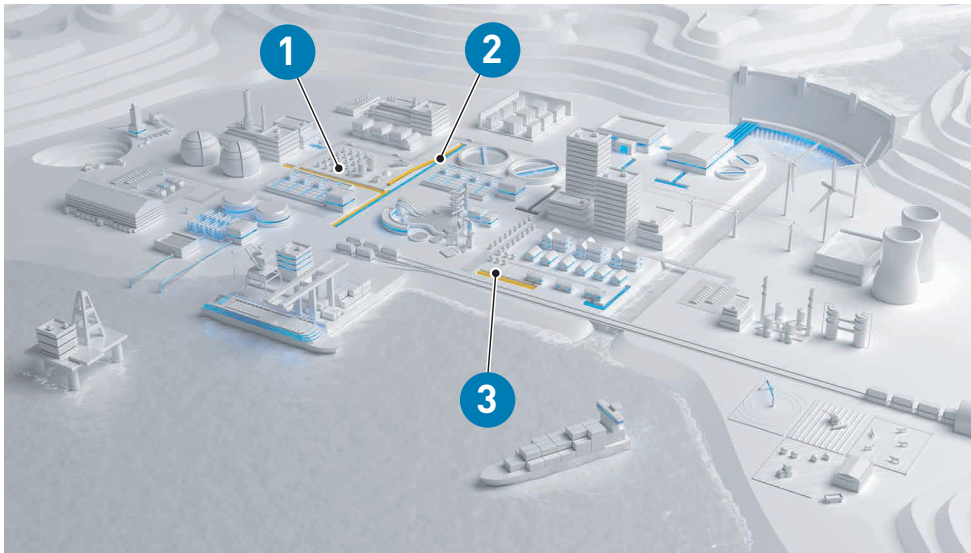

1 Gas transportation lines

When transporting gas in residential areas, safe and reliable connections are a key factor for success. However, this task can often present considerable challenges. GF Piping Systems understands the need for proper tools, high-performance jointing technologies and connecting parts, as well as expert support on site.





2 Gas supply lines

For a reliable, economical and sustainable gas supply, it is essential that all piping components, such as pipes, fittings and valves, be safely and reliably connected. GF Piping Systems offers an extensive assortment of jointing technologies. The electrofusion system ELGEF Plus ensures a homogeneous material connection between pipe and fitting that contributes to a reliable gas network. With the MULTI/JOINT system, all kinds of materials can be connected in a quick, safe and simple way.

3 Gas service lines and house connection lines

In the final stage of the gas grid, house connections bring gas to the meter. Due to its flexibility, homogeneous material jointing technologies and many other positive characteristics, PE is now the most popular material for new installations. Thanks to the modular electrofusion system ELGEF Plus, a suitable solution can be found for every application. ELGEF plus components like fittings and saddles are made to match, and when put together they form reliable, leak-proof connections. With just a few products, a wide range of different combinations can be realized. PE valves also play a significant role in establishing a reliable and secure network as part of the ELGEF Plus system.

2.2 Leading systems

ELGEF Plus	Valves	MULTI/JOINT®	Machines	Tools
				
d160 – d2000 mm, PN10 d20 – d1200 mm, PN16	PE ball valves up to d225 mm	DN50 – DN600 mm	Butt fusion d40 – d1600 mm	d20 – d2000 mm
Electrofusion fittings, spigot fittings, seamless bends, segmented fittings and pipes H2 ready (DBI)	Pressure tapping valves with outlet up to d63 mm, main pipe dimension up to d400 mm	Multi-area couplings, reduction couplings, (reduced) flange adaptors, curves, end caps, E-adaptors, foot bends H2 ready (DBI)	CNC-technology up to d630 mm Electrofusion MSA 125, 230, 330, 340 (transformer) MSA 2.0, 2.1, 4.0, 4.1, 2.0 MULTI (inverter technology)	Rotary peelers, clamping devices, top-load tools, cutting tools, re-rounding tools, squeeze-off tools, tapping devices

3 Automation

3.1 Overview

PE piping systems are not just used in the gas and water supply industries, but increasingly also in industrial applications.

Whether for measurement, control or propulsion, our technologies are not only fully compatible with one another, but – regardless of their dimensions – can also be seamlessly integrated into your piping systems using suitable system components from GF Piping Systems.

3.2 Measurement

Product categories

- Flow measurement
(ultrasonic, paddlewheel, electromagnetic, turbine, float)
- pH/ORP
- Conductivity/resistivity
- Pressure/fill level
- Temperature
- Clouding
- Chlorine/chlorine dioxide
- Dissolved oxygen



3.3 Control technology

Precise control technology

An intelligent design makes life easier. All our sensors can be connected to the same transmitter. Our 9900 single-channel, multi-parameter controller ensures the secure and efficient operation of your entire control circuit. Thanks to its modular design, additional functions such as batch control or communication technologies can be added at any time without any problems. The parameters of the currently connected sensors are displayed at a glance on the large, well-lit display.

Reliable actuator technology for fittings

The modular design of our actuator range allows you the utmost flexibility for configuration. Valves and actuators can be combined flexibly, and additional functions such as position control or monitoring systems can be added as options. Depending on your requirements, you can choose between electric, magnetic or pneumatic actuators. Made entirely from plastic, our entire actuator range is designed for the toughest environmental conditions and is resistant to aggressive chemicals and seawater.

- Easy to install: Clamp-on flow meters can be attached directly to the outside of the pipe while the system is running.
- Easy to operate: An intuitive menu structure and the clear parameter indicator are integral components of our user-friendly control technology.
- Easy to combine and retrofit: The fast and easy configuration is a key advantage that demonstrates the boundless flexibility of our automation solutions..



Plastic piping materials

Content

1	Properties of plastic piping materials	28
1.1	Polyethylene (PE)	28
1.2	Advantages of polyethylene pipe systems	30
1.3	Sustainability	35
2	Approvals and standards	36
2.1	Approvals of products	36
2.2	Standards and guidelines	37



1 Properties of plastic piping materials

1.1 Polyethylene (PE)

PE properties (reference values)

Property	PE 80 value ¹	PE 100	Unit	Test standard
Density	0.93	0.95	g/cm ³	EN ISO 1183-1
Yield stress at 23 °C	18	25	N/mm ²	EN ISO 527-1
Tensile e-modulus at 23 °C	700	900	N/mm ²	EN ISO 527-1
Charpy notched impact strength at 23 °C	110	83	kJ/m ²	EN ISO 179-1/1eA
Charpy notched impact strength at -40 °C	7	13	kJ/m ²	EN ISO 179-1/1eA
Crystallite melting point	131	130	°C	DIN 51007
Thermal conductivity at 23 °C	0.43	0.38	W/m K	EN 12664
Water absorption at 23 °C	0.01 – 0.04	0.01 – 0.04	%	EN ISO 62
Color	9005	9005	RAL	–
Oxygen index (LOI)	17.4	17.4	%	ISO 4589-1



¹ Typical characteristics measured on the material should not be used for calculations.

General

All polymers that consist of hydrocarbons of the formula C_nH_{2n} with a double bond (ethylene, propylene, butene-1, isobutene) are collectively referred to as polyolefins. This group also includes polyethylene (PE), which is a semi-crystalline thermoplastic. Polyethylene is perhaps the best known plastic and has the following chemical formula: $-(CH_2-CH_2)_n$. Polyethylene is a hydrocarbon product that is compatible with the environment. Both PE and PP are among the homopolar materials, so PE does not dissolve in common solvents and hardly swells. This means that PE pipes cannot be connected to fittings with adhesive. The appropriate jointing method for this material is fusion.

Grades of high molecular weight and with medium to high density have become established for industrial piping system construction. The grades are classified in accordance with their long-term creep strength in PE 80 (MRS 8 MPa) and PE 100 (MRS 10 MPa). In this context, we also talk about third-generation PE grades, while PE 80 grades, in most cases, belong to the second generation. PE grades of the first generation – PE 63 according to current classifications – are now barely represented in the market. The long-term creep rupture strength is tested according to ISO 1167 and calculated in compliance with ISO 9080. In piping system construction, PE is mostly used for installation of buried gas and water pipes. For this application area, polyethylene has become the dominant material in numerous countries, but building technology and industrial piping system construction also utilize the advantages of this material.

Alternative, trenchless installation methods, such as relining, trench cutting, and flush drilling, require new materials: PE 100-RC (raised crack resistance) made from modified PE 100 has a greater resistance to slow crack growth and stress cracks. The advantage of PE 100-RC as a material is that notches and furrows in the pipe have less of an impact on its working life in the long term, which is why this material is often used for trenchless laying.

Advantages of PE and PE piping systems

- Lightweight
- Excellent flexibility during storage and laying as well as resistance to movements in the earth
- Good abrasion resistance
- Corrosion resistance, no additional measures required
- High impact strength even at low temperatures
- Good chemical resistance
- Smooth pipe surface resulting in higher flow rate, less encrustation and lower energy costs
- Suitable for trenchless installation techniques

UV and weather resistance

Because of the black pigments used, black polyethylene is very weather-resistant. Even longer exposure to direct sunlight, wind, and rain has a very limited effect on the material characterization in operation.



Chemical resistance

Polyethylene shows good resistance against a broad range of media. Studies by independent institutes have shown that the expected working life of PE pipes, even under extreme conditions, exceeds the lifetime required by standards. Detailed information can be found in the extensive list of chemical resistance from GF Piping Systems, or you can contact the responsible GF Piping Systems office directly.



Abrasion resistance

PE shows excellent resistance to abrasive stress. Depending on the size, geometry, and velocity of the solids being transported, PE has major advantages, in particular over metallic materials. PE piping systems are thus used in many applications for transporting media that contain solids.



Application limits

The application limits of the material, on the one hand, depend on embrittlement and softening temperatures, and on the other, on the nature and the duration of the application. The corresponding thrust-temperature diagrams offer specific information regarding this matter.



Combustion behavior

Polyethylene is one of the flammable plastics, with an oxygen index of 17%. A plastic material is considered to be flammable with an oxygen index below 21%. PE drips and continues to burn without soot after removal of the flame. Basically all burning processes release toxic substances, particularly carbon monoxide. Burning PE produces primarily carbon dioxide, carbon monoxide, and water.



Electrical properties

Like most thermoplastics, polyethylene is non-conductive. This means that no electrochemical corrosion takes place in PE systems, although the non-conductive properties have to be taken into account because an electrostatic charge can build up in the pipe. Polyethylene provides good electrical insulation properties. The specific volume resistance is 3.5×10^{16} Ωcm and the specific surface resistance is 10^{13} Ω . These figures have to be taken into account wherever there is an ignition hazard or risk of explosion.



Physiological properties

The black polyethylene materials from GF Piping Systems are authorized for use in food applications. The fittings are odorless, tasteless, and physiologically harmless, making them suitable for use in all related areas. For details of existing approvals for applications with drinking water or food, please contact the responsible GF Piping Systems office.



1.2 Advantages of polyethylene pipe systems

For gas and water utility companies, investing in pressure piping system networks involves considerable financial capital. (For the European water supply, on average approx. 80 % of the total investment goes into the pipes and only 20 % into plants!) In addition to the user requirements (e.g. safety, gas/drinking water quality, security of supply, sustainability), the chosen piping system also needs to satisfy the economic demands of the utility company. It's not the pure acquisition costs for the piping components which are the main issue here, but the total cost of ownership for planning, building, operating, and maintenance.

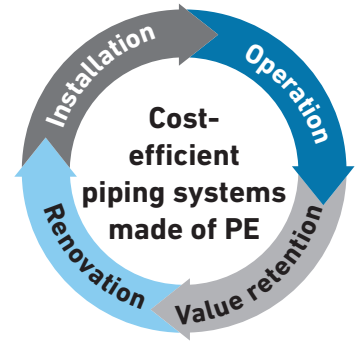

Increase in PE pipes

Polyethylene piping systems have shown enormous growth rates worldwide over recent decades, as they surpass the performance of traditional piping materials.

The main reasons why decision-makers in the gas and water utilities industry use buried pressure pipelines made of polyethylene are:

- The reliability of the system and the jointing technology, and the demonstrably low rate of damage of all materials.
- The demonstrable durability with a service life of >100 years.
- The demonstrably lowest use of resources and the smallest carbon footprint.
- The most economical solution in the total cost of ownership.
- No corrosion
- Major flexibility of the material and the jointing technology
- Lightweight

1.2.1 Working life >100 years

Modern polyethylene piping materials (PE 100 with far more favorable creep rupture behavior and improved heat stabilization) that have been appropriately processed are likely to have a calculable working life of over 100 years.

Investigations of disassembled old PE piping systems by the company Hoechst have shown that after an operating life of >40 years, these PE pipes exhibit a significant further remaining life of another 27 years. The forecast 50-year minimum life of the PE material generation of that time has therefore been significantly exceeded.

Further investigations have been carried out by Teppfa and the significant content summarized in a policy document, which substantiates the abovementioned minimum life of 100 years based on worldwide studies. The policy document can be found at www.teppfa.eu in the "Media&Download" area.

1.2.2 Lowest damage rate

The damage statistics play a crucial role in the assessment of operation and maintenance. The maintenance costs can only be kept low if the damage rates are low.

In the damage statistics of the European water supply associations (e.g. DVGW), PE pipelines have for years exhibited the lowest rates of damage. The lower damage frequency of PE piping systems means a higher security of supply but also lower expenditure and costs for maintenance and repair of the piping network.

The minimal damage frequency makes it clear that polyethylene provides more reliable and more durable piping systems than using metal materials that are resistant to bending.

reliable	
durable	
sustainable	
cost-efficient	



Source: Technical report 3R – Hessel, Schulte 09-2006

1.2.3 Reliable under pressure

The flexibility and load capacity of pipelines under external mechanical loads represents an important criterion, especially in areas of seismic activity such as earth settlement and movement.

In Japan, after the earthquake and tsunami disasters of recent years, the pipeline materials used and their susceptibility to damage were investigated in the three affected cities of Tome, Kurihara, and Osaki. The flexibility and crack resistance of polyethylene exhibited many times lower instances of damage than traditional pipe materials made of metal, and the use of PE as a piping system material has risen dramatically in Japan since these events.

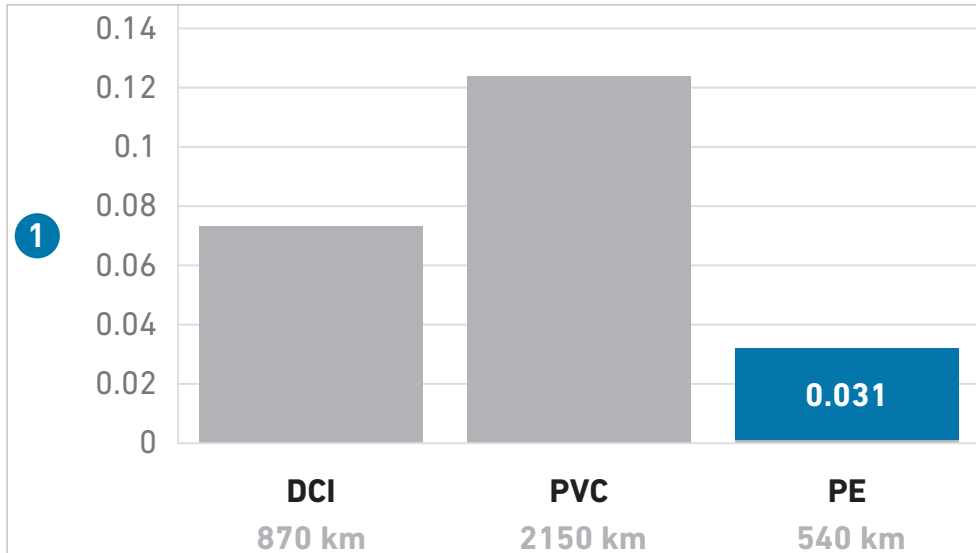

Damage statistics for the earthquake in Japan (2011)

Source: Damage report in Tohoku for the Pacific marine earthquake in Tome, Kurihara & Osaki in 2011 – Calamity Science Institute

1 Damages/km

In many areas earthquakes are not an issue, but in Central Europe too, earth settlement occurs as a result of traffic loads or landslides after heavy rain, for example. Fused polyethylene piping systems are robust and flexible and are therefore immune to subsidence.

Another advantage of PE 100 piping systems is the internal load capacity.

- Mechanical internal load: from 1 bar negative pressure to 16 bar excess pressure (for water)
- Resistant to a host of media and chemicals (for this refer to the online tool “Chemical resistance” at www.gfps.com).
- Large application temperature range: In continuous operation at a constant operating temperature of over 20°C, however, it is necessary to apply the pressure reduction factors up to 40°C pursuant to EN 12201-1 Appendix A or the reduced service lives and reduced values of the working pressure up to 70°C pursuant to DIN 8074.

1.2.4 Secure complete piping system

Pipes and fittings made from polyethylene have already been successfully used in Europe by gas and water utilities since the 1950s. Of all the pipeline materials used by gas and water utilities, PE pipes and fittings are the most strongly protected by standards, and the manufacturer's product quality is regularly monitored by third parties.

The complete system in particular, consisting of resistive PE pipes, the PE moldings made of homogeneous material, and the reliable jointing technology (fusion) in lengths up to DN 1200 mm, allow for continuous and cost-effective use in all gas and water utilities applications.

The integral welding of the homogeneous connection points offers continuous density and thus a secure and reliable network of pipes.

In many countries, this complete system is topped off with certified welding training and guaranteed by repeated recertification.

The safety of the overall system is underpinned by the low damage rates of fused PE piping systems.

1.2.5 Corrosion resistant

Worldwide, corrosion in metal pipelines represents a major problem in water supply networks.

It accounts for two thirds of the damages and so generally represents the main cause of leaks in the pipeline network.

In polyethylene pipelines for the water and gas supply, corrosion isn't even an issue and the PE pipes are also resistant to aggressive soils.

Furthermore, when transporting drinking water, it does not exhibit any encrustation and the very smooth pipe interior results in virtually no pressure loss.

Time-consuming, retrospective protection of the fused connection point is unnecessary for PE pipelines, but where metal connections are used, e.g. adaptor unions made of PE on brass or steel, corrosion protection measures are required.



Source: Technical report 3R – Hessel, Schulte 09-2006

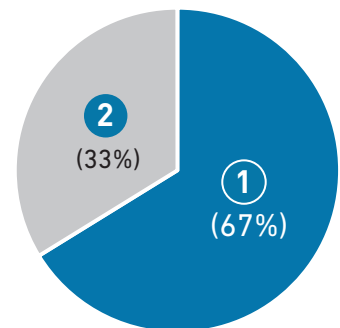

Network damage 2015

Source: SVGW W15001 (2017)

- 1 Corrosion
- 2 Other causes

1.2.6 Minimal abrasion

Transported solid parts (sand, rust etc.) in drinking water or gas lines often cause a significant amount of abrasion on the inner surface of pipes made of traditional materials, and therefore a reduction in their working life. The elastic properties of plastics provide for a cushioning effect on solid parts in the medium. Pipe systems made of polyethylene are characterized by very high abrasion resistance and, even with high flow rates, are practically abrasion-free.

This is why polyethylene pipelines are often used in the transportation of slurry and solids in mines and quarries.

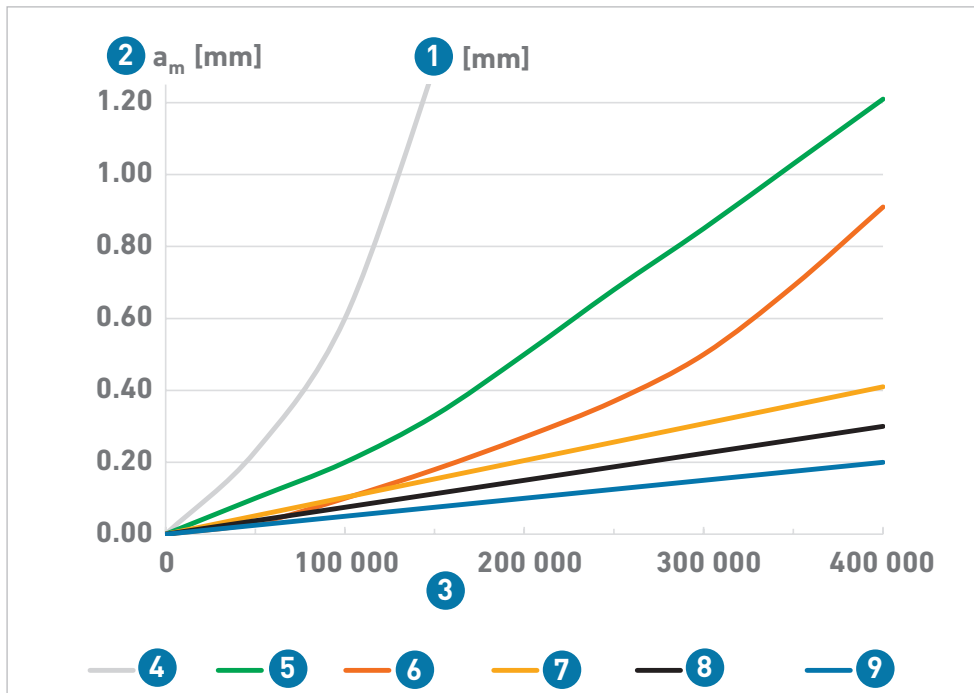

Abrasion [mm]

Source: Concrete, vitrified clay, GRP, and PE-HD from professional journal 3R international (2/3-97).

UPVC and PP from inspection report by ÖKI (Austrian plastics institute). Review no. 43.029

- 1 Abrasion
- 2 Medium abrasion
- 3 Number of load cycles
- 4 Concrete
- 5 GRP
- 6 Vitrified clay
- 7 PVC
- 8 PE
- 9 PP

1.2.7 Drinking water

Drinking water is the most important form of sustenance, so requirements for the pipes and piping components that transport it are correspondingly high. Pipes, moldings, and valves made of polyethylene meet all the chemical, technical, and hygienic demands required of them. Furthermore, they have already been guaranteeing the reliable transport of gas worldwide for decades. As part of the European drinking water approvals, each PE piping system component is tested organoleptically (for smell and taste without the use of aids) and analytically (chemically) for its suitability for drinking water (e.g. in accordance with KIWA "Publication 94-01" or KTW-BWGL and DVGW worksheet W 270).

Biofilm and drinking water quality

Biofilm cannot be prevented and is always present in the drinking water supply network across the board. Independent studies on the subject of biofilm (microbial growth) clearly show that, over an operating period of two years, colonization by microorganisms increases by roughly the same extent for all pipeline materials. However, increased water temperature and minimum flow/dead space are favorable conditions for the formation of biofilm and its proliferation. The use of disinfectant under practical conditions controls the scope of the biofilm formation but does not remove it completely. Biofilm on polyethylene is comparable with that on glass. The testing of our products according to DVGW worksheet W 270 certifies that, from a microbiological standpoint, PE is safe for use with drinking water.



1.2.8 Quick and simple laying

The low weight and the flexibility of polyethylene as a material, paired with modern trenchless installation methods and efficient jointing technology (particularly for butt fusion and electrofusion), provide for quick and simple installation. This has a positive impact on the installation costs thanks to the following factors:

- Simple handling (minimal expenditure for transport)
- Minimal size of pipe trench (low excavated material and backfilling costs)
- Minimal number of components (direct bending of the pipe to adjust to direction or pipeline route, use of weld saddles as junctions)
- Fast fusion cycles (minimal costs for the pipe jointing)
- Trenchless installation methods for the new build and relining process for renovation
- Big choice of plastic moldings and valves available

1.2.9 Low overall operating costs

Thames Water (one of the largest water utility companies in the UK) started a major project in 2004 renovating old drinking water transport lines. The enclosed report summarizes the main findings from this project.

For this, the total costs of a 5 km inner city pipeline with DN 400 mm (DI = ductile iron, GRP = glass fiber reinforced plastic) and DN 450 mm (PE 100/SFR17) were compared in London.

Across Europe, PE piping systems up to DN 250 mm within the distribution networks indisputably offer the most cost-effective solution. The total cost comparison by Thames Water, however, shows that even in the transmission pipeline range >DN 300 mm, polyethylene can be the most cost-effective solution of all possible pipe materials depending on the project.

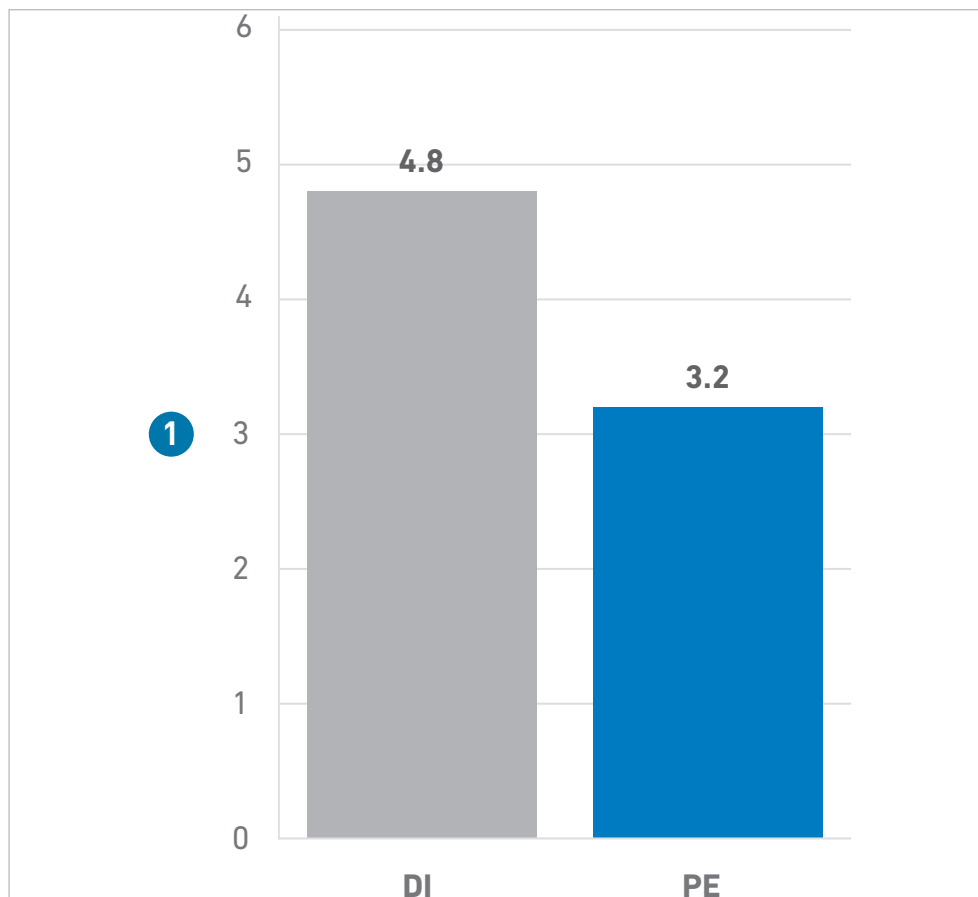

Working life costs: Representation of total cost of ownership for this project

DI Ductile iron

PE Polyethylene

Source: Borouge Technote 2013-04 "PE water systems have the lowest Whole Life Cost"

1 Total working life costs (million €)

1.3 Sustainability

The “Vito” institute (Flemish Institute of Technology) carried out life cycle assessments (LCAs) on behalf of Teppfa (the European Plastic Pipes and Fittings Association) for polyethylene piping systems and a cast iron pipe system in the utility sector. The results were summarized in Environmental Product Declarations (EPDs) and were also the subject of a critical review by the company “denkstatt”.

The findings show that piping systems made of polyethylene have five times less impact on the environment than those made of traditional materials.

The presented results are “cradle to grave” and therefore reflect the environmental impact from production of the raw material through to the end of the pipeline’s service life.

Additional information, including environmental product declarations, third-party reports, and the critical review of the life cycle assessments conducted by Vito, can be found in English on the Teppfa website: www.teppfa.eu

Plastics save energy

In addition to the above-mentioned technical advantages such as corrosion resistance, there are also environmental advantages to plastics. With their lightweight and insulating effect, plastics are suitable for a multitude of energy-efficient applications: in vehicles, for packaging, in insulation, and for piping systems. Plastics are produced primarily using crude oil. Roughly four percent of the crude oil produced worldwide is processed into plastics. Efforts to reduce the consumption of crude oil and other fossil fuels do not, however, mean an abandonment of plastics – on the contrary: Less energy is consumed by using plastics!

In a study¹, Plastics Europe quantified how energy consumption and greenhouse gas emissions would change if plastic products were to be replaced by other materials.

Results of the study

- Products made of plastic enable significant savings in energy and greenhouse gas emissions.
- In most cases, replacing plastic products with other materials leads to an increase in energy consumption and greenhouse gas emissions.

If as many plastic products as possible were to be replaced with other materials, over 50 % more energy would be required than the energy currently being consumed during the entire life cycle of all plastic products. In other words: The plastic products that are currently on the market have enabled energy savings of 2400 million GJ per year. This equates to a quantity of 50 million tons of crude oil, enough to fill 200 very large oil tankers.

1. More details on this study are available here: <https://www.plasticseurope.org/en/resources/publications/167-impact-plastic-packaging-energy-consumption-and-ghg-emissions>

To further improve the carbon footprint of plastic pipes, the key is a reduction in the demand for material. This applies to the development of piping components as well as to users and planning engineers. For this, we apply the following methods:

- Further cuts in the demand for material
- Use of regrinds and reused material for parts with low loads
- No over-dimensioning during planning (e.g. diameter, pressure level)

2 Approvals and standards

2.1 Approvals of products

Various approvals are in place for all piping systems made by GF Piping Systems. The most important approvals for our systems made of PE are listed in the following overview. The current status of the approvals can be obtained from the relevant GF Piping Systems office.

Abbreviation	Approval authority	Approved product range	Material
ABS	American Bureau of Shipping	Pipes, fittings, valves	ABS, PE, PVC-U, PVC-C
ACS	Attestation de Conformité Sanitaire	Fittings	PE
BSI	BSI Assurance UK Limited	Fittings	PE, malleable cast iron
BULAQUA	Bulaqua Standard	Fittings	PE
BV	Bureau Veritas	Pipes, fittings, valves	ABS, PE, PP-H, PVC-C, PVC-U
NF	CERTIgaz	Fittings	PE
DIBt	Deutsches Institut für Bau-technik [German institute for construction technology]	Pipes, fittings, valves	PVC-U, PP-H, PVDF, PE (fittings)
DNV GL	Det Norske Veritas	Pipes, fittings, valves	ABS, PE, PP-H, PVC-C, PVC-U
DVGW	Deutscher Verein des Gas- und Wasserfaches [German association for gas and water]	Gaskets Pipes, fittings, valves	EPDM, NBR PE, PP-H, PVC-C, PVC-U, malleable cast iron
FLUVIUS	Fluvius System Operator CV	Fittings	PE
ETI	Estonia Technical Inspectorate	Fittings, valves	PE
FM	FM Approvals	Pipes, fittings	PE
GAS	GAS s.r.o.	Fittings	PE
Global Mark	Global Mark	Fittings	PE
GOST-R	Rosstandart	Pipes, fittings, valves	ABS, PB, PE, PP, PVC-C, PVC-U, PVDF
GRDF	Gaz Réseau Distribution France	Fittings	PE
IGH	Institut IGH d.d.	Fittings	PE
IKRAM	Ikram QA Services SDN BHD	Fittings	PE
INSTA-CERT	Dancert S/A	Fittings	PE
ITC	Institut pro testování a certifikaci	Fittings	PE
KCW	Korea Water and Wastewater Works Association	Fittings	PE
KIWA KIWA Gastec KIWA UNI	Keuringsinstituut voor Waterleidingsartikelen	Fittings	PE, PVC-U PE, malleable cast iron
KTW / W270	Kunststoff-Trinkwasser-Empfehlungen	Gaskets Fittings	EPDM, NBR PE, PVC-U
LR	Lloyd's Register of Shipping	Pipes, fittings, valves	ABS, PE, PVC-U, PVC-C, PP-H
NK	Nippon Kaiji Kyokai	Pipes, fittings, valves	ABS, PB, PE, PP, PVC-C, PVC-U
NIGC	National Iranian Gas Co.	Fittings	PE
NSF	National Sanitary Foundation	Fittings	PE
ON	Österreichisches Normungsinstitut [Austrian Standards Institute]	Fittings	PE
ÖVGW	Österreichische Vereinigung für das Gas- und Wasserfach [Austrian association for gas and water]	Gaskets Pipes, fittings, valves	EPDM, NBR PE, PP, PVDF, malleable cast iron

Abbreviations and approvals (status: 12/2021)

Abbreviation	Approval authority	Approved product range	Material
PAEW	Oman Public Authority for Electricity and Water	Fittings, machines	PE
RINA	Registro Italiano Navale	Pipes, fittings, valves	ABS, PE, PP-H, PVC-C, PVC-U
RMROS	Russian Maritime Register of Shipping	Pipes, fittings, valves	ABS, PE, PVC-C, PVC-U
RTN	ROSTECHNADZOR	Pipes, fittings, valves, machines	ABS, PB, PE, PP, PVC-C, PVC-U, PVDF
SEPRO	Niko Sepro OS, Ukraine	Fittings, valves	PE
SVGW	Schweizerischer Verein des Gas- und Wasserfaches [Swiss association for gas and water]	Gaskets Fittings, valves	EPDM, NBR PB, PE, PP, malleable cast iron
VUSAPL	Vusapl, Slovakia	Fittings	PE
VUZ	Vyskumny Ustav Zvaracsky, Slovakia	Machines	-
WRAS	Water Regulations Advisory Scheme, Water Byelaws Scheme	Gaskets Pipes, fittings	EPDM, NBR ABS, PE, PVC-U, PVC-C

2.2 Standards and guidelines

2.2.1 Relevant standards and guidelines for pipes and fittings made of PE

Standard	Description
ISO 4427-1	Plastic piping systems – polyethylene (PE) pipes and fittings for the water supply – Part 1: General
ISO 4427-2	Plastic piping systems – polyethylene (PE) pipes and fittings for the water supply – Part 2: Pipes
ISO 4427-3	Plastic piping systems – polyethylene (PE) pipes and fittings for the water supply – Part 3: Fittings
ISO 4427-5	Plastic piping systems – polyethylene (PE) pipes and fittings for the water supply – Part 5: Fitness for purpose of the system
ISO 4437-1	Plastic piping systems for the transport of gaseous fuels – polyethylene (PE) – Part 1: General
ISO 4437-2	Plastic piping systems for the transport of gaseous fuels – polyethylene (PE) – Part 2: Pipes
ISO 4437-3	Plastic piping systems for the transport of gaseous fuels – polyethylene (PE) – Part 3: Fittings
ISO 4437-5	Plastic piping systems for the transport of gaseous fuels – polyethylene (PE) – Part 5: Fitness for purpose of the system
ISO 9623	PE/metal and PP/metal adaptor fittings for pressure pipes for liquids – design lengths and thread sizes – metric series
ISO 17885	Plastic piping systems – mechanical fittings for pressure piping systems – specifications
EN ISO 15494	Plastic piping systems for industrial applications – polybutene (PB), polyethylene (PE), polyethylene with increased temperature resistance (PE-RT), cross-linked polyethylene (PE-X), polypropylene (PP) – metric series for requirements for piping parts and the piping system.
EN 1555-1	Plastic piping systems for the gas supply – polyethylene (PE) – Part 1: General
EN 1555-2	Plastic piping systems for the gas supply – polyethylene (PE) – Part 2: Pipes
EN 1555-3+A1	Plastic piping systems for the gas supply – polyethylene (PE) – Part 3: Fittings
EN 1555-5	Plastic piping systems for the gas supply – polyethylene (PE) – Part 5: Fitness for purpose of the system
CEN/TS 1555-7	Plastic piping systems for the gas supply – polyethylene (PE) – Part 7: Guidance for assessment of conformity
EN 12201-1	Plastic piping systems for the water supply and for drainage and sewerage under pressure – polyethylene (PE) – Part 1: General
EN 12201-2+A1	Plastic piping systems for the water supply and for drainage and sewerage under pressure – polyethylene (PE) – Part 2: Pipes

Standards and guidelines for pipes and fittings made of PE (status: 12/2021)



Standard	Description
EN 12201-3+A1	Plastic piping systems for the water supply and for drainage and sewerage under pressure – polyethylene (PE) – Part 3: Fittings
EN 12201-5	Plastic piping systems for the water supply and for drainage and sewerage under pressure – polyethylene (PE) – Part 5: Fitness for purpose of the system
CEN/TS 12201-7	Plastic piping systems for the water supply and for drainage and sewerage under pressure – polyethylene (PE) – Part 7: Guidance for assessment of conformity
AS/NZS 4129	Fittings for polyethylene (PE) pipes for pressure applications

2.2.2 Relevant standards and guidelines for processing

Standard	Description
ISO/TS 10839	Polyethylene pipes and fittings for the gas supply – code of practice for design, handling, and installation
ISO 12176-1	Plastic pipes and fittings – equipment for fusion connections in polyethylene systems – Part 1: Butt fusion
ISO 12176-2	Plastic pipes and fittings – equipment for fusion connections in polyethylene systems – Part 2: Electrofusion
ISO 12176-3	Plastic pipes and fittings – equipment for fusion connections in polyethylene systems – Part 3: Operator's badge
ISO 12176-4	Plastic pipes and fittings – equipment for fusion connections in polyethylene systems – Part 4: Traceability coding
EN 12007-2	Gas infrastructure – pipelines with maximum permitted working pressure up to and including 16 bar – Part 1: General functional requirements
PAS 1075	Pipes made from polyethylene for alternative installation techniques – measurements, technical requirements, and testing
DVS 2202	Evaluation of joints between thermoplastics on piping parts and panels – characteristics, description, evaluation
DVS 2202 supplement-1	Evaluation of imperfections in joints made of thermoplastic materials connecting to piping parts and panels – heated plate welding (HS, IR)
DVS 2202 supplement-2	Evaluation of imperfections in joints made of thermoplastic materials connecting to piping parts and panels – electrofusion welding (HM)
DVS 2205-1 supplement 6	Calculation of containers and apparatus made of thermoplastics – welding factors
DVS 2207-1	Fusioning of thermoplastics – heated tool fusion of pipes, pipeline components, and sheets made of PE-HD
DVS 2210-1	Industrial pipelines made of thermoplastics – planning and execution – above-ground pipe systems
DVS 2210-1 supplement 1	Industrial piping made of thermoplastics – planning and execution – above-ground pipe systems; calculation example
DVS 2210-1 supplement 2	Industrial piping made of thermoplastics – planning and execution – above-ground pipe systems; recommendations for the internal pressure and leak tests
DVS 2210-1 supplement 3	Industrial pipelines made of thermoplastics – planning and execution – above-ground pipe systems – flange connections: description, requirements, and assembly
DVS 2210-2	Industrial piping made of thermoplastics – planning, light-weight design, and installation – two-pipe systems

Relevant standards and guidelines for processing (status: 12/2021)

2.2.3 Relevant standards and guidelines for valves

Standard	Description
EN 1555-4	Plastic piping systems for the gas supply – polyethylene (PE) – Part 4: Valves
EN 12201-4	Plastic piping systems for the water supply and for drainage and sewerage under pressure – polyethylene (PE) – Part 4: Valves
EN 593	Industrial valves – metallic butterfly valves
EN ISO 16135	Industrial valves – ball valves made of thermoplastic materials
EN ISO 16136	Industrial valves – shut-off valves made of thermoplastic materials
EN ISO 16137	Industrial valves – backflow preventers made of thermoplastic materials
EN ISO 16139	Industrial valves – gate valves made of thermoplastic materials
EN ISO 21787	Industrial valves – valves made of thermoplastic materials
ISO 4437-4	Plastic piping systems for transport of gaseous fuels – polyethylene (PE) – Part 4: Valves

Standards and guidelines for valves (status: 12/2021)

2.2.4 Relevant standards and guidelines for flanges and gaskets

Standard	Description
EN 681-1	Elastomer gaskets – material requirements for pipeline gaskets used in the water supply and drainage applications – Part 1: Vulcanized rubber
EN 681-2	Elastomer gaskets – material requirements for pipeline gaskets used in the water supply and drainage applications – Part 1: Thermoplastic elastomers
ISO 7005-1	Metal flanges; Part 1: Steel flanges
ISO 7005-2	Metal flanges; Part 2: Cast iron flanges
ISO 7005-3	Metal flanges; Part 3: Copper alloy and composite flanges
ISO 7483	Dimensions of gaskets for use with flanges according to ISO 7005
ISO 7483 Technical Corrigendum 1	Dimensions of gaskets for flanges according to ISO 7005; Technical Corrigendum 1
ISO 9624	Thermoplastics piping systems for fluids under pressure – flange adaptors and loose backing flanges – mating dimensions
EN ISO 15494	Plastic piping systems for industrial applications – polybutene (PB), polyethylene (PE), polyethylene with increased temperature resistance (PE-RT), cross-linked polyethylene (PE-X), polypropylene (PP) – metric series for requirements for piping parts and the piping system
EN 558+A1	Industrial valves – structural length of metal valves for assembly in flanged pipe systems – PN and class-designated valves
EN 1092-1+A1	Flanges and their joints – circular flanges for pipes, valves, fittings, and accessories, PN-designated – Part 1: Steel flanges
EN 1092-2	Flanges and their joints – circular flanges for pipes, valves, fittings, and accessories, PN-designated – Part 2: Cast iron flanges
EN 1514-8	Flanges and their joints – dimensions of gaskets for PN-designated flanges Part 8: Rubber O-ring gaskets for grooved flanges
EN 1515-1	Flanges and their joints – screws and nuts – Part 1: Selection of screws and nuts
ASME B16.5	Pipe flanges and flanged fittings: NPS 1/2 through NPS 24 metric/inch standard
BS 10:2009	Specification for flanges and bolting for pipes, valves, and fittings
DVS 2205-4	Calculation of thermoplastic containers and apparatuses – flanged connections
DVS 2205-4 supplement 4	Calculation of thermoplastic containers and apparatuses – fused flanges, fused collars – structural details
DVS 2210-1 supplement 3	Industrial pipelines made of thermoplastics – planning and execution – above-ground pipe systems – flange connections: description, requirements, and assembly
JIS B 2220	Steel pipe flanges
JIS B 2239	Cast iron pipe flanges

Standards and guidelines for flanges (status: 12/2021)

2.2.5 Relevant standards and guidelines for threads

Standard	Description
EN ISO 228-1	Pipe thread for connections that do not seal in the thread – Part 1: Dimensions, tolerances, and designation
EN 10226-1	Pipe thread for connections that seal in the thread – Part 1: Tapering male threads and cylindrical internal threads – dimensions, tolerances, and designation
EN 10226-2	Pipe thread for connections that seal in the thread – Part 2: Tapering male threads and tapering internal threads – dimensions, tolerances, and designation

Standards and guidelines for threads (status: 12/2021)

2.2.6 Relevant standards and guidelines for malleable cast iron compression joints

Standard	Description
ISO 17885	Plastic piping systems – mechanical fittings for pressure piping systems – specifications
EN 10284	Malleable cast iron fittings with compression ends for polyethylene (PE) piping systems
EN 10344	Malleable cast iron fittings with compression ends for steel pipes

Design and laying

Content

1	Basic knowledge	43
1.1	Metric and British system of units.....	43
1.2	Abbreviations and units of measure.....	44
1.3	SI-units.....	45
1.4	Conversion tables.....	47
2	Design	49
2.1	Long-term behavior of thermoplastic materials.....	49
2.2	Application range for pipes and fittings.....	53
2.3	Calculation of allowable pressure/required wall thickness.....	55
2.4	Water hammer.....	57
2.5	Pipelines under vacuum.....	61
3	Hydraulic calculation and pressure losses	62
3.1	Hydraulic calculation.....	62
3.2	Diffusion.....	65
4	Laying	66
4.1	Health and safety at work.....	66
4.2	Construction site logistics and planning.....	67
4.3	Requirements for personnel, material and cleanliness.....	68
4.4	Open pipe trench.....	69
4.5	Trenchless laying process.....	72
4.6	Processing and handling.....	74
4.7	Internal pressure and leak test.....	78
4.8	Installation.....	80
4.9	Repairs during operation.....	81

5	Integral jointing technology (welding)	85
5.1	Integral connections.....	85
5.2	Butt fusion heating element.....	86
5.3	Heating coil/electric jointing.....	95
5.4	Installation process.....	99
5.5	Cooling times.....	103
5.6	Installation guidelines and fault prevention.....	105
6	Mechanical jointing technology	109
6.1	Overview.....	109
6.2	Transition adaptor.....	110
6.3	MULTI/JOINT® 3000 Plus – multi-range fitting with a restraint pull-out resistance system.....	112
6.4	Flange connections.....	117
6.5	Multi/clamp.....	123
6.6	UNI-Coupling – repair couplings.....	124
6.7	PRIMOFIT compression joints.....	128
6.8	iJOINT – compression joints.....	131
6.9	PP saddles.....	134

1 Basic knowledge

1.1 Metric and British system of units

The essential difference between the metric and the British system of units lies in that one is based on the nominal diameter and the other on the outside diameter. The metric system of units utilizes the outside diameter and the values are given in mm. The British system utilizes the nominal diameter of the pipe and uses the inch system of units and fractions thereof.

Conversions of metric and British system of units

Metric sizes		Inch sizes	
Pipe outside diameter dn (mm)	Nominal diameter DN (mm)	Nominal diameter DN (inches)	Pipe outside diameter dn (mm)
10	6	1/8	10.2
12	8	1/4	13.5
16	10	3/8	17.2
20	15	1/2	21.3
25	20	3/4	26.9
32	25	1	33.7
40	32	1 1/4	42.4
50	40	1 1/2	48.3
63	50	2	60.3
75	65	2 1/2	75.3
90	80	3	88.9
-	-	3 1/2	101.6
110	100	4	114.3
125	100	-	-
140	125	5	140.3
160	150	6	168.3
180	150	-	-
200	200	8	219.1
225	200	8	219.1
250	250	9	244.5
280	250	10	273.0
315	300	12	323.9
355	350	14	355.6
400	400	16	406.4
450	450	18	457.2
450	500	20	508.0
500	500	20	508.0
560	600	22	558.2
630	600	24	609.6
-	-	26	660.4
710	700	28	711.2
-	-	30	762.0
800	800	32	812.8
-	-	34	863.6
900	900	36	914.4
1000	1000	40	1016.0
1200	1200	48	1219.2
1400	1400	56	1422.4
1600	1600	64	1625.6
2000	2000	80	2032.0

1.2 Abbreviations and units of measure

1.2.1 Abbreviations for materials

Abbreviation	Description
ABS	Acrylonitrile-butadiene-styrene
CR	Chloroprene rubber, e.g. neoprene
EPDM	Ethylene propylene rubber
FKM	Fluororubber
GRP	Glass-reinforced plastics
MCI	Malleable cast iron
Ms	Brass
NBR	Nitrile rubber
NR	Natural rubber
PB	Polybutylene
PE	Polyethylene
PE-X	Crosslinked polyethylene
POM	Polyoxymethylene (also polyacetal)
PP	Polypropylene
PTFE	Polytetrafluorethylene
PVC	Polyvinyl chloride
PVC-C	Post-chlorinated polyvinyl chloride (increased chlorine content)
PVDF	Polyvinylidene fluoride
UPVC	Polyvinyl chloride, plasticizer-free
UP-GF	Unsaturated polyester resin, fiberglass-reinforced

1.2.2 Abbreviations for procedures

Abbreviation	Description	
C	Design factor	Coefficient with a value greater than one, which takes account of both the operating conditions and the properties of the components of a piping system not yet recorded in the lower confidence limit.
S	Pipe series	Dimensionless key figure for designating pipes; $S = (SDR-1)/2$
SDR	Standard dimension ratio Diameter wall thickness ratio	Whole-number numeric key figure for a pipe series that approximately corresponds to the ratio between the nominal outside diameter of a pipe and its nominal wall thickness
MFR	Melt flow rate (melt mass-flow rate)	Value that relates to the viscosity of a melted mass that is pressed through a die with a particular weight at a predefined temperature
MRS	Minimum required strength	Value of σ_{LCL} (lower confidence limit of the predicted resistance to internal pressure) at 20 °C and 50 years

1.2.3 Abbreviations for dimensions and units

Abbreviation	Description
d, d1, d2, d3, d4	Outside diameter
DN	Nominal diameter
d_n	Nominal outside diameter (EN 1555/EN 12201)
SC	Size of hexagon head screws
AL	Number of bolt holes
s	Wrench size
g	Weight in grams
e	Pipe wall thickness
PN	Nominal pressure at 20 °C, water
Rp	Cylindrical inner pipe thread acc. to ISO 7-1
R	Conical outer pipe thread acc. to ISO 7-1
ppm	Parts per million
1 bar	= 0.1 N/mm ² = 0.1 MPa = 14.504 psi

Dimensions must be listed in mm and/or inches and refer to nominal or standard dimensions.

Subject to changes in construction and light-weight design.

1.3 SI-units

1.3.1 SI base units

Basic size name	Sign	SI base units name	Sign
Length	l	Meter	m
Mass	m	Kilogram	kg
Time	t	Second	s
Electric current	l	Ampere	A
Thermodynamic temperature	T	Kelvin	K
Amount of substance	n	Mole	mol
Luminous intensity	ln	Candela	cd

1.3.2 Internationally defined prefixes

Meaning	Prefix name	Sign	Factor as Decimal power	Decimal number
Quintillion	exa	E	10 ¹⁸	= 1 000 000 000 000 000 000
Quadrillion	peta	P	10 ¹⁵	= 1 000 000 000 000 000
Trillion	tera	T	10 ¹²	= 1 000 000 000 000
Billion	giga	G	10 ⁹	= 1 000 000 000
Million	mega	M	10 ⁶	= 1 000 000
Thousand	kilo	k	10 ³	= 1 000
Hundred	hecto	h	10 ²	= 100
Ten times	deca	da	10 ¹	= 10
Tenth	deci	d	10 ⁻¹	= 0.1
Hundredth	centi	c	10 ⁻²	= 0.01
Thousandth	milli	m	10 ⁻³	= 0.001
Millionth	micro	μ	10 ⁻⁶	= 0.000 001
Billionth	nano	n	10 ⁻⁹	= 0.000 000 001
Trillionth	pico	p	10 ⁻¹²	= 0.000 000 000 001
Quadrillionth	femto	f	10 ⁻¹⁵	= 0.000 000 000 000 001
Quintillionth	atto	a	10 ⁻¹⁸	= 0.000 000 000 000 000 001

1.3.3 Units

Size	Sign	SI-unit	Permissible units outside of SI	Conversion into corresponding SI unit and relationships	Units and conversions no longer permissible
Length	l	m			1" = 0.0254 m 1 Sm = 1852 m
Area	A	m ²			1 b = 10 ⁻²⁸ m ² 1 a = 10 ² m ² 1 ha = 10 ⁴ m ² sqm, sqdm, sqcm
Volume	V	m ³	l	1 l = 10 ⁻³ m ³	
Solid angle	Ω	SR		1 sr = 1 m ² /m ²	1° = 3.046 • 10 ⁻⁴ sr 1 g = 2.467 • 10 ⁻⁴ sr
Time	t	s	min h d	1 min = 60 s 1 h = 3600 s 1 d = 86 400 s	
Frequency	f	Hz		1 Hz = 1/s	
Rotational speed, rotational frequency	n	s ⁻¹	min ⁻¹ U/min	1 min ⁻¹ (1/60) s ⁻¹ 1 U/min = 1 (1/min)	
Velocity	v	m/s	km/h	1 km/h = (1/3.6) m/s	
Acceleration	g	m/s ²		Standard gravitational acceleration g _n = 9.80665 m/s ²	1 Gal = 10 ⁻² m/s ²
Mass	m	kg	t	1 t = 10 ³ kg	1 q = 50 kg
Density	ρ	kg/m ³	t/m ³ kg/l	1 t/m ³ = 1000 kg/m ³ 1 kg/l = 1000 kg/m ³	
Moment of inertia	J	kg • m ²			1 kp • m s ² = 9.81 kg • m ²
Force	F	N		1 N = 1 kg • m/s ²	1 dyn = 10 ⁻⁵ N 1 p = 9.80665 • 10 ⁻³ N 1 kp = 9.80665 N
Torque	M	N • m			1 kpm = 9.80665 Nm 1 Nm = 0.7375 lb-ft
Thrust	p	Pa	bar	1 Pa = 1 N/m ² 1 bar = 10 ⁵ Pa	1 atm = 1.01325 bar 1 at = 0.980665 bar 1 Torr = 1.333224 • 10 ⁻³ bar 1 m WS = 98.0665 • 10 ⁻³ bar 1 mm Hg = 1.333224 • 10 ⁻³ bar
Mechanical stress	σ	N/m ² Pa		1 N/m ² = 1 Pa	1 kp/m ² = 9.80665 N/m ² 1 kp/cm ² = 98.0665 • 10 ⁻³ N/m ² 1 kp/mm ² = 9.80665 • 10 ⁻⁶ N/m ²
Dynamic viscosity		Pa • s		1 Pa • s = 1 N • s/m ²	1 P (poise) = 10 ⁻¹ Pa • s
Kinematic viscosity		m ² /s		1 m ² /s = 1 Pa • s • m ³ /kg	1 St (stokes) = 10 ⁻⁴ m ² /s
Work energy	W E	J	eV W • h	1 J = 1 Nm = 1 WS 1 W • h = 3.6 KJ	1 cal = 4.1868 J 1 kpm = 9.80665 J 1 erg = 10 ⁻⁷ J
Electric charge	Q	C		1 C = 1 A • s	
Electric voltage	U	V		1 V = 1 W/A	
Electric current	I	A			
Electric resistance	R	Ω		1 Ω = 1 V/A	1 Ω abs = 1 Ω
Performance	P	W		1 W = 1 J/s = 1 Nm/s 1 W = 1 V • A	1 PS = 735.498 W 1 kcal/h = 1.163 W 1 kpm/s = 10 W
Electric capacitance	C	F		1 F = 1 C/V	
Magnetic field strength	H	A/m			1 Oe = 79.5775 A/m
Magnetic flux	Φ	Wb		1 Wb = 1 V • s	1 Mx = 10 ⁻⁸ Wb

Size	Sign	SI-unit	Permissible units outside of SI	Conversion into corresponding SI unit and relationships	Units and conversions no longer permissible
Magnetic flux density	B	T		1 T = 1 Wb/m ²	1 G = 10 ⁻⁴ T
Inductance	L	H		1 H = 1 Wb/A	
Electric conductance	G	S		1 S = 1/Ω	
Thermodynamic temperature	T	K		Δ 1 °C = Δ 1 K 0 °C = 273.15 K	
Celsius temperature	t, δ	°C		Δ 1 °C = Δ 1 K 0 K = -273.15 °C	
Thermal capacity	C	J/K			1 Kcl/grad = 4.1868 10 ⁻³ J/K 1 Cl = 4.1868 J/K

1.4 Conversion tables

1.4.1 Viscosities

Kinematic viscosity Centistokes density	Absolute viscosity Centipoise	Degree Engler	Saybolt Universal second (SSU)	Redwood 1 second (standard)	Saybolt Furol second	Ford Cup No. 4 second	Degree Barbey	Cup No. 15 second	Absolute viscosity Poise density 1.0	Kinematic viscosity m ² /s
1.0	1.0	1.0	31	29	-	-	-	-	0.01	1.0 x 10 ⁻⁶
2.0	2.0	1.1	34	30	-	-	3640	-	0.02	2.0 x 10 ⁻⁶
3.0	3.0	1.2	35	33	-	-	2426	-	0.03	3.0 x 10 ⁻⁶
4.0	4.0	1.3	37	35	-	-	1820	-	-	4.0 x 10 ⁻⁶
5.0	5.0	1.39	42	38	-	-	1300	-	0.05	5.0 x 10 ⁻⁶
6.0	6.0	1.48	45.5	40.5	-	-	1085	-	0.06	6.0 x 10 ⁻⁶
7.0	7.0	1.57	48.5	43	-	-	930	-	0.07	7.0 x 10 ⁻⁶
8.0	8.0	1.65	53	46	-	-	814	-	0.08	8.0 x 10 ⁻⁶
9.0	9.0	1.74	55	48.5	-	-	723	-	0.09	9.0 x 10 ⁻⁶
10	10	1.84	59	52	-	-	650	-	0.10	1.0 x 10 ⁻⁵
20	20	2.9	97	85	15	-	320	-	0.2	2.0 x 10 ⁻⁵
40	40	5.3	185	163	21	-	159	-	0.4	4.0 x 10 ⁻⁵
60	60	7.9	280	245	30	18.7	106	5.6	0.6	6.0 x 10 ⁻⁵
80	80	10.5	370	322	38	25.9	79	6.7	0.8	8.0 x 10 ⁻⁵
100	100	13.2	472	408	47	32	65	7.4	1.0	1.0 x 10 ⁻⁴
200	200	26.4	944	816	92	60	32.5	11.2	2.0	2.0 x 10 ⁻⁴
400	400	52.8	1888	1632	184	111	15.9	18.4	4.0	4.0 x 10 ⁻⁴
600	600	79.2	2832	2448	276	162	10.6	26.9	6.0	6.0 x 10 ⁻⁴
800	800	106	3776	3264	368	217	8.1	35	8.0	8.0 x 10 ⁻⁴
1000	1000	132	7080	4080	460	415	6.6	68	10	1.0 x 10 ⁻³
5000	5000	660	23 600	20 400	2300	1356	1.23	240	50	5.0 x 10 ⁻³
10 000	10 000	1320	47 200	40 800	4600	2713	-	481	100	1.0 x 10 ⁻²
50 000	50 000	6600	236 000	204 000	23 000	13 560	-	2403	500	5.0 x 10 ⁻²

Absolute viscosity (centipoise) = Kinematic viscosity (centistokes)

• density over 50 centistokes

- Conversion to SSU @ SSU

= centistokes • 4.62

1.4.2 Flow volume

m ³ /h	l/min	l/s	m ³ /s	Imp. gal/min	US gal/min	cu. ft./h	cu. ft./s
1.0	16.67	0.278	2.78•10 ⁻⁴	3.667	4.404	35.311	9.81 • 10 ⁻³
0.06	1.0	0.017	1.67 x 10 ⁻⁵	0.220	0.264	2.119	5.89 x 10 ⁻⁴
3.6	60	1.0	1.00 x 10 ⁻³	13.20	15.853	127.12	3.53 x 10 ⁻²
3600	60 000	1000	1.0	13 200	15 838	127 118	35.311
0.2727	4.55	0.076	7.58 x 10 ⁻⁵	1.0	1.201	9.629	2.67 x 10 ⁻³
0.2272	3.79	0.063	6.31 x 10 ⁻⁵	0.833	1.0	8.0238	2.23 x 10 ⁻³
0.0283	0.47	0.008	7.86 x 10 ⁻⁶	0.104	0.125	1.0	2.78 x 10 ⁻⁴
101.94	1699	28.32	2.83 x 10 ⁻²	373.77	448.8	3 600	1.0

1.4.3 Pressure and heads

bar	kg/cm ²	lbf/in ²	atm	ft H ₂ O	m H ₂ O	mm Hg	in. Hg	kPa
1.0	1.0197	14.504	0.9869	33.455	10.197	750.06	29.530	100
0.9807	1.0	14.223	0.9878	32.808	10	735.56	28.959	98.07
0.0689	0.0703	1.0	0.0609	2.3067	0.7031	51.715	2.036	6.89
1.0133	1.0332	14.696	1.0	33.889	10.332	760.0	29.921	101.3
0.0299	0.0305	0.4335	0.0295	1.0	0.3048	22.420	0.8827	2.99
0.0981	0.10	1.422	0.0968	3.2808	1.0	73.356	2.896	9.81
13.3 x 10 ⁻⁴	0.0014	0.0193	13.2 x 10 ⁻⁴	0.0446	0.0136	1.0	0.0394	0.133
0.0339	0.0345	0.4912	0.0334	1.1329	0.3453	25.40	1.0	3.39
1.0 x 10 ⁻⁵	10.2 x 10 ⁻⁶	14.5 x 10 ⁻⁵	9.87 x 10 ⁻⁶	3.34 x 10 ⁻⁴	10.2 x 10 ⁻⁵	75.0 x 10 ⁻⁴	29.5 x 10 ⁻⁵	1.0

atm International standard atmosphere

kg/cm² Metric atmosphere

2 Design

2.1 Long-term behavior of thermoplastic materials

One of the most important characteristics of plastic pipes is the realistic working life of a pipe that is subjected to internal pressure. This characteristic is referred to as creep rupture behavior. When determining the creep rupture behavior, the temperature and the flow medium play an essential role.

2.1.1 MRS-values

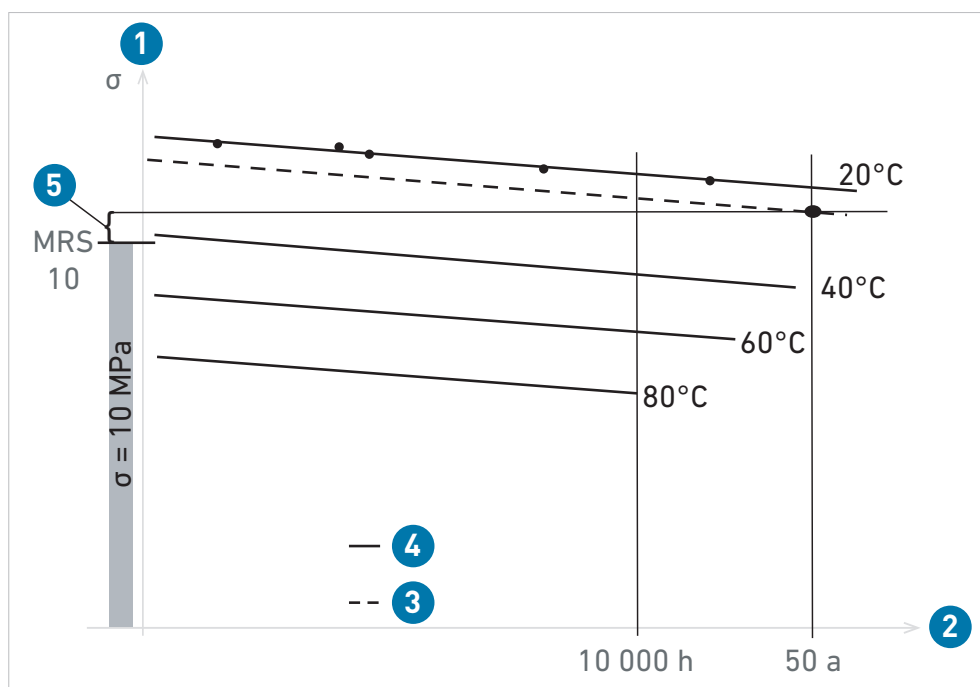

We differentiate between the properties relating to the creep rupture behavior of the pressure pipe plastics using a standardized classification system. The starting point for the classification is the determination of creep rupture diagrams and their evaluation according to the standard extrapolation method. The maximum stress is determined over time at constant temperature. The LTHS (long-term hydrostatic strength) expected value forms the theoretical curve for the determined test values. The stress determined in this way at 50 years (rounded to the next-lowest standard preferred number) forms the MRS (minimum required strength) value – the material-specific minimum strength.

Classification of PE materials

Material	MRS-value (MPa)	σ LCL
PE 63	6	6.3-7.99
PE 80	8	8.0-9.99
PE 100/PE 100-RC	10	10.0-11.19

2.1.2 Long-term behavior of PE

Calculation (based on EN ISO 15494: 2015)

The long-term behavior of PE of PE 80 and PE 100 is shown in the following long-term creep diagram. For the temperature range from +10 °C to +80 °C, lines of fracture are displayed. These are called LPL curves (Lower Predictable Limit); this means according to the definition that 97.5% of all fracture points are on or above the corresponding curve.

The representation of the curves is performed in a double logarithmic (i.e. non-linear) diagram; this should be noted when deducing stress or service life. The pressure-temperature diagram given for pipes and fittings made of PE 80 and PE 100 has been derived from the long-term creep diagram with inclusion of the design factor at a working life of 50 years.

The long-term creep diagram was determined using the extrapolation method according to EN ISO 9080. With the following equation (3-parameter model), which was derived from that diagram, stress, temperature or service life can be calculated for the temperature range of +10 °C to +80 °C.

First branch (in the following long-term creep diagrams)

PE 100

$$\log t = -45.4008 + 28444.734 \cdot \frac{1}{T} - 45.9891 \cdot \log \sigma$$

PE 80

$$\log t = -42.5488 + 24078.8 \cdot \frac{1}{T} - 37.5758 \cdot \log \sigma$$

t Time to failure (h)

T Medium temperature (K)

σ Hoop stress (MPa) (1 MPa = 1 N/mm²)

Regression curves for the long-term interior pressure behavior of PE 100/
PE 100-RC (EN ISO 15494: 2015)

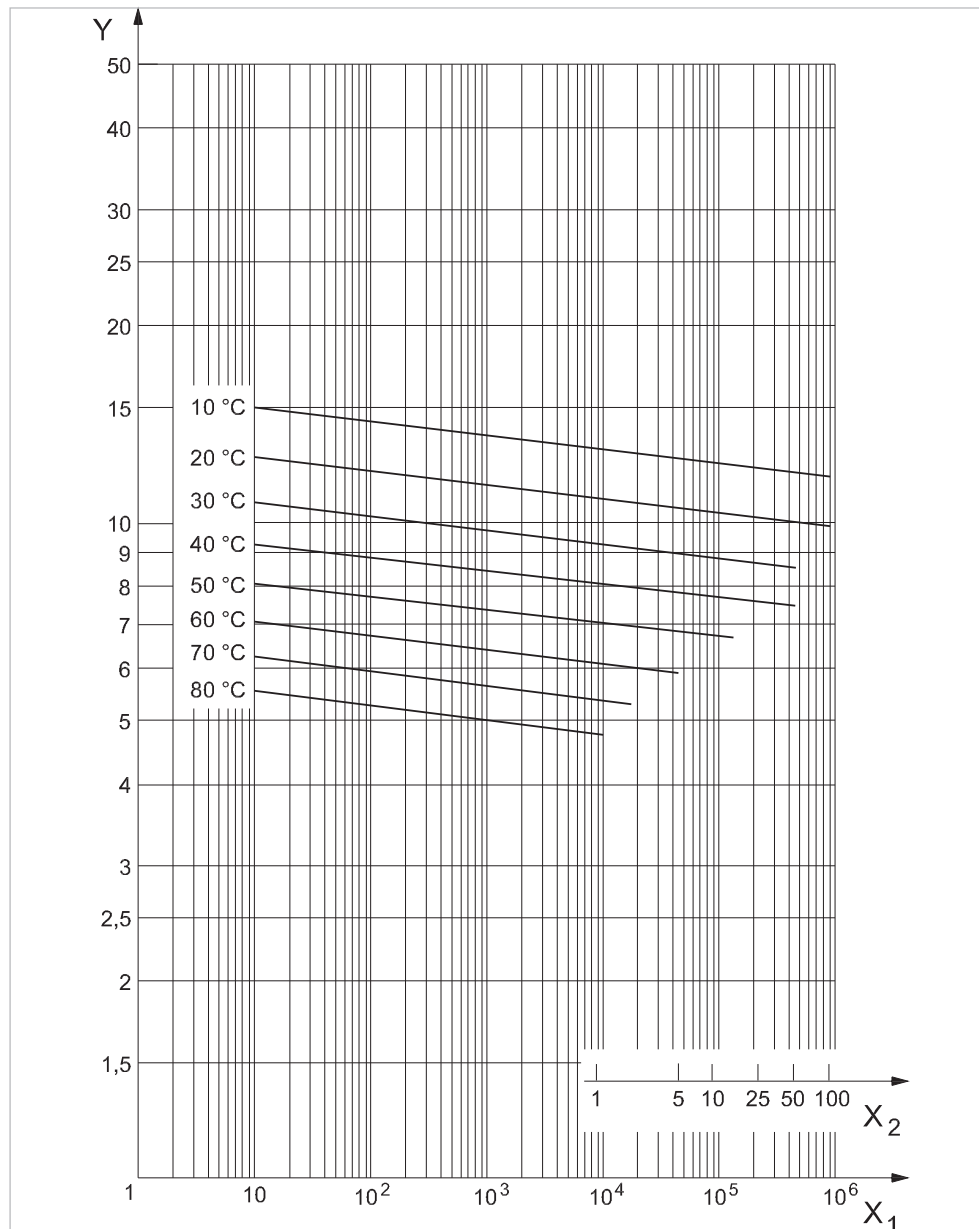

- X₁ Time to failure, in hours (h)
- X₂ Time to failure, in years
- Y Hoop stress, in mega-pascals (MPa)

Regression curves for the long-term interior pressure behavior of PE 80 (EN ISO 15494: 2015)

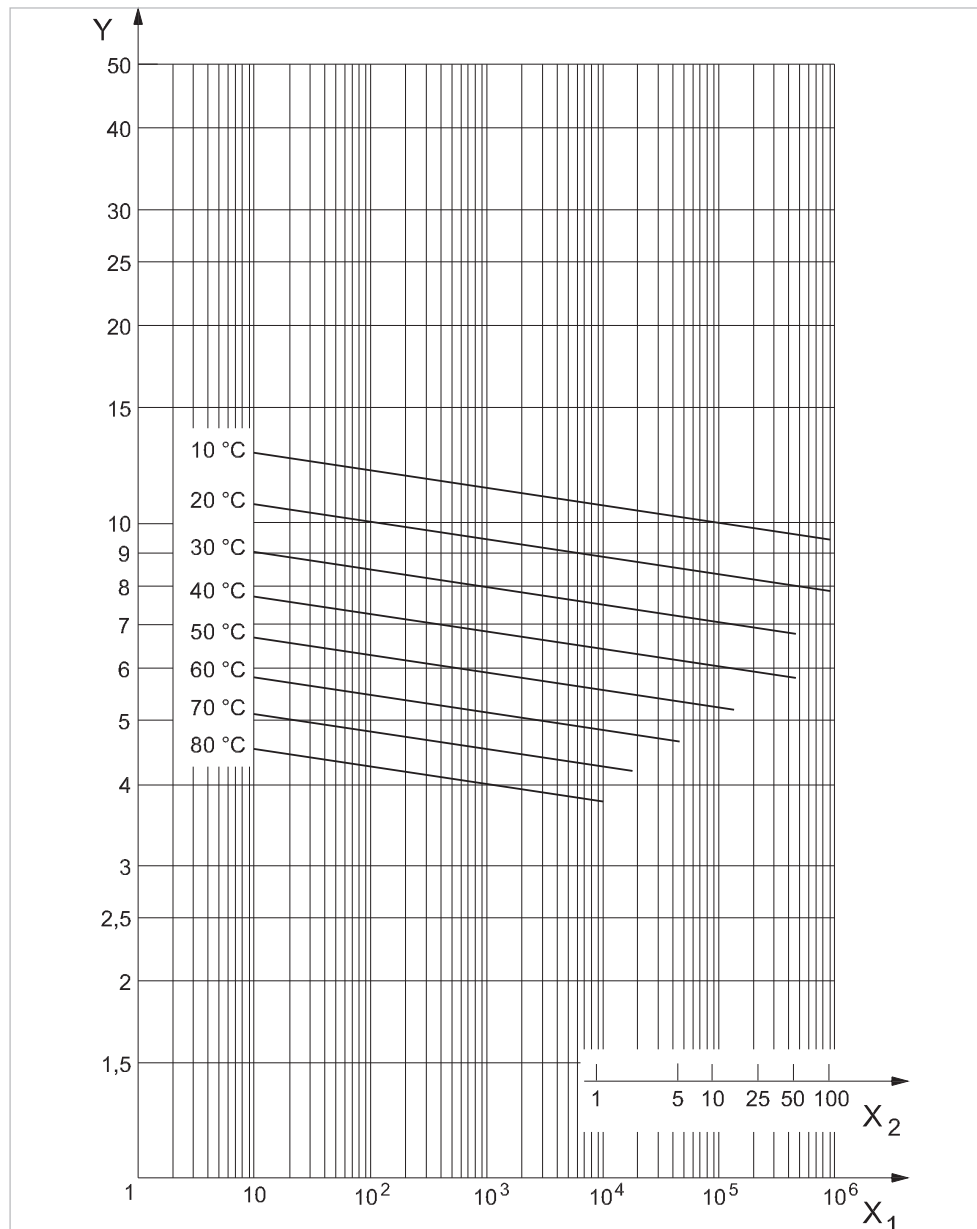

- X1** Time to failure, in hours (h)
- X2** Time to failure, in years
- Y** Hoop stress in megapascals (MPa)

2.2 Application range for pipes and fittings

2.2.1 In general

The choice of material and the pressure rating of the pipe components are important for both operational safety and for attaining the specified minimum service life of the system.

The decisive influencing factors are the following:

- Working pressure
- Operating temperature
- Medium transported
- Duration of stress

Separate calculations are necessary if design factors are different or the service life is modified. The suitability of the material to the flow medium, i.e. the chemical resistance, can be determined using the chemical resistance list provided separately by GF Piping Systems.

2.2.2 Pressure-temperature diagram for PE

PE 100

A PE system is designed based on average operating conditions, taking account of the maximum values. In contrast to metal pipelines, PE pipelines are designed with the aim of a guaranteed working life. The average operating conditions must be used as the basis for this.

If, for example, a line is exposed to a temperature of 40 °C for one month at the hottest time of the year, this is not the temperature used as the basis for the calculation. A more accurate value is the annual average temperature. As a result, the line is not overdimensioned and is instead designed exactly to meet the operating condition requirements. The design factors, described later, provide additional reliability.

The following pressure-temperature diagram for PE 100 pipes and fittings is valid for a service life of 50 years.

The design factor of 1.25 for water (EN 12201, ISO 4427) and 2.0 for gas (EN 1555, ISO 4437) is taken into account in this.

The diagram is applicable for the use of water or similar media, meaning media that do not have a reduction factor for chemical resistance.



Please take into account the pressure-temperature diagrams for valves and special fittings.

Because of the type and/or sealing material used, differences are possible in comparison to pipes and fittings. More information is available in the planning fundamentals of the relevant types of valves and special fittings.

Contact GF Piping Systems when operating in the dashed temperature range.

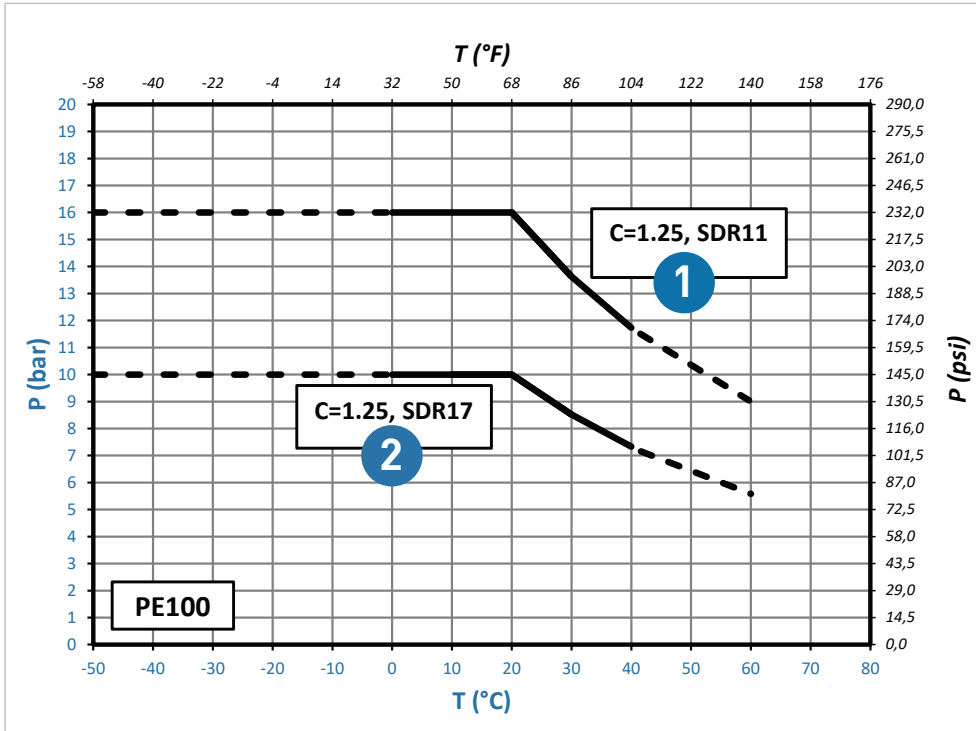

Pressure-temperature diagram for PE 100, water

- 1** Design factor C = 1.25, S5, SDR11 for 20 °C water, 50 years
- 2** Design factor C = 1.25, SDR17 for 20 °C water, 50 years
- P** Permissible pressure (bar, psi)
- T** Temperature (°C, °F)

Water curves limited to PN16 or PN10

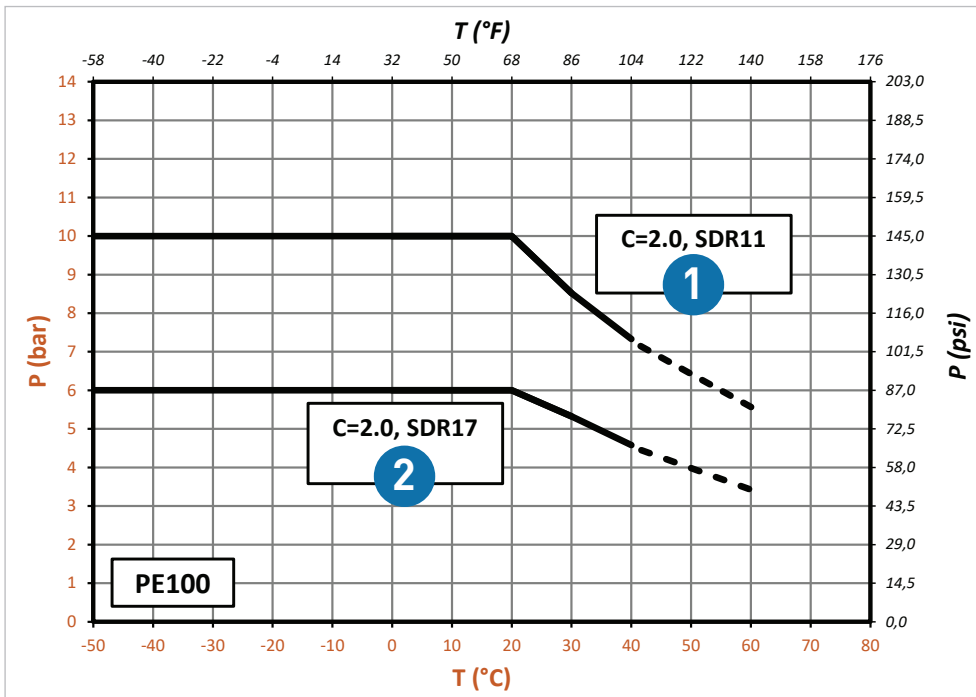

Pressure-temperature diagram for PE 100, gas

- 1** Design factor C = 2.0, S5, SDR11 for 20 °C Gas, 50 years
- 2** Design factor C = 2.0, SDR17 for 20 °C Gas, 50 years
- P** Permissible pressure (bar, psi)
- T** Temperature (°C, °F)

Gas curves limited to PN10 or PN6

2.3 Calculation of allowable pressure/required wall thickness

2.3.1 Selecting plastic piping components

Dimensioning of thermoplastic pipes subjected to internal pressure strictly adheres to strength requirements and is calculated using the vessel formula. All pipe dimensions listed in the standards are based on this formula. Deviations only occur in the lower range of diameters, since practical and manufacturing considerations make it necessary to maintain certain minimum pipe wall thicknesses.

$$e = \frac{p \cdot d}{20 \cdot \sigma_{zul} + p}$$

e Pipe wall thickness (mm)
 d Pipe outer diameter (mm)
 p Permissible working pressure (bar)
 σ_{perm} Permissible hoop stress (N/mm²)

Nominal pressure PN

The designation of "nominal pressure", PN (also known as pressure level), by itself is no longer sufficient. The PN classification generally used all over the world as information for pipe dimensioning is rather confusing where butt fusion is concerned.

In the case of plastic pipes and fittings, established practice is to use pressure-neutral descriptions for pipes and fittings of the same pressure capacity. This avoids incorrect use of pipes in different application areas or under different conditions.

ISO 4065 classifies pipes by series, whereby pipes with the same series number have the same load capacity, as is also the case in designations according to nominal pressure levels. The pipe series are denoted by the letter S. The series designation is based on the following formula:

S is a dimensionless value.

$$S = \frac{10 \cdot \sigma_{zul}}{p \cdot C} = \frac{d - e}{2 \cdot e}$$

e Pipe wall thickness (mm)
 d Pipe outer diameter (mm)
 p Working pressure (bar, psi)
 C Design factor

Hence, a PE pipe with measurements d110 and wall thickness = 10 mm results in:

$$S = \frac{(110 - 10)}{(2 \cdot 10)} = 5$$

The designation SDR (standard dimension ratio) is much more common on the market. SDR indicates the ratio of outside diameter to wall thickness.

$$SDR = \frac{d}{e}$$

The pipe series designation and the SDR designation are connected by this formula:

$$SDR = 2 \cdot S + 1$$

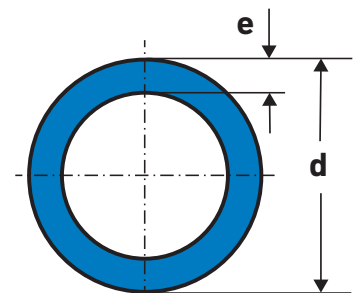

In the case of the example above, this results in:

$$\text{SDR} = 2 \cdot 5 + 1 = 11$$

The market primarily features the designations PN and SDR. GF Piping Systems recommends the use of dimension and wall thickness, as well as SDR at all times.

2.3.2 Calculating the effective design factor/permmissible working pressure

To calculate the design factor and allowable working pressure, it is necessary to know the long-term behavior of the material. This diagram allows the long-term creep strength to be read depending on the desired service life and maximum operating temperature. For fittings and valves, the wall thickness is usually greater than for pipes of the same pressure level. For this reason, the outside diameter and wall thickness of the pipe are used to calculate the design factor. The design factor is then calculated using the following formula:

$$C = \frac{\sigma_s \cdot 20 \cdot e}{p \cdot (d - e)}$$

- C Design factor
- σ_s Hoop stress (N/mm²)
- e Pipe wall thickness (mm)
- d Pipe outer diameter (mm)
- p Working pressure (bar)

Similarly, the maximum permmissible working pressure is calculated by modifying the previously mentioned formula in a similar manner:

$$p = \frac{20 \cdot e \cdot \frac{\sigma_s}{C}}{d - e}$$

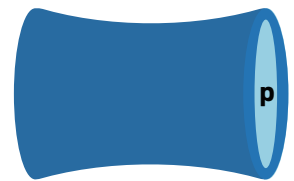
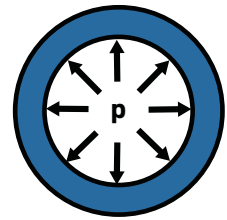

√ Example – Calculating the design factor and working pressure

Intended service life	50 years
Max. operating temperature	+ 20 °C
Max. working pressure of line	10 bar
Material	PE 100
Hoop stress	10.0 N/mm ²
Intended pressure level	PN16 bar
Outside diameter	d110
Wall thickness	10 mm

$$C = \frac{10 \cdot 20 \cdot 10}{10 \cdot (110 - 10)} = 2.0 > 1.25$$

For the sake of clarity, the calculation process will be shown using the previous example, but in this case, for the design factor the usual minimum value for PE 100 will be used.

$$p = \frac{20 \cdot 10 \cdot \left(\frac{10}{1.25} \right)}{(110 - 10)} = 16 \text{ bar}$$

! The calculation shown above applies only to freely moving pipelines. Pipes that are fixed in the axial direction (fixed installation) must be checked for buckling. In most cases such a check leads to a reduction of maximum inner pressure, as well as shorter distances between the support saddles. Furthermore, the forces acting on the fixed points must be taken into consideration. Contact your authorized GF Piping Systems representative for additional information.

2.4 Water hammer

Water hammer is a term used to describe dynamic surges caused by pressure changes in a piping system. They occur whenever there is a deviation from the steady state, e.g. when the flow rate is changed. The water hammers may be transient or oscillating.

Water hammers may be generated by the following:

- Opening or closing a valve
- Pump startup or shutdown
- Change in velocities of a pump or turbine
- Wave action in a feed tank
- Inclusions

⚠ Water hammers can quickly lead to an increase in pressure that exceeds the working pressure many times over!

The pressure wave created by water hammers causes the piping system to expand and contract. In the process, the propagation speed of the pressure wave is limited by the speed of sound in the corresponding medium. The energy carried by the wave is dissipated in the piping system and the waves are progressively damped, see the following figure:

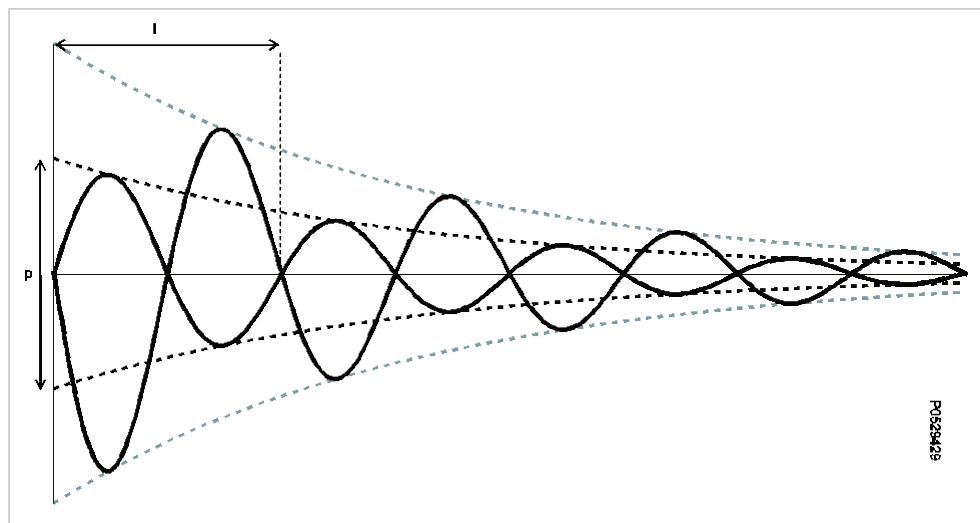

Damped pressure wave

l Wave length

p Pressure change

The maximum positive or negative addition of thrust is a function of flow rate, bulk modulus of elasticity of the fluid, the modulus of elasticity of the pipe material, and the pipe dimension. It can be calculated using the following steps.

[1] Determining the velocity of the pressure

$$V_w = \sqrt{\frac{K}{\rho \cdot \left(1 + \frac{K \cdot d_i}{e \cdot E}\right)}}$$

V_w	Pressure wave velocity (m/s)
K	Bulk modulus of elasticity of fluid (Pa)
ρ	Fluid density (kg/m ³)
E	Modulus of elasticity of pipe wall (Pa)
d_i	Inner diameter of pipe (mm)
e	Pipe wall thickness (mm)

The modulus of elasticity of pipes made of thermoplastic polymers varies with the operating duration and temperature. Hence, operating duration and temperature must be known for a precise calculation of water hammers.

[2] Calculating the maximum pressure change due to water hammers

$$\Delta p = V_w \cdot \Delta v \cdot \rho / 10\,000$$

Δp	Maximum change in pressure (bar)
V_w	Pressure wave velocity (m/s) (see step 1)
Δv	Change in flow velocity (m/s) = (v1-v2)
v_1	Velocity of fluid before change (m/s)
v_2	Velocity of fluid after change (m/s)
ρ	Density of liquid (kg/m ³)
	Conversion factor from N/m ² to bar is 1/100 000

All pressure increases induced by a flow reduction will have a corresponding pressure drop on the other side (vacuum). If this falls below the expected static minimum working pressure, the calculated pressure must be compared to the pressure at which the pipe collapses in order to evaluate the safety factor in step 4.

[3] Calculating the maximum and minimum total pressure

$$p_{\max} = p + \Delta p$$

$$p_{\min} = p - \Delta p$$

p_{\max}	Maximum total pressure (bar)
p_{\min}	Minimum total pressure (bar)
p	Expected working pressure (bar)
Δp	Pressure change caused by water hammer (calculated in step 2)

[4] Calculating the effective safety factor

$$C_{\max} = \frac{20 \cdot \sigma \cdot e}{p_{\max} \cdot (d - e)}$$

C_{\max}	Safety factor (dimensionless)
σ	Circumferential stress (N/mm ²)
d	Outside diameter of pipe (mm)
p_{\max}	Maximum operating pressure (bar) (calculated in step 3)
e	Wall thickness of pipe (mm)

The value for the circumferential stress can be found in the creep curves. As most water hammers last for a matter of seconds, the value for a load duration of 0.1 h can be used. An exception to this rule is the oscillating water hammers (e.g. caused by a displacement pump).

In this case the system must be treated as if a load equal to the maximum total pressure (p_{\max}) existed throughout the entire working life of the pipe.

[5] Safety factors

For infrequent water hammers, the common minimum values can be used as safety factors.
For periodic water hammers, the factor should be at least 3.

If the safety factor found in step 4 does not meet these criteria for safe operation, an increase in pipe diameter should be considered, or measures should be taken to reduce the occurrence of water hammers (e.g. powered valves, surge tanks, slow start-up pumps).

With use of powered valves, it is usual to have closure times greater than the critical period T_c to reduce water hammers. The critical period is the time a pressure wave needs to complete one cycle in the pipeline.

$$T_c = \frac{2 \cdot L}{V_w}$$

T_c Critical period (s)

L Pipe length (m)

V_w Pressure wave velocity (m/s) (see step 1)

Example



A water pipe from a storage tank is connected to a main valve that is hydraulically activated with an electrical remote control. The valve closing time is 1.5 s and the water flow rate is $Q = 35 \text{ m}^3/\text{h}$.

Material	PE 100
Outside diameter	d110
Wall thickness	10 mm
Nominal pressure	PN16
Pipe length	500 m
Operating temperature	20 °C
Short-term modulus of elasticity	$E = 1320 \text{ N/mm}^2 = 1320 \times 10^6 \text{ Pa}$ $\rho = 10^3 \text{ kg/m}^3$
Water density	$K = 2.05 \text{ GPa} = 2.05 \times 10^9 \text{ Pa}$
Bulk modulus of elasticity of water	

[1] Calculating the velocity of the pressure wave

$$V_w = \sqrt{\frac{K}{\rho \cdot \left(1 + \frac{K \cdot d_i}{e \cdot E}\right)}} = \sqrt{\frac{2.05 \cdot 10^9}{10^3 \cdot \left(1 + \frac{2.05 \cdot 10^9 \cdot 90}{10 \cdot 1320 \cdot 10^6}\right)}} = 370 \frac{\text{m}}{\text{s}}$$

[2] Calculating the fluid velocity before the change

$$v_1 = \frac{\text{Volume flow rate}}{\text{Cross sectional area}}$$

$$v_1 = \frac{35 / 3600 \text{ m}^3/\text{s}}{\pi \cdot (0.09 / 2)^2 \text{ m}^2} = 1.53 \text{ m/s}$$

Assume water velocity goes to zero after the valve is closed, i.e. $\Delta v = 1.53 \text{ m/s}$.

[3] Calculating the maximum pressure change due to water hammers

$$\Delta p = V_w \cdot \Delta v \cdot \rho / 100\,000 = 370 \cdot 1.53 \cdot 1000 / 100\,000 = 5.65 \text{ bar}$$

Δp is smaller than p . Hence, the minimum thrust does not have to be taken into account.

[4] Calculating the circumferential stress

The circumferential stress can be found using the long-term creep diagram for PE 100. The value for a load duration of 0.1 h can be applied as, for non-oscillating water hammers, the pipe needs to withstand this extra pressure for only a matter of seconds.

$$\sigma = 13.9 \text{ N/mm}^2$$

$$C_{\max} = \frac{20 \cdot \sigma \cdot e}{p \cdot (d - e)} = \frac{20 \cdot 13.9 \cdot 10}{21.65 \cdot (110 - 10)} = 1.28$$

[5] Calculating the maximum safety factor

The minimum safety factor for PE 100 can be set to 1.25 for water applications. Here, $C = 1.28 > 1.25$. The pipeline is also suitable for occasional water hammers. However it would not be suitable if periodic water hammers occurred, because in that case we would need a safety factor of at least 3. To meet these requirements, pipe dimensions or valve closing time would need to be adjusted so that water hammers are reduced.

Calculating the critical period

$$T_c = \frac{2 \cdot L}{V_w} = \frac{2 \cdot 500 \text{ m}}{370 \text{ m/s}} = 2.70 \text{ s}$$

In this example, the valve closing time is less than the value of the critical period. Increasing the closing time above this critical period would cause the water hammer to be reduced. The piping would then be suitable for all situations involving periodic water hammers.

2.5 Pipelines under vacuum

The mechanical load at absolute vacuum corresponds to a differential partial vacuum of 1 bar, i.e. the effective pressure on the pipe's inner wall is 1 bar less than the pressure on the outer wall at standard atmospheric pressure.

In case of a differential vacuum, special attention must be paid to the dimensional stability of the pipe. It can be calculated with the classic buckling formula for cylindrical pipes:

$$p_k = \frac{E_c}{4 \cdot (1 - \mu^2)} \cdot \left(\frac{e}{r}\right)^3$$

p_k Critical buckling pressure (N/mm²) (1 N/mm² = 10 bar)

E_c Long-term creep modulus (N/mm²)

μ Poisson's ratio

e Pipe wall thickness (mm)

r Mean pipe radius (mm)

A pipe at absolute vacuum (differential partial vacuum 1 bar) is adequately dimensioned against buckling when the critical buckling pressure $P_k = 2$ bar, i.e. when a minimum design factor of 2, is used for calculation. Any influence caused by out-of-roundness and eccentricity must be taken into account separately. Under these assumptions, the following maximum application temperatures arise for the various pipe materials (taking into account the general application temperature limits for the specific material). Very thin-walled pipe series are unsuitable for these conditions.

(25-year values: Poisson's ratio $\mu = 0.4$; design factor = 2)

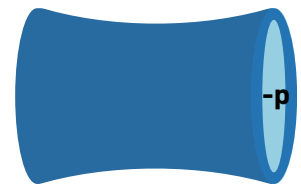
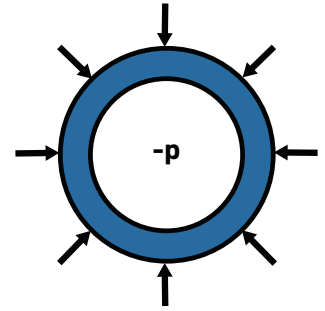

3 Hydraulic calculation and pressure losses

3.1 Hydraulic calculation

3.1.1 Required pipe diameter

Formulas

The following formula can be used for a first approximation of the pipe diameter required for a given flow rate:

$$d_i = 18.8 \cdot \sqrt{\frac{Q_1}{v}} \quad \text{or} \quad d_i = 35.7 \cdot \sqrt{\frac{Q_2}{v}}$$

v	Flow velocity (m/s)
d _i	Pipe inner diameter (mm)
Q ₁	Flow rate (m ³ /h)
Q ₂	Flow rate (l/s)
18.8	Conversion factor for units Q1 (m ³ /h)
35.7	Conversion factor for units Q2 (l/s)

The flow velocity must be approximated according to the intended use of the pipeline. Average values for the flow velocity are:

Liquids

- v = 0.5 – 1.0 m/s for the suction side
- v = 1.0 – 3.0 m/s for the pressure side

Gases

- v = 10 – 30 m/s

The pipe diameter determined in this way does not yet include the hydraulic losses. These have to be calculated separately. The following sections deal with this.

(m ³ /h)	(l/min)	(l/s)	(m ³ /s)
1.0	16.67	0.278	2.78 x 10 ⁻⁴
0.06	1.0	0.017	1.67 x 10 ⁻⁵
3.6	60	1.0	1.00 x 10 ⁻³
3600	60 000	1000	1.0

Conversion table with units for flow rate

√ Example for calculating the inner diameter d_i

PE 100 pipe	SDR11
Flow rate Q_2	8 l/s
Usual flow velocity v	1.5 m/s

$$d_i = 35.7 \cdot \sqrt{\frac{8}{1.5}} = 82.4 \text{ mm}$$

A pipe with DN80 (3 inches) is used. After definition of the inner diameter, the real flow velocity can be calculated with the following formula:

$$v = 354 \cdot \frac{Q_1}{d_i^2} = 1.9 \frac{\text{m}}{\text{s}} \quad v = 1275 \cdot \frac{Q_2}{d_i^2} = 1.9 \frac{\text{m}}{\text{s}}$$

v	Flow velocity (m/s)
d_i	Pipe inner diameter (mm)
Q_1	Flow rate (m ³ /h)
Q_2	Flow rate (l/s)
354	Conversion factor for units Q_1 (m ³ /h)
1275	Conversion factor for units Q_2 (l/s)

Correlation of outside diameter – inner diameter

To find the outside diameter using the inner diameter and the applicable SDR, use the following formula:

$$d = d_i \cdot \frac{\text{SDR}}{\text{SDR} - 2}$$

d_i (mm)	SDR11 d (mm)	d_i (mm)	SDR17/17.6 d (mm)
16	20	16	20
20	25	21	25
26	32	28	32
33	40	35	40
41	50	44	50
52	63	56	63
61	75	66	75
74	90	79	90
90	110	97	110
102	125	110	125
115	140	124	140
131	160	141	160
147	180	159	180
164	200	176	200
184	225	199	225
205	250	221	250
229	280	247	280
258	315	278	315
290	355	313	355
327	400	353	400
368	450	397	450
409	500	441	500
458	560	494	560
515	630	556	630
581	710	626	710
655	800	705	800

Correlation of outside diameter to inner diameter for SDR11 and SDR17/17.6

3.1.2 Nomogram for easy determination of diameter and pressure loss

The following nomogram simplifies the determination of the required diameter. In addition, the pressure loss of the pipes per meter pipe length can be deduced.

! The determined pressure loss from the nomogram applies only to a density of the flow medium of 1000 kg/m³, e.g. for water. Further pressure losses of fittings, valves, etc. have to be considered as shown in the following.

Using the nomogram

Based on the flow velocity of 1.5 m/s, a line is pulled through the desired flow rate (e.g. 30 m³/h) to the axis with an inner diameter of d_i (\approx 84 mm). A diameter close to that (74 mm for SDR11) is then selected and a second line drawn through the desired flow rate up to the pressure loss axis Δp (5 mbar per meter pipe). By following these steps, you can quickly determine the appropriate diameter and estimate the pressure loss for your specific application using the nomogram.

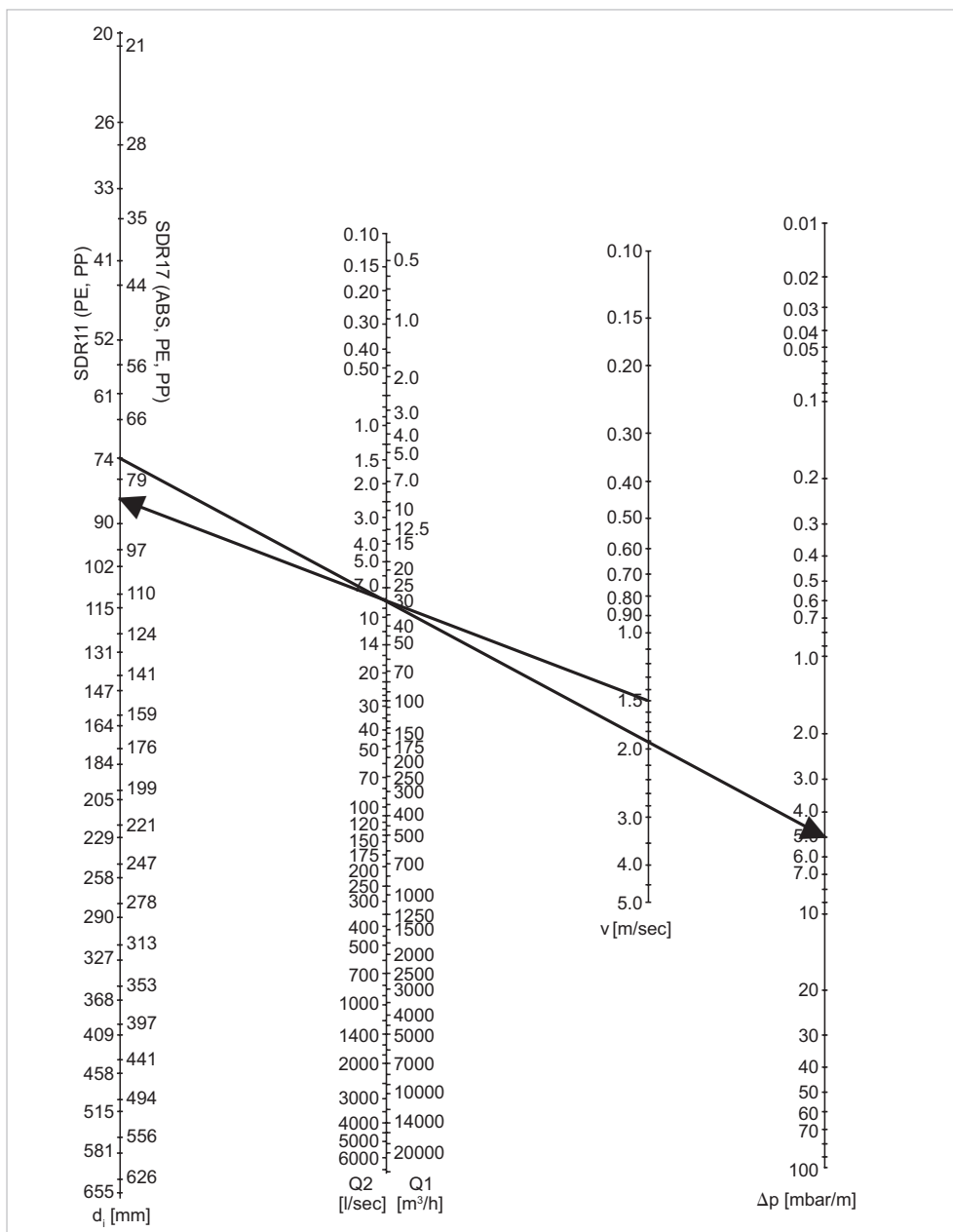

3.2 Diffusion

Gas losses caused by permeation are usually negligible for PE pipes and PE piping components, as they are very rare due to the relatively high wall thicknesses. As the PE pipelines for the gas supply are also exclusively connected by fusion jointing, no gas can escape at the joints. Conversely, permeations can also occur from the outside towards the inside.

$$V_{dG} = P \cdot \frac{\pi \cdot d \cdot L \cdot p \cdot t}{e}$$

V_{dG} Diffused natural gas volume (cm³) NTP
 P Permeation coefficient (cm³/m · bar · day) NTP
 Natural gas: $P_{PE100} = 0.056$ cm³/m · bar · day
 d Pipe outside diameter (mm)
 L Length of the pipeline (m)
 p Partial pressure of the gas in the pipe (bar)
 t Time (days)
 e Nominal wall thickness (mm)

NTP: Related to the normal temperature (23 °C) and normal pressure (1 bar).

Pipes with diffusion barrier layer

If, for example, water supply lines are laid through areas loaded with contaminants, depending on the type of contaminant, it is possible that they may diffuse through the pipe wall and permeate into the drinking water. To avoid impairment of the drinking water quality, PE pipes are offered with a diffusion barrier layer. For applications in contaminated soils, in zones with risk of flooding (sewerage) or in areas with increased risk of disaster (rail, chemicals), these offer a reliable and safe solution.

Layer structure of pipes with diffusion barrier:

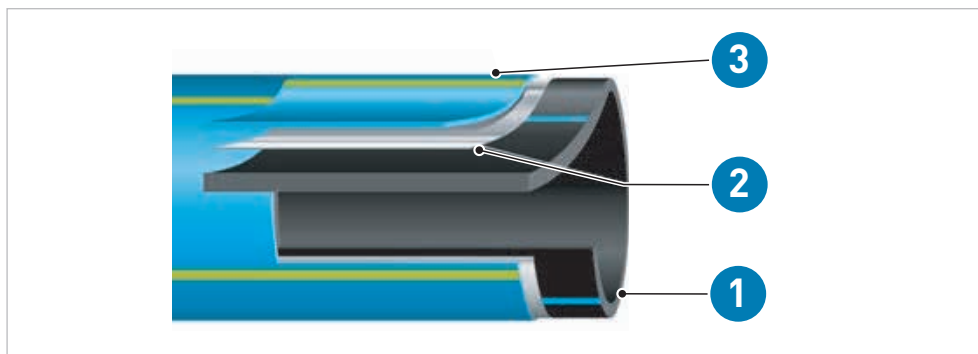

Layer buildup of pipes with diffusion barrier

- 1 Pressure-bearing PE media pipe
- 2 Additive, functional intermediate layer (aluminum foil)
- 3 Additive plastic outer layer

Fused connection points are subsequently sealed using a diffusion-tight film band.

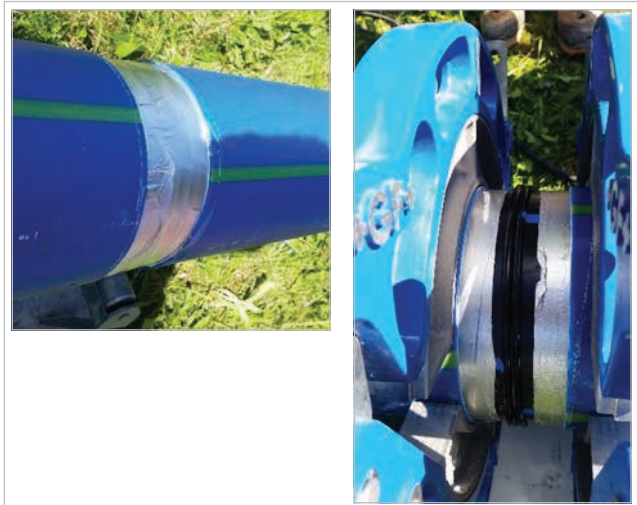

4 Laying

4.1 Health and safety at work

4.1.1 Risks when handling “thermoplastics”

Polyethylene (PE) as a semi-crystalline thermoplast:

- is odorless, tasteless, and physiologically harmless.
- does not excrete any hazardous vapors at usual fusion current temperatures.
- begins to melt at 125 – 140 °C.

⚠ Caution!

Skin burns: Fusion points can be as hot as 200 °C.

PE cleaners (for cleaning the fusion surfaces and heating elements):

- are usually based on ethyl alcohol or isopropanol.
- deplete the skin's natural oil barrier on contact.

⚠ Caution!

- Highly flammable
- Mucous membrane irritant (eyes, mouth, nose).

4.1.2 Combustion behavior

The material PE is classified as moderately combustible and weakly fuming. Building material class B2 in accordance with DIN 4102 or fire index according to SI/VKF: 4.3.

PE does not excrete any toxic gases when burning. Its effect is comparable with wood or wax.

- CO, CO₂, water vapor and hydrocarbons are produced during combustion, similarly to candle wax.

⚠ Caution!

- Do not inhale fumes.

- Continues to burn outside of the flame and drips off as it burns.

⚠ Caution!

- Can cause severe burns on skin.

- Can be extinguished using any commercial fire extinguisher.

4.1.3 Safety Rules on the Construction Site

It is essential to adhere to nationally and regionally applicable safety rules on the construction site. The following aspects should be observed:

- Personal protective equipment
- Safety documents for working in the pipe trench
- Safety documents for working on gas pipelines
- Safety rules for entering shafts, mines and passages

Safety plan/use zoning plan

In the safety plan, the planning engineer sets out which measures are used to counter potential hazards during construction and operation of the piping system. In addition to this, in the use zoning plan, he or she sets out which measures guarantee the usability of the piping system during construction and during operation.



Safety in the open pipe trench

The following list serves as a preparatory checklist for safety and efficient work in the open pipe trench:

- Are all the working area's service line plans available and are the service lines marked?
- For an excavation depth of more than 1.40m, are the trench walls sloped, shored or secured using other measures in accordance with the national regulations? (Trench access via ladders, etc.)
- Has the minimal trench width been adhered to?
- Are the employees in the trench and the surrounding work area protected with PPE (= Personal Protective Equipment)?
- Is personal safety ensured during the installation and disassembly of shoring?
- Is the stability of the trench also secured against the elements, etc.?
- Are people keeping clear of the danger area around machines, vehicles, devices and loads?
- Are exhaust emissions from combustion engines discharged from the trench?
- Is the personnel periodically informed about the specific dangers of trench and mine working and is adherence checked on site?

4.2 Construction site logistics and planning

Reliable construction site logistics are indispensable for cost and resource-efficient working.

4.2.1 Construction site setup and work ergonomics

Secure and reliable construction site conditions are not just sensible for the prevention of accidents, but create an efficient working environment and are the necessary basis for production of high-quality and durable pipe jointing.

The construction site must allow favorable conditions for the installation of piping systems:

- Suitable material storage for pipes, molded parts and all equipment, including the machines and tools not currently required in the trench: as close as possible to the later installation locations.
- Material storage on level and firm substrate enables simple arrangement and secure lifting/placement of the materials by the means of transportation. Access to the pipe storage must be guaranteed at all times.
- For larger sizes, suitable transport and handling options for installation must be available: Ensure professionally prepared use of hoisting belts and securing straps to avoid damage.
- Also note the remarks on safe storage and the risk-free transport of pipes and molded parts (see chapter „Storage“ on page 75).
- Avoid contamination of fusion and jointing faces due to the environment.
- Wear clean work clothing and eliminate all heavily soiled, oily or greasy items, or items which form oily or greasy mist, from the jointing environment.

All necessary piping components, hoisting and transport machines, fusion devices, generators, tools and aids must be available at the construction site on time and be ready for operation in a maintained state.

Detailed planning of the expedient sequence of various jointing technologies and the prefabrication of pipe modules enables cost-optimized project processing and also ensures a higher jointing quality.



4.2.2 Installation aids

Aids facilitate the laying and reduce the potential for risk during installation:

- For risk-free processing of coiled pipes, please observe the aids and information supplied (see chapter „Storage“ on page 75).
- For easy and precisely positioned movement of pipes, use height-adjustable roller blocks.
- The prefabrication of pipe modules should take place on a clean, dry and efficiently set up workspace close to the construction site. Be careful when lowering the bulky pipe modules into the trench!

4.3 Requirements for personnel, material and cleanliness

4.3.1 Personnel

Works on gas and water pipes may only be carried out by qualified personnel. In some countries, a national certification course is required for this. In any scenario, it is strongly recommended to receive product-specific induction from the manufacturer/supplier, particularly regarding laying and jointing technology..

4.3.2 Material

Before work begins, the pipes, moldings and valves must be checked in line with the technical specifications of the project's planning guidelines:

- Geometric suitability (d, SDR)
- Pressure level (NP)
- National approval and identification (material, color, intended use, production batch, etc.)
- Special requirements of the jointing technology (e.g. max. ovality of the pipes for electrofusion: <1.5% or max. 3 mm)
- Visual inspection for single-layer full-wall pipes: scratches up to a max. of 10% of the wall thickness permissible. No scratches, furrows, or flaking are allowed in the jointing/sealing area under any circumstances.

4.3.3 Cleanliness

The pipe network installer is responsible for ensuring that no soiling or contamination enters the piping system during the construction phase. As drinking water represents a foodstuff, it is subject to food laws. Hygiene is therefore important in drinking water lines, while for gas and water it is important to ensure that sensitive valves and instrumentation (e.g. gas or water meters) do not become damaged.

Pipes and fittings must be transported and stored so that they cannot be soiled by earth, slurry, dirty water, etc. We recommend sealing pipes with protection caps to prevent the ingress of dirt.

The open pipe end can be closed using a protection cap during short breaks in work. If a longer break in works is foreseeable, the open end of the pipe must be professionally closed for reasons of hygiene.

In order to meet the country-specific hygiene requirements, it is essential to use components (pipes, fittings, valves, gaskets, etc.) that are nationally approved.

4.4 Open pipe trench

The design of the pipe trench and the quality of the laying has a significant influence on the performance and the working life of pipelines, determining whether a pipe must withstand unacceptable subsidence or whether damage has already been recorded during the construction phase due to improper bedding.

Another significant part (~90%) of the costs for the new construction or renovation of a buried pipeline involving excavation work is the resurfacing. Efficient and professional laying and design of the pipe trench is therefore very cost-relevant.

4.4.1 Trench profile and pipe bedding

The relevant national and regional installation guidelines and regulations for buried pipelines apply for construction of the required pipe trench and for laying of the pipes. The pipe trench must be constructed such that all parts of the line can be laid at a frost-proof depth. The pipe coverage (coverage height) h is 0.6-1 m for gas and 1-1.8 m for water, pursuant to DVGW.

The trench base must be prepared so that the pipeline lies on it evenly. If the sub-surface is rocky or stony, the trench base must be dug out at a lower depth and the excavated material replaced by suitable ground material with a grain size that causes no damage to the pipes.

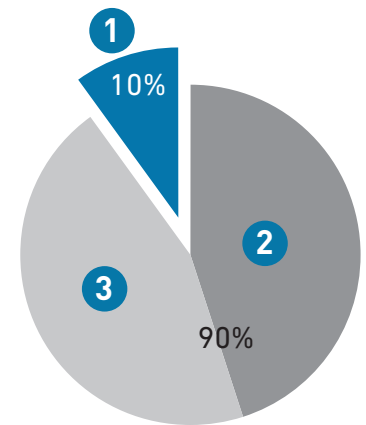

- 1 Pipe material
- 2 Deep mining costs
- 3 Resurfacing

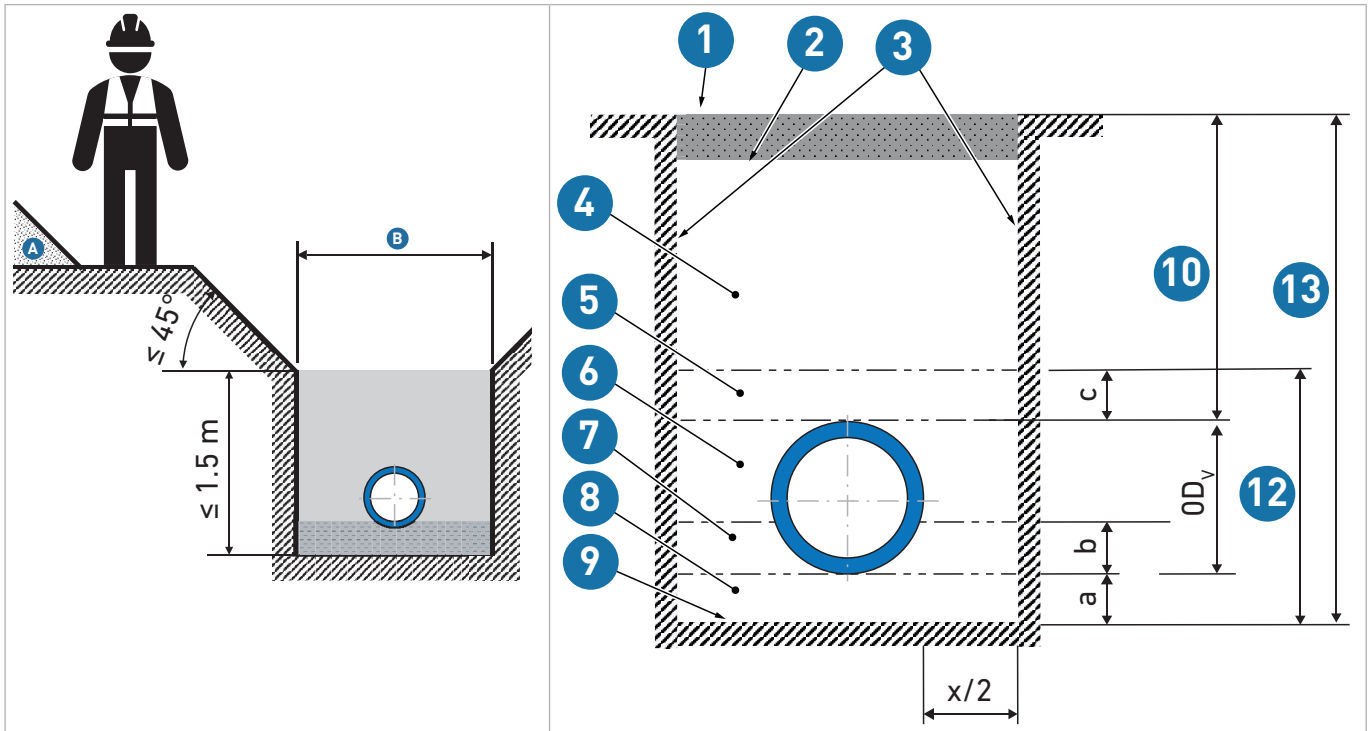

- A Excavation
- B Trench width

- with original excavation material
- (unbroken concrete gravel 0-16 mm or crushed sand <6 mm)

- 1 Surface
- 2 Lower edge of the road or sliding structure (if present)
- 3 Trench walls
- 4 Main backfilling
- 5 Cover
- 6 Side backfilling
- 7 Upper bedding layer (b)
- 8 Lower bedding layer (a)
- 9 Trench base
- 10 Coverage height
- 11 Bedding thickness
- 12 Pipeline zone thickness
- 13 Trench depth
- a Lower bedding layer thickness
- b Upper bedding layer thickness
- c Cover thickness
- ODv Vertical outside diameter

Perfect preparation of the pipeline zone is crucial for the load-carrying capacity of the PE pipes and fittings in the ground. The pipeline zone is the backfill in the region of the PE pipe and consists of the bedding, side fill and cover zone.

The pipeline zone must be created in accordance with the planning requirements and structural analysis calculation. The area between the trench base and side filling is termed "bedding". As a result of earth replacement, a load-bearing sub-surface must be ensured, i.e. for normal ground conditions, EN 1610 specifies a minimum thickness for the area of the lower bedding as $a = 100$ mm and for rocky or very hard ground as $a = 150$ mm. In addition to the minimum thickness, requirements are also set out regarding the building materials to be used for the bedding.

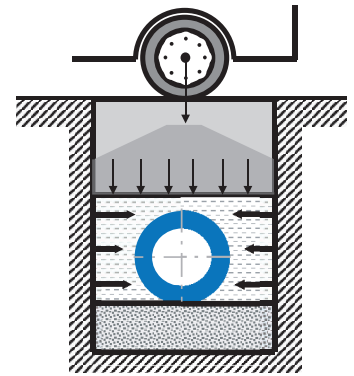

The area of the side filling and the coverage as well as the area of the hookups must be compacted in such a way that the pipeline does not become damaged or its position changed.

The pipeline must be evenly packed up underneath – particularly at the gusset areas (V) – using appropriate compacting devices designed for this purpose. Above the pipeline, the same approach should be applied for the height of the protective layer (HS).

- HS** The height of the protective layer 30-50 cm above the pipe (depending on the compacting machine)
- V** Pay special attention to the compaction of the gusset areas laterally under the pipe

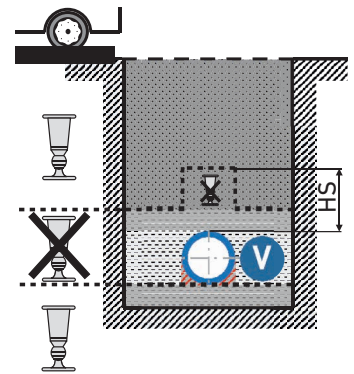

Pipelines in open trenches must lie flat. A part of the bedding must therefore be cleared in the trench base during laying, either underneath the connection points or in the area of the valves. Afterwards, special attention needs to be given to ensuring a proper seal and adjusting the sand bedding to fit the contour, especially for heavy components such as metal valves weighing over 90 kg with a DN of 200.

Remove temporary pipe supports and struts (timber beams) before the bedding! Compress the pipe bedding in layers and remove strutting.

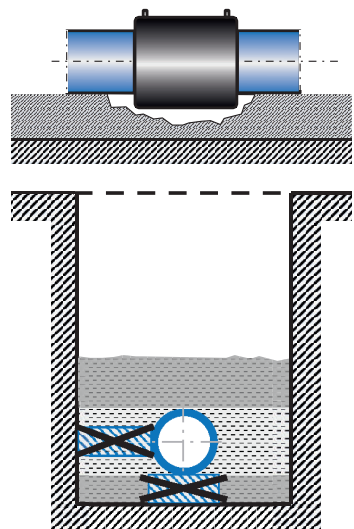

4.4.2 Trench shoring

The statutory stipulations, the policies of the national accident monitoring authority and the provisions of EN 1610 determine the requirements for the pipe trench.

- Trenches without shoring with vertical walls and firm bottoms may be a max. of 1.4 m in depth (EN 1610).
- Trenches with shoring with vertical walls/firm bottoms: struts up to ≤ 1.25 m above the base.
- For trenches without very firm bottoms, sloping trenches or stepped trenches should be created in accordance with EN 1610.
- The minimum working space $x/2$ in accordance with EN 1610 between pipe and trench wall or trench strut must be observed ($x/2 =$ at least 0.4 m).

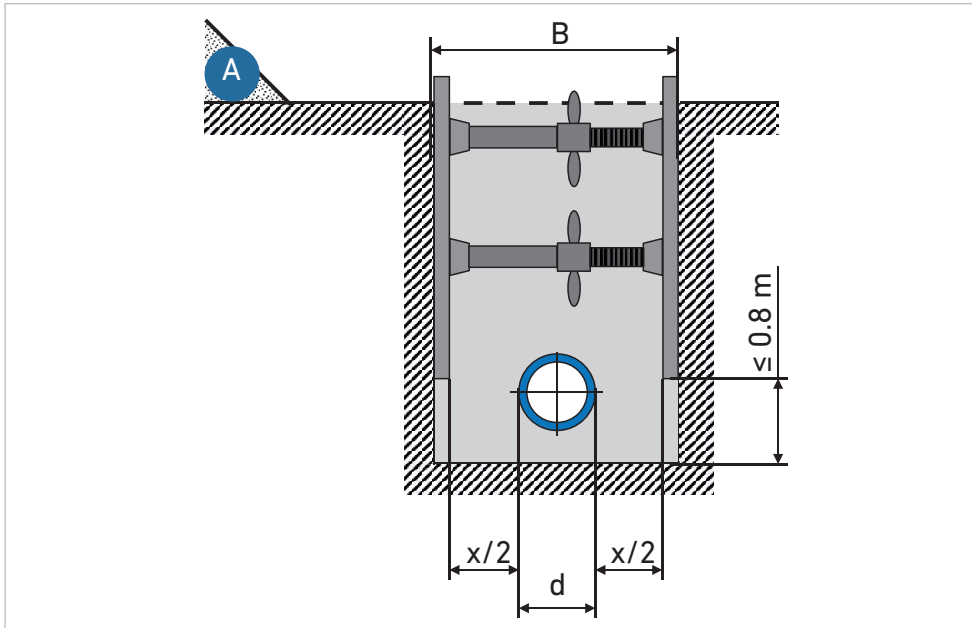

- B** Trench width
- A** Excavation
- d** Pipe outer diameter
- x/2** Half, side working space

4.5 Trenchless laying process

Trenchless laying allows costs to be saved compared to an open-trench design. Potential savings are generated by the reduction in construction time and the protection of resources, such as surfaces, backfill materials and storage space. Indirect costs can be reduced by avoiding adverse effects on residents and the infrastructure. A further advantage of trenchless laying is the reduction in dust, noise and CO₂ emissions thanks to less excavation work and fewer transport journeys. Safe laying is possible through use of PE pipes with protective and test properties.

However, not all processes are suitable for all types of base. Furthermore, not all pipe types are suitable for various processes of trenchless new installation and trenchless renovation.

4.5.1 Pipe types

The standardization (e.g. EN 1555) differentiates the different pipe types:

Type 1: Full wall pipe

Type 2: Full wall pipe with coextruded layers

Type 3: Full wall pipe with peelable layers

The crucial aspect is that the jointing technology, whether it's a jointing process or mechanical jointing, should always be performed at the specified nominal diameter "d". The coating must be removable before jointing using simple tools.

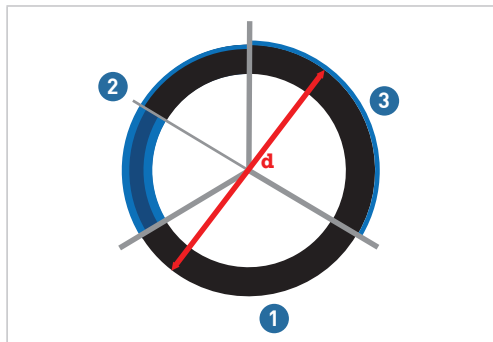

Schematic representation of various pipe types

- 1 Type 1
- 2 Type 2
- 3 Type 3

4.5.2 Horizontal directional drilling (HDD)

Horizontal directional drilling (HDD) involves the control of the bore-hole with the turning of an angled drill head in the drill hole. The subterranean cavity for the line in the ground is cut using a jet of water coming from the drill head. The drill head can be moved in all directions at any time. This has the advantage that it is possible not only to drill straight ahead, but also around existing obstacles

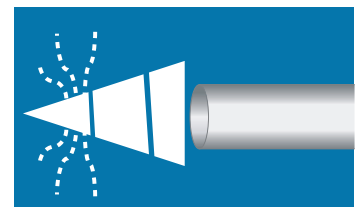

4.5.3 Plowing and milling process

Plowing process

The plowing process is preferred for the trenchless new installation in rural areas to lay large lengths of pipeline using few hookups. Non-self-driving systems consist of a laying plow with a plow strut, laying box and pipe bypass unit as well as a winch installed on a truck or crawler vehicle.

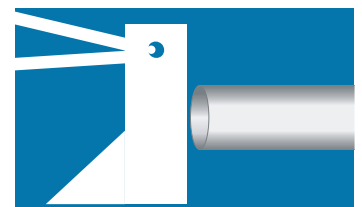

Milling process

The milling process is mainly used in rural areas for trenchless new installation. A motor-driven mill opens a narrow trench of up to 60 cm in width and a depth of up to 2.5 m. The pipe is inserted into this trench and the pipe trench ditch is backfilled virtually at the same time, generally directly using the excavation material.

4.5.4 Displacement hammer

The laying process of “soil compaction using a displacement hammer” is generally used for the trenchless new installation of house connections. A pneumatically driven hammer replaces the cavity for the newly inserted PE pipeline. The ground must be sufficiently displaceable for this. In loose and soft ground, static support of the displacement hammer is required, since it is not possible to build up adequate friction with the soil for independent propulsion. In stony ground, the propulsion channel can be formed more precisely with side displacement of the stones. The side breakout of the displacement hammer then occurs only occasionally. This process allows pipelines up to $d = 200$ mm to be laid.

4.5.5 Burst lining process

The burst lining process involves breaking up the old pipeline and pushing it into the surrounding soil. At the same time, a new polyethylene pipe of the same or larger nominal diameter is inserted. Depending on the applied force, a choice is made between dynamic and static burst lining.

In dynamic burst lining, a winch supports the burst and insertion procedure. A pneumatically driven burst hammer acts as the displacer. The driving energy is transferred to the old pipeline to break it up.

The static burst lining process is carried out using a hydraulic power source via a rod. The ladder-like connected rod pulls a burst body through the old pipe, destroys it and at the same time inserts the new pipe.

4.5.6 Relining process

Pipeline relining involves a flexible pipeline being inserted into the channel via excavation trenches. The pipeline made of new polyethylene pipes is either supplied in coils, or lengths which are jointed together on the construction site. Its length corresponds to the length of the section of pipeline to be renovated. The remaining annular space, a cavity between the new PE line and the existing old pipe/earth face, can be filled with hydraulically set insulators developed specially for this purpose. With backfilling of the annular space, this process improves the static load-bearing capacity of the pipeline section.

In pipeline relining without backfilling of the annular space, the annular gap between the existing old pipe and the new PE line does not need to be backfilled.

4.5.7 Close-fit lining

Close-fit lining involves minimal or no annular space. The material used could be a polyethylene pipe, for example, which can be distorted. In a warm state, the PE pipe is folded into a C/U shape. Once cooled, it is wrapped onto pipe drums and transported to the construction site. The cross-section of the pipe is reduced by the distortion by up to 30%, which facilitates insertion into the pipeline. After insertion into the old pipe, a new inliner pipe is warmed up with hot water vapor. The warmth triggers the memory effect, returning the PE pipe back to its original round shape. The inliner thus perfectly nestles up against the old pipe from the inside (close-fit) and permanently remains in this form. The close-fit process allows lines to be renovated. Close-fit differentiates further with the sub-processes of swagelining, rolldown, U-liner and compact pipe.

Contact your polyethylene pipe supplier or consult the national directives to select a suitable pipe for your preferred installation method.

When laying, ensure that the permissible tensile forces and bending radii are not exceeded.

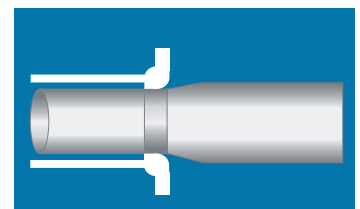
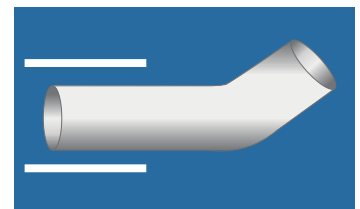
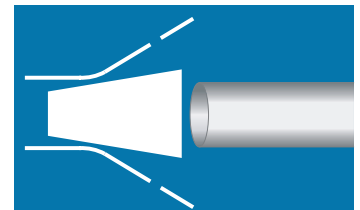
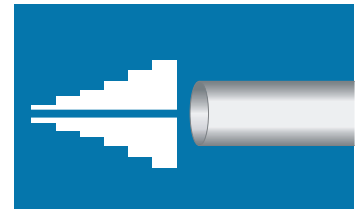
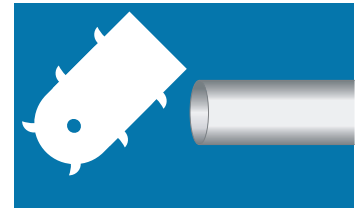

4.6 Processing and handling

Successful processing starts with the handling of the components. The aim here is to bring the components to the place of processing cleanly and without damage across the complete supply chain.

4.6.1 Oxide layer

In its melted state, the polymer is susceptible to oxidative reaction. During the extrusion process, the melt comes into contact with air and forms an oxide layer. This can adversely affect the connection quality and must be mechanically removed before fusion jointing (see chapter „Integral jointing technology (welding)“ on page 85).

In contrast, the fitting cools in the closed mold as part of the injection molding process, and there is therefore no oxidative reaction. This is true as long as the fitting is in its original packaging (bag and box).

Ultraviolet radiation also causes changes in the molecular structure on the PE surface. Longer storage or unshielded exposure to direct sunlight also causes an oxide layer to form, which restricts the connection mechanism for the fusion process. Hence, protection against direct sunlight is important to prevent the formation of an oxide layer on the surface of the components.

4.6.2 Packaging concept

For safe and reliable transport, the ELGEF Plus products are packed individually or in packaging units in a plastic bag and a box.

The boxes can be stacked and they protect the fitting from direct sunlight, dirt and damage. All ELGEF Plus electrofusion components are also individually packed in bags. Air circulation in the packaging is reduced to a minimum, which prevents a reactive environment from occurring. The packaging protects against dirt.

Injection-molded ELGEF Plus products are packed in bags and boxes directly after production. PE ball valves and spigot fittings in larger dimensions (>d315 and >d280 T90° reduced) are packed in boxes.

Seamless bends are made of PE pipe and packed on pallets without a box and plastic bag.

Materials used according to ruling 27/129/EG

Example symbol including use of the alphanumeric code:

Packaging	Alphanumeric code
Bag	PE-LD 4
Box	PAP 20
Wooden pallet/wooden crate	FOR 50
PP/PET tightening strap	PET 1/PP 5
Stretch film	PE-LD 4



4.6.3 Storage

Lengths of pipe

The pipe storage surface must be level and free of stones. Pipes must be layered and stacked in a way that avoids the risk of damage or permanent distortions. Larger-diameter pipes with lesser wall thickness must be fitted with stiffening rings. Avoid single-point or narrow longitudinal supports in pipes.

The max. stacking height of non-palletized stored PE pipes is 1 meter.

Pipe storage areas should be as well-protected as possible. Absorption of oil, solvents and other chemicals must be avoided at all costs during storage.

The impact of weather on the stored pipeline parts should be reduced to a minimum, i.e. they should be kept in a covered warehouse. If pipe storage is outdoors (e.g. on a construction site), they should be covered with sheeting for protection against the weather (e.g. UV radiation).

One-sided warming from exposure to the sun could cause distortions.

Pipes and parts should be used in the order of production/delivery, to ensure proper inventory turnover of the plastic material.

Fittings

ELGEF Plus fittings and PE ball valves must be protected against moisture and contamination throughout the entire duration of storage. The maximum recommended storage duration is ten years. In order to reach this maximum duration, the ELGEF Plus components must be stored in the original packaging (box + bag) at a temperature below +50 °C. The storage period starts with the date of production.

The PE bag film protects the ELGEF Plus fittings effectively against UV light. Storage without a box but in the undamaged bag is **possible for a maximum of up to two years**. During this time, the fittings can be welded safely. The processor is responsible for indicating the time that the fitting in the plastic bag was removed from the box.

Larger dimensions (>d315), which are usually also heavy and bulky, must be stored in the box in order to protect them against damage.

Seamless bends should be protected from direct sunlight. To avoid deformation, pallets with seamless bends must not be stacked.

ELGEF Plus fittings must not come into contact with solvents, greases, paints, silicone, or similar substances.

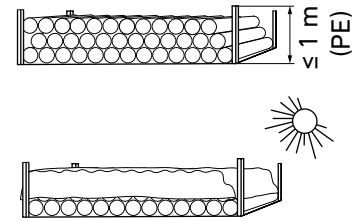

4.6.4 Transport and Handling

Pipes

Vehicles used to transport pipes must be capable of accommodating the full pipe length. The pipes must be supported to prevent them bending or deforming.

The area where pipes rest (including side supports) should be lined with padded sheeting or corrugated cardboard to avoid damage by protruding rivets or nails.

To prevent damage, pipes and fittings must not be pushed across the loading area of the transport vehicle, nor dragged along the ground to their place of storage.

Due care must be taken with loading and unloading. If lifting gear is used, this must be fitted with special pipe grips.

Throwing pipes and parts down from the cargo surface is not acceptable.

Impacts must be avoided at all cost. This applies especially at ambient temperatures below 0 °C where many plastics have significantly lower impact resistance (e.g. PVC).

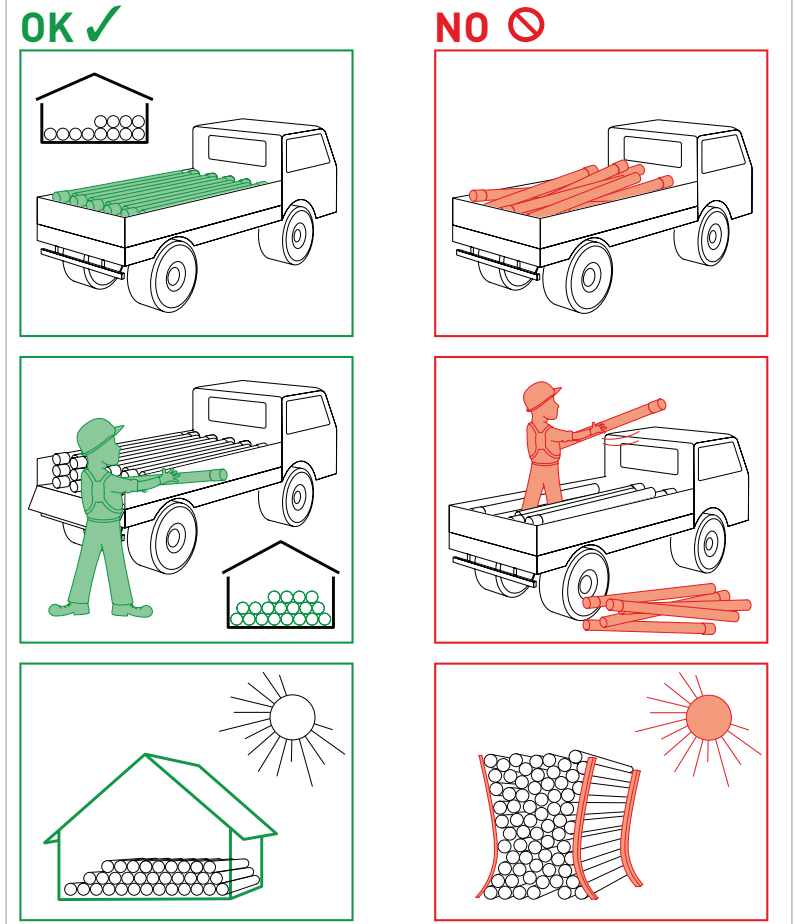

Coiled pipes

Coiled pipes have the advantage that long pipe sections can be laid without additional connection points. For this transported unit, however, the following particulars need to be noted during laying.

Coiled pipes have high interior stress and consequently makes them more challenging to install. Coiled pipes should therefore only be used in technically justified cases and in open pipe trenches > d110 mm.

⚠ Risk of accident!
 When uncoiling the pipe from the drum or ring coil, care should be taken when releasing the fixing to ensure the ends of the pipes do not spring out. It is important to act with caution as considerable forces are released, especially with larger pipes.

The pipes must be unwound straight and not kinked. Commercial unwinding equipment is therefore recommended for this.

During unwinding, it should also be noted that the flexibility of the PE pipes is influenced by the ambient temperature. For temperatures approaching freezing, still coiled pipes with an outside diameter of 75 mm and higher should be warmed if possible. This can be performed using steam or a pipe heater, for example.

Removing the pipe in a spiral manner is not permissible.

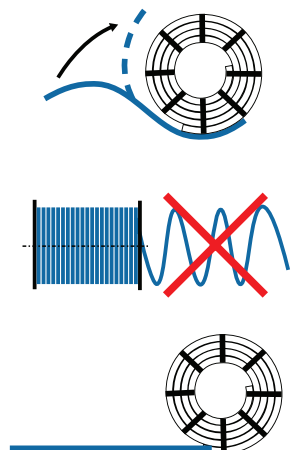

Fittings

To prevent transport damage, the fittings should be well protected during transportation. We recommend leaving the products in the original packaging until installation. If smaller quantities need to be removed, these should be transported in a box that protects them against ultraviolet radiation and contamination.

While unpacking, it is essential to handle the products with care, ensuring that the plastic bags remain undamaged and are not exposed to sharp or protruding edges, such as plug contacts.

Our recommendation is to unpack GF Piping Systems' fittings and valves right before their intended use.

To avoid damage, products should not be thrown.

Seamless bends should be transported on pallets.

4.6.5 Use of fittings on the construction site

To prevent the products from becoming contaminated and damaged, they should be removed from the packaging immediately before processing.

Cleaning the jointing surfaces is necessary in the following cases:

- The plastic bag is opened or damaged.
- The product is not packed in a plastic bag.
- The product was produced from a pipe, e.g. seamless or segment-fused bends.
- The jointing surface is soiled.

Peeling is necessary in the following cases:

- The product is not packed in a plastic bag.
- The product was produced from a pipe, e.g. seamless or segment-fused bends

4.6.6 Changes of direction

Changes of direction can be performed using the right fittings (bends, elbows).

It is also possible to produce segment-fused pipe bends from short pieces of pipe. For this, however, in line with EN 12201-3, a weakening factor of 0.8 needs to be taken account of for a 15° fitting (2 x 7.5° angle of cutting on the pipe)! Angle of cutting >15° is not permissible.

Tees made of fused pipe sections, meanwhile, have a weakening factor of ≤ 0.6 .

By using the high elasticity of PE, long lengths of pipe can be bent in situ at the construction site without warming. To ensure that no damage is caused by kinking of pipes during laying, the pipes must not be warmed using hot air or similar, and the values for the smallest permissible bending radius must not fall below the specified values.

The acceptable bending radii at varying temperatures are a multiple of the pipe's outer diameter*:

Permissible bending radii

Pipe wall temperature	20 °C	10 °C	0 °C
SDR level	Minimum bending radius for PE		
SDR 7.4 – 17	20 x d	35 x d	50 x d
SDR 26	30 x d	52.5 x d	75 x d
SDR 33	40 x d	70 x d	100 x d

For laying, e.g. for pipe insertion during trenchless laying, with PE pipes SDR 11 and 17 in a depressurized state (20 °C), a minimum bending radius of 10d may be used for a short time**.



* Source: DVGW worksheet GW 321 (Table A.3). Values between the temperatures can be interpolated linearly

** Source: DVGW worksheet GW320-1 (Appendix A)

4.7 Internal pressure and leak test

The leak test is conducted to ensure the integrity of completed pipeline sections.

Depending on the application area of the pipeline, various basic norms apply for the leak test.

- Industrial pipelines laid above ground, for example, are checked according to DVS 2210. More details on this can be found in the “**Planning fundamentals for industry**” provided by GF Piping Systems.
- Buried pressure pipelines in the water and gas supply, on the other hand, are checked in accordance with EN 805 or DVGW W400-2 (water), for example, or DVGW G469 (gas).

The following models relate to the pressure test for buried pressure pipelines in the water supply based on EN 805 (Water supply – requirements for water supply systems and their components outside of buildings) or DVGW W 400-2 (Technical rules for water distribution plants – Part 2: Construction and testing).

4.7.1 The purpose of a pressure test is:

Pressurising a pipeline before commissioning serves the following purposes:

- Ensuring the piping system’s resistance to pressure
- Showing the leak-tightness against the test medium

The pressure test uncovers only rough processing or laying faults:

- Non-fused electro-fusion connections or contaminants in butt fusion (grasses, paper)
- Missing gaskets or untightened mechanical jointing
- Damage by third parties (excavator intrusion)

The pressure test does not supply information about the quality of jointing. The jointing quality can only be guaranteed by professional installation.

4.7.2 Test methods and processes

In general, the following three methods are used for pressure tests on buried pressure pipelines

- Pressure loss method
- Water loss method
- Visual inspection under working pressure

To test newly installed pipelines, the pressure loss method has gained popularity in practice because it is less sensitive to the presence of inclusions, offering greater reliability.

Various test methods for pressure tests are used depending on national and international standards and guidelines as well as local conditions. They vary in the test process, test time and test pressure. Buried pipelines made of plastic are usually checked using the contraction process or the normal process. The more time-consuming normal process is predominantly used for longer test sections and larger nominal diameters (>d400 mm) with larger line volumes (>20 m³).

4.7.3 Safety and trench backfilling

Safety at work

Pressure tests must be performed by qualified personnel with the appropriate knowledge of pipeline technology, performance of pressure tests, measurement technology and safety guidelines. In addition to general safety guidelines, the following points should be observed:



Caution!

- Limit activities within the pipe trench to those directly related to the pressure test.
- The start and duration of the testing must be communicated to the people involved in the construction.
- While pressure is being built up, it is crucial that no individuals are present in the pipe trench.
- Throughout the pressure test, it is important to ensure that no one could be positioned in the path of any potentially airborne components, which means staying clear of the area to the side of the pipe axis.

Trench backfilling

Before pressure testing, pipelines are to be covered with filling material so that changes to position are avoided and the influence of temperature is kept as low as possible. Filling in the area of jointing is exempted.

4.7.4 Filling the pipeline

The pipeline should be filled from the geodetic lowest point. Special attention should be given to the air vent. If possible, vents should be provided at all the high points of the pipeline and these should be open during filling of the system.

Flushing velocity should be at least 1 m/s.

Adequate time should be allowed between filling and testing the pipeline, so that the air contained in the piping system can escape via the vents: approx. 6 – 12 h, depending on the nominal diameter.

4.7.5 Test pressure

Determining the system test pressure (STP)

The pressure test – with the exception of the visual inspection – should generally be performed with a higher pressure than the highest working system pressure (MDP). In water supply networks, it is advisable that the maximum working system pressure (MDP) not fall below 10 bar. For all pipelines, the system test pressure (STP) should be determined based on the working system pressure (MDP). In the case of an uncalculated water hammer (most common case), the following calculation applies with an assumed working system pressure (MDP_a):

$$\text{STP} = \text{MDP}_a + 5.0 \text{ bar} \quad \text{and} \quad \text{STP} = 1.5 \cdot \text{MDP}_a$$

The smallest value should always be taken.

Due to the breaking points of the pipe material, the following maximum test pressures should be noted:

- PE 100 SDR17: STP_{20°C} ≤ 12 bar
- PE 100 SDR11: STP_{20°C} ≤ 21 bar



Caution!

Pressure tests should not be performed if the pipe wall temperature exceeds 20 °C, as the high load will result in material damage which can severely reduce the service life! Please follow the instructions in the operating manual to accurately determine the required cooling times after jointing.



The pressure test is performed with opened valves.

4.7.6 Contraction process

The contraction process is performed in two stages with a pretest (breaking point test) and a main test (leak test), either using the water loss or pressure loss method, depending on the equipment technology.

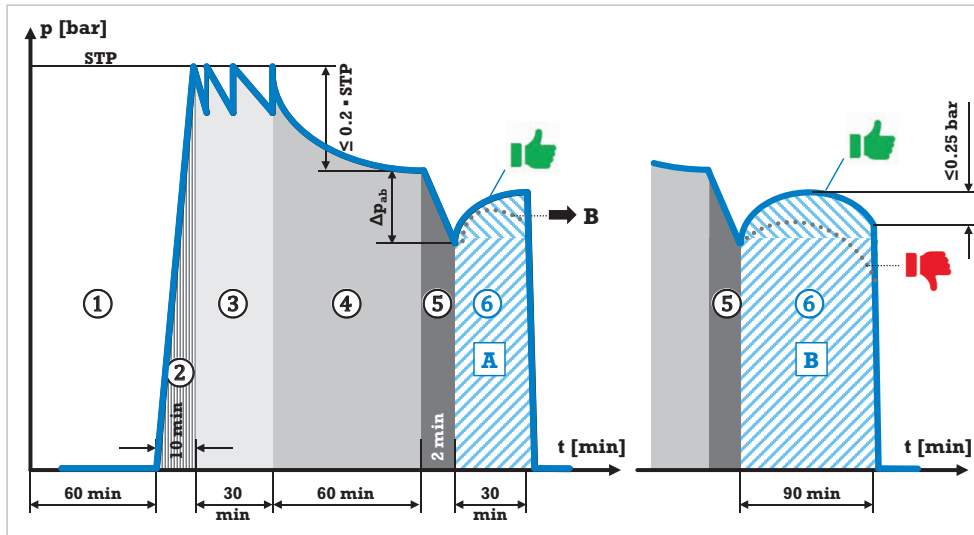
The system has passed the test if both the conditions of the pressure drop test and the condition of the subsequent leak test have been met in the main test. The test parameters (duration of test, pressure drop, permitted water loss quantity, permitted pressure drop) should be taken from the national standards and guidelines.



- A Initial inspection
 - B Extension (90 min)
 - 1 Preparation phase
 - 2 Pressure buildup
 - 3 Pressure holding phase
 - 4 Rest phase
 - 5 Pressure reduction
 - 6 Main test
-  Leakproof
 Not leakproof

4.7.7 Visual inspection

A visual inspection under working pressure is frequently performed:

- for repair work,
- for new pipe sections up to 30 m in length, and
- for hookups to existing lines ($d \leq 63$ mm).

Here, the tightness, in particular at the non-filled connection points, should be determined with two inspections one hour apart.

4.8 Installation

4.8.1 Cleaning/rinsing

During the construction phase, all contamination of the pipeline should be avoided as much as possible to reduce the high costs of subsequent cleaning, rinsing and disinfecting. The measures for this are:

- Leak-proof closure of the pipeline during breaks in work
- Pipe inspection and, if necessary, cleaning before laying
- Sealing the pipe with protective caps until just before installation is essential.

Despite adhering to the measures mentioned earlier, surface water, sand, or other impurities might still find their way into the pipeline. In such cases, it's necessary to perform a thorough cleaning and rinsing of the pipeline before it can be put into service.

The pipeline must be cleaned in the area of soiling (manually or pigging), and should be rinsed with drinking water as soon as possible after completion of the piping system construction (with three to five times the pipe's capacity and with 1.5 – 2 m/s flow velocity).

In the case of distribution pipelines, the introduction of the rinsing water should generally be carried out via the existing distribution network (e.g. from hydrants), and expulsion via the sewerage system (to be coordinated with the waste water system operator).

If, during the rinsing of a pipe section, only a minimal flow velocity is achievable, the rinse action can be improved either with alternate rinsing/interrupting or with introduction of oil-free compressed air. A rinse duration should not drop below 15 s per running meter of pipeline.

Hygiene inspection

After rinsing or after disinfection of the pipeline, water samples should be taken for microbiological analysis. Often, the drinking water line may only be approved once the hygiene analysis results have proven its microbiological harmlessness.

4.8.2 Disinfection of piping systems

If there is a negative finding, the pipeline section must be disinfected (to be performed in accordance with DVGW W291 A). To disinfect the pipeline, for larger diameters the standard process is used, leaving the disinfection solution to act for 12 to 24 hours during the leak test or, for smaller diameters, the flow process is used in which rinsing and disinfection take place at the same time. For both processes, attention must be paid to the precise adherence to the dosing of disinfectant (sodium hypochlorite, chlorine gas, hydrogen peroxide) and service life/flow velocities so that neither the pipeline nor the jointing elements such as gaskets become damaged.

The disinfecting of PE pipelines with chlorine dioxide (as is usual with cast iron pipes covered in cement mortar), is only recommended if the precise dosing/action time and temperature is very strictly adhered to. An overly high concentration can not only damage the PE piping system but may also be harmful to the human body. The used disinfection solution must be neutralized before introduction into the surface water and the introduction conditions according to the Water Protection Ordinance must be complied with. Particular attention should be paid to occupational health and safety in the handling of the disinfectant chemicals. After disinfection, the pipeline should be rinsed again using 3-5 times the pipe capacity.

4.8.3 Cleaning, drying (gas)

Contaminants (sand, chips) in the pipeline must be removed and contamination cleaned, as even small particles can impair the function of sensitive valves (gas meters, nozzles). If a leak test of the line has been carried out using water, the pipeline may need to be blow-dried (pigging followed by clean, oil-free compressed air).

4.9 Repairs during operation

For repairs to polyethylene pipelines, the following moldings and jointing technology are available:

- Electrofusion (collar as repair piece or repair saddle)
- Compression joint (coupling or saddle)
- Push-fit (collar as repair piece)
- Pipe couplings as sealing clamps (for PE, to be used as a temporary emergency solution only!)

For fusion jointing of water supply lines, the jointing point must be dry.



Caution!

Joining gas supply lines when there is a gas leak is prohibited due to the risk of explosion. Working on gas lines under pressure is hazardous in general! Please heed the national stipulations for working with gas lines (e.g. DGUV BG 500 Chapter 2.31 Working on gas lines).

4.9.1 Shut off flow of media

For both gas and water lines alike, the rule applies that the flow of media must be shut off before repair. There are various options available for this

- Closing fittings (gate valve, ball valve, pressure tapping valve)
- Setting an isolating bladder (to be used with gas, not with water for reasons of hygiene)
- Squeezing off

Gas

- The greatest care should be taken when working on gas lines under pressure (strict adherence to national policy).
- Close to repair points, assemble temporary shut-off devices in all gas-bearing lines.
- Temporary shut-off device = set isolating bladder.
- Gas pressure ≤ 50 mbar (for manual bladder).
- Install gas shut-off bladder against the flow using stop off saddles and bladder removal tools (manual bladder only in an emergency!).

Water

- Avoid creating pressure before the bladder, as it may cause the bladder to be pushed into the pipe.
- The bladder is inserted with the flow (reverse direction to the gas) and a defined outflow must be made possible via the stop off saddle to relieve the pressure in front of the bladder!
- In drinking water systems, the isolating bladder must meet the hygiene requirements (clean, free of germs and oil, etc.)

Squeezing off

The flexibility of PE permits the squeezing off of the pipe to shut off the flow of media. However, the following must be observed (DVGW GW 332):

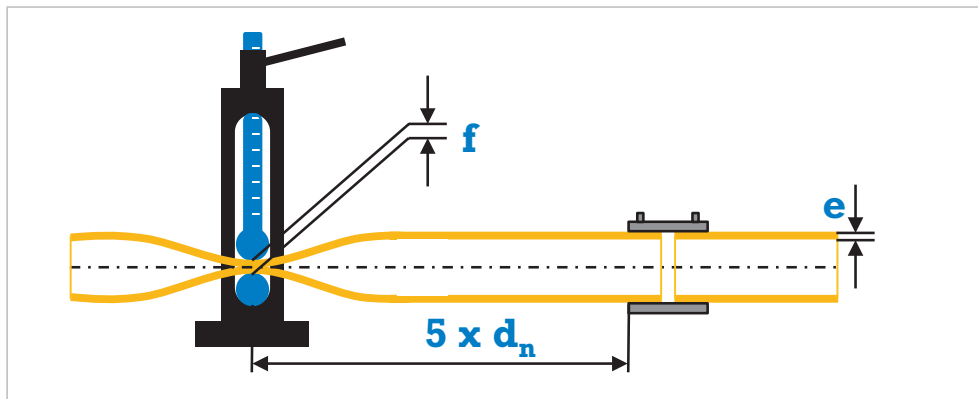

$$f \geq 0.8 \cdot 2 \cdot e$$

f Squeezing off level

- Squeezing off should only be used as an emergency measure when there is damage.
- Distance to jointing points of $> 5 \times d_n$ to be observed.
- Reduce the line pressure as much as possible before squeezing off.
- A 100% leak-free state can often not be achieved in practice after one squeezing off. For gas and for higher pressure, double squeezing off with intermediate venting (gas) or intermediate emptying (water) is recommended.
- Only one squeezing off at each point. To avoid this, the geodetic position must be documented in the works plan/network land register or in the GIS. In addition, the squeeze point must be permanently marked (warning sticker) or an electrofusion saddle must be fused on in the immediate vicinity ($< 5d_n$).
- Slowly squeeze the pipe and gradually reform its shape (specially in cold ambient temperatures).
- Use suitable, standard market squeeze off tools with the correct spacers (nominal diameters and SDR level), so that the squeeze off level can be adhered to.
- At high pressure: double squeezing off with intermediate venting (gas) or intermediate emptying (water).

- Squeezing off for diameter $dn \geq 160\text{mm}$ or wall thicknesses $e \geq 10\text{mm}$ is not recommended.
- An undefined squeezing off until a leak-proof state is reached is not permissible! The squeezing off level should therefore not fall below 0.8, because otherwise this will result in material damage at the squeezing off points.

Pipe sleeves

Water flowing in (e.g. through leaking gate valves) is damaging during jointing. For this purpose, pipe sleeves offer a retention option with no technical faults. Damming up with sand or similar is not permissible due to drinking water hygiene!

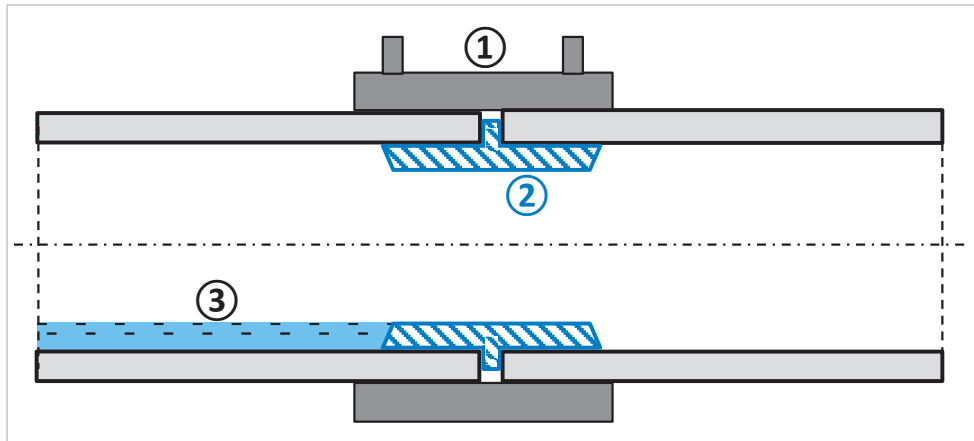

- 1 Electrofusion coupler
- 2 Pipe sleeve
- 3 Backed-up residual water

Minor damages

In the case of minor damages (pinhole; short, but deep crevices/scratches) the defective point can be repaired with a closed spigot or tapping saddle.

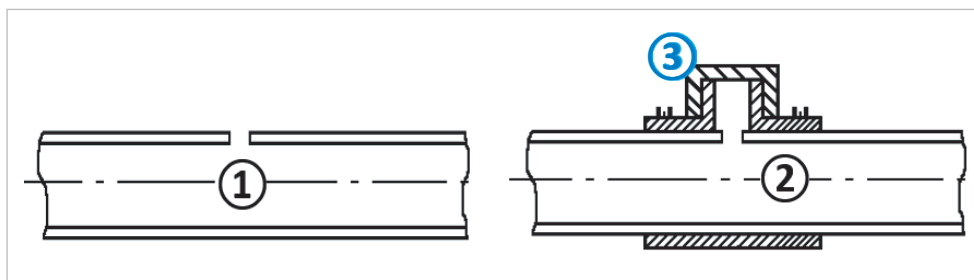

- 1 Defective pipe piece
- 2 Repair saddle
- 3 Cap

Reducing cracked notches

It makes sense to first reduce the effect of the notch at the crevice ends of the defective area by drilling out.

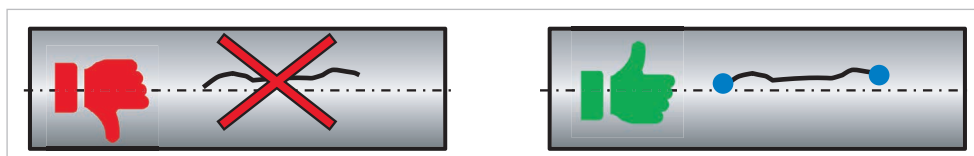

4.9.2 Major damages

If there are significant damages, such as those caused by an excavator, it is recommended to remove the damaged section of the pipe and replace it with a new piece using 'hoses'.

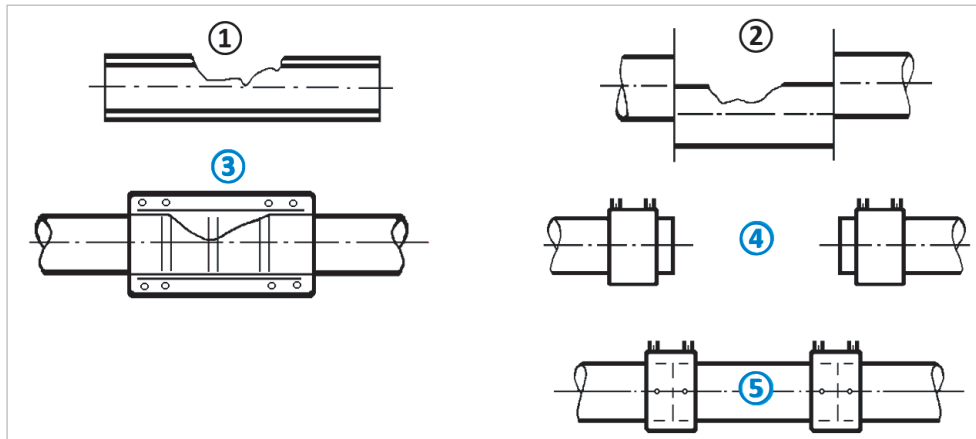

- 1 Defective PE pipe
- 2 Cut out pipe piece
- 3 Pipe coupling (although sealing clamp for PE recommended as a temporary solution only!)
- 4 ELGEF Plus couplers slid over
- 5 Repaired PE pipe



5 Integral jointing technology (welding)

5.1 Integral connections

To retain the greatest possible benefit from pliable, subterranean PE piping systems, homogeneous integral jointing technology should be chosen. The integral jointing connections offer ideal mechanical prerequisites for a long service life, exhibit the lowest frequency of damage and provide the best hygienic conditions for the transportation of drinking water or gas.

A further significant advantage of jointing is the option to have seamless quality assurance, whereby all components as well as the jointing technology can be automatically documented with a traceability system.

From the wide range of solutions offered by GF Piping Systems for the purpose of integral connections, the methods commonly used in underground piping system construction are described in more detail below:

Connection type	Butt fusion	Electrofusion
Dimension range	d40 – d1200	d20 – d2000
		

5.2 Butt fusion heating element

5.2.1 Overview

Material: PE

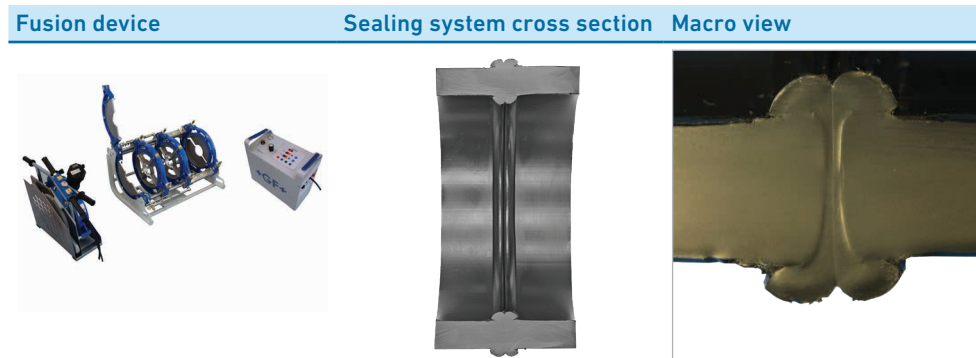

For heating element butt fusion (HS), the welding zones of the parts to be joined such as pipes, fittings, or valves, are heated to the fusion temperature and mechanically pressed together without the use of additional materials. This results in a homogeneous joint. Butt fusion joints for pressure pipelines must only be created with a fusion device that allows the jointing pressure to be regulated. For construction of pressure pipelines, the components to be jointed must have the same wall thicknesses.

Principle of heating element butt fusion

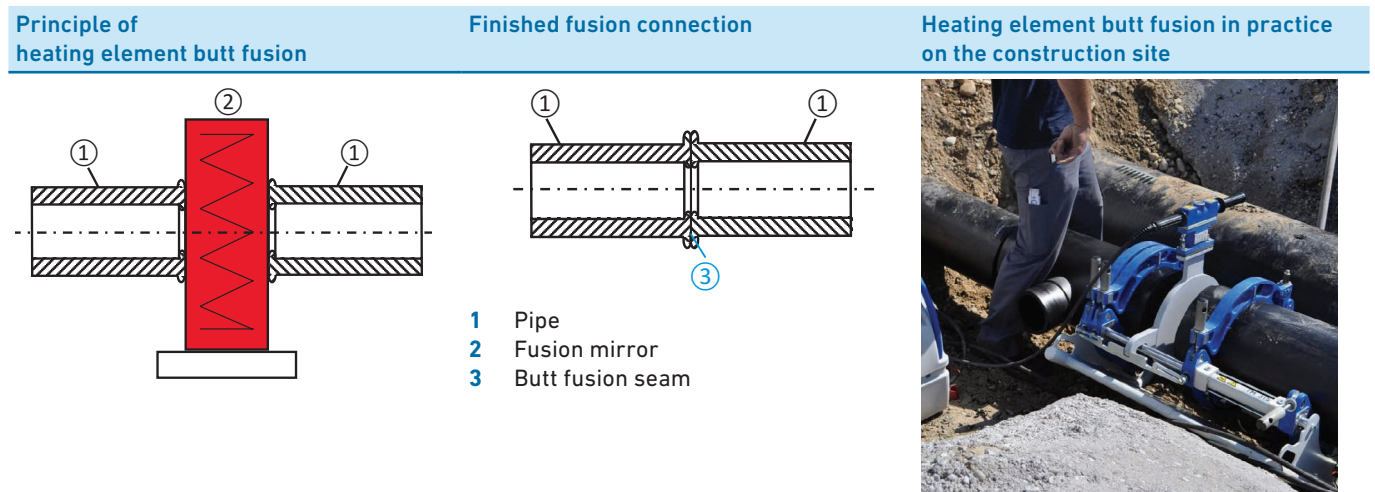

Advantages and properties

Heating element butt fusion joints are cost-effective connections that can be made on corresponding fusion jointing machines up to large diameters (2000 mm and more). Professionally prepared butt fusions meet the same requirements as the components.

A wide range of machines is available for heating element butt fusion; these are designed for workshops, pipe trenches or fitting fusion and can be operated manually, electrically or hydraulically.

On specially equipped workshop butt fusion machines, it is also possible to fuse pipe sections at an angle, allowing the creation of segment-fused bends or T-pieces.

In this case, it is important to observe that, the nominal pressure of these fittings is reduced compared with the output pipe in accordance with EN 12201-3:

- Bends with $\geq 15^\circ$ fitting ($2 \times 7.5^\circ$ angle of cutting on the pipe) exhibit a weakening factor of 0.8.
- Tees made of fused pipe sections, meanwhile, have a weakening factor of ≤ 0.6 .
- Cutting angle of the segments at $>15^\circ$ is not permissible.

i For additional information about using the fusion procedure for corresponding materials, see www.gfps.com.

5.2.2 Installation process

The following installation process is representative for all GF butt fusion machines. For detailed and specified machine handling, please see the relevant operating manual.

For more detailed information, please see our website www.gfps.com or contact your regional GF Piping Systems sales office.

Prerequisites

Only materials of the same kind may be fused with each other (PE to PE). For butt fusions, only pipe ends with the same wall thickness (SDR class/pipe series) can be connected to each other to maintain the maximum permissible wall thickness misalignment of 10 % ($\Delta s \text{ max.} = 0.1 \times s$). The butt fusion of SDR17 with SDR17.6 components is therefore permissible.

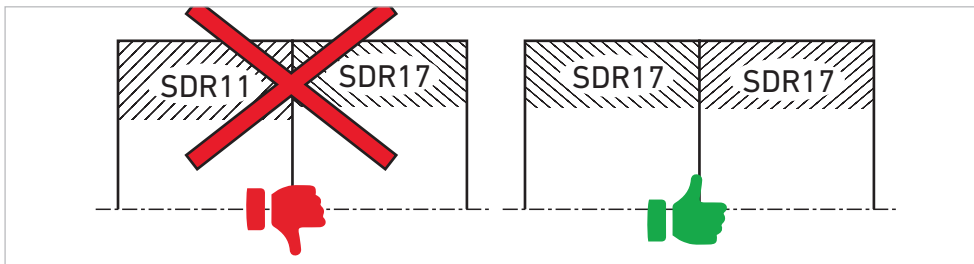

Make sure you have sufficient space in the welding zone and the working environment permits professional work.

[1] Cleaning the heating element and joint surfaces

→ Prior to each welding operation, ensure the heating element is cleaned using dry, clean, and lint-free paper.

- Before heating, clean with paper towels and PE cleaner
- In a warm state, clean with dry paper towels

Caution – danger of burning!

→ Before cutting work is carried out on the joint surfaces, ensure that the tools used and the workpieces across and beyond the welding zone are clean and free of grease; if necessary, clean using a cleaning agent.

Preparation of the connecting surfaces must take place immediately before jointing begins.

[2] Aligning and clamping pipes

To minimize the displacement caused by pipe ovality, the pipes must be aligned in accordance with their signatures as much as possible.

Clamp pipes/fittings securely. Clamp with two jaws on both the fixed and the movable side of the fusion machine.

Safely position and support the pipe ends on roller blocks. This makes it easier to ensure flush alignment and secure clamping.

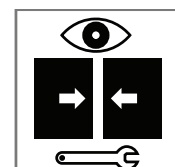
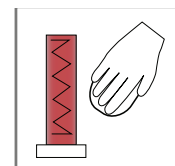

[3] Planing

Check whether the planer is clean and free of grease on both sides!

Commence planing only immediately before the welding process begins.

Plane jointing ends flat; even, uninterrupted machining at least **1 to 1.5 × circumference**.

Pay attention to good removal of chips.

Stop planing intermittently. Remove chips and check result of planing.

Check: same wall thickness of welding ends.

Remarks: When planing the ends of the fittings (e.g. reductions, end caps, bends), changes in pipe wall thicknesses may occur depending on the construction. This should be rechecked. The nominal wall thicknesses of the parts to be jointed must match the joint area.

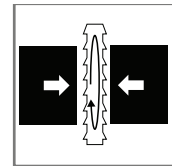

[4] Offset and gap check

The offset must be checked at the same time as the gap width is checked.

The offset of the joint surfaces to one another must not exceed the permissible distance of $0.1 \times$ wall thickness on the outside of the pipe.

Offset check: Maximum permitted offset $\leq 10\%$ of wall thickness

$\Delta s \text{ max.} = 0.1 \times s$

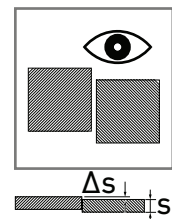

However, maximum of 5 mm for wall thicknesses of >30 mm and diameters $>d630$

Gap inspection (values as per DVS 2207-1):

d_n [mm]	Gap A [mm]
≤ 355	0.5
400-630	1.0
630-800	1.3
800-1000	1.5
> 1000	2.0

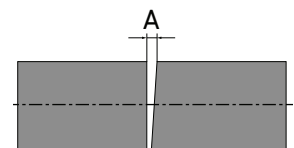

Remarks: According to DVS 2207, an additional cleaning of the prepared jointing surfaces is not necessary. For unfavorable weather influences, such as wind and dust, an additional clean of the planed pipe ends (pipe, fitting) with PE cleaner and lint-free, clean paper towels is necessary.

[5] Checking heating element temperature

Heating element surface temperature (in accordance with DVS 2207):

$220\text{ °C} \pm 10\text{ °C}$

Measurement with calibrated thermocontact measuring device within the welding zone at no fewer than eight points on the circumference of the heating element.

Welding starts at the earliest 10 min. after the target heating element temperature has been reached (time taken for the heating element to heat up evenly all over).

Then set heating element in heating element trigger mechanism.

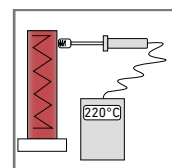

[6] Aligning/checking bead height

Equalize with alignment pressure = 0.15 N/mm^2 until minimum bead height is achieved.

The drag resistance of the machine and the pipe should be taken into consideration. Ensure that there is minimal movement resistance and use the roller blocks for the pipe sections.

In manually controlled fusion machines, see the machine's operating manual to determine the hydraulic pressure that needs to be set. In the case of CNC control, the machine automatically applies the correct parameters in accordance with the pipe wall thickness.

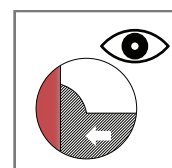

[7] Heat soak

For the heat soak, the contact pressure is reduced such that a transfer of heat from the heating element to the pipe ends is still ensured without uncontrolled opening as a result of the melt expansion.

Heating pressure $\leq 0.01 \text{ N/mm}^2$

In principle, it is essential to verify that the pipe ends remain in gentle contact with the heating element in this situation.

[8] Change-over

Wait until joint surfaces have been detached on both sides from the heating element by the trigger mechanism.

Move the heating element out of the welding area without causing harm to or contaminating the joint surfaces.

Change-over time as short as possible (keep the cooling of the joint surfaces as low as possible!). The maximum permissible change-over times in accordance with DVS 2207-1 should be observed.

[9] Joining and cooling

Bring the joint surfaces together quickly until they are just short of making contact.

Then, shortly before contact, bring the joint surfaces together with a speed close to zero.

Apply required **welding pressure of 0.15 N/mm^2** as linearly as possible (welding pressure set-up time).

Maintain welding pressure throughout the cooling time.

[10] Check and fusion protocol

The fusion connection must be checked over the entire circumference for **bead formation**. The fusion bead should be as even and smooth as possible over the complete circumference.

No unwelded points, bead discolorations or notches are permitted in the fusion connection. For additional faults, see DVS 2202 supplementary sheet 1.

Label fusion connection with:

- Welding number
- Cooling time (unclamping)
- Date
- Visa/signature

Then create manual fusion protocols or save the electronic log conveniently with the WeldinOne software.

[11] Leak test

In all cases, the cooling times as per DVS2207-1 or specific manufacturer specifications must be adhered to.

A pressure sample can only be **taken one hour after the end of cooling at the earliest**.

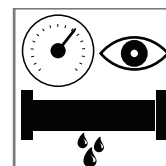
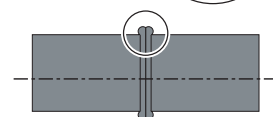
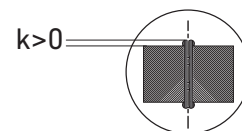
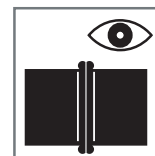
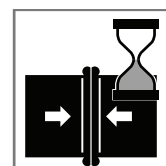
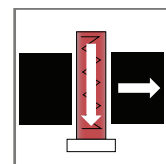
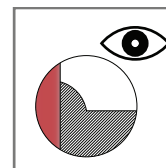

An overview of fusion parameters

The fusion parameters in accordance with DVS 2207-1 (August 2015) are summarized below:

Nominal wall thickness s (mm)	Equalizing	Heat soak	Change-over	Joining	Cooling time (min)		
	Minimum bead height* (mm)	Heating time (s)	Change-over time (mm)	Welding pressure set-up time (s)	<15 °C	15°–25 °C	25°–40 °C
≤ 4.5	0.5	≤ 45	5	5	4.0	5.0	6.5
4.5 – 7	1.0	45 – 70	5 – 6	5 – 6	4.0 – 6.0	5.0 – 7.5	6.5 – 9.5
7 – 12	1.5	70 – 120	6 – 8	6 – 8	6.0 – 9.5	7.5 – 12	9.5 – 15.5
12 – 19	2.0	120 – 190	8 – 10	8 – 11	9.5 – 14	12 – 18	15.5 – 24
19 – 26	2.5	190 – 260	10 – 12	11 – 14	14 – 19	18 – 24	24 – 32
26 – 37	3.0	260 – 370	12 – 16	14 – 19	19 – 27	24 – 34	32 – 45
37 – 50	3.5	370 – 500	16 – 20	19 – 25	27 – 36	34 – 46	45 – 61
50 – 70	4.0	500 – 700	20 – 25	25 – 35	36 – 50	46 – 64	61 – 85
70 – 90	4.5	700 – 900	25 – 30	35	50 – 64	64 – 82	85 – 109
90 – 110	5.0	900 – 1100	30 – 35	35	64 – 78	82 – 100	109 – 133
110 – 130	5.5	1100 – 1300	max. 35	35	78 – 92	100 – 118	133 – 157

(Intermediate values must be interpolated)



- * Equalize minimum bead height on the heating element at the end of the equalization time, join and cool with $p = 0.15 \text{ N/mm}^2$, heat soak with $p \leq 0.01 \text{ N/mm}^2$

5.2.3 Butt fusion machines

Butt fusion machines for trenches are generally subdivided into the following categories:

- Manual butt fusion machines: All butt fusion machines in series ECOS, TOP and GF are available with manual control.
- CNC butt fusion machines: All machines marked with CNC are equipped with automatic control of the fusion steps.

In addition to trench machines, special workshop machines are also used, allowing prefabrication of segment bends or other complex light-weight designs under controlled conditions in the workshop.

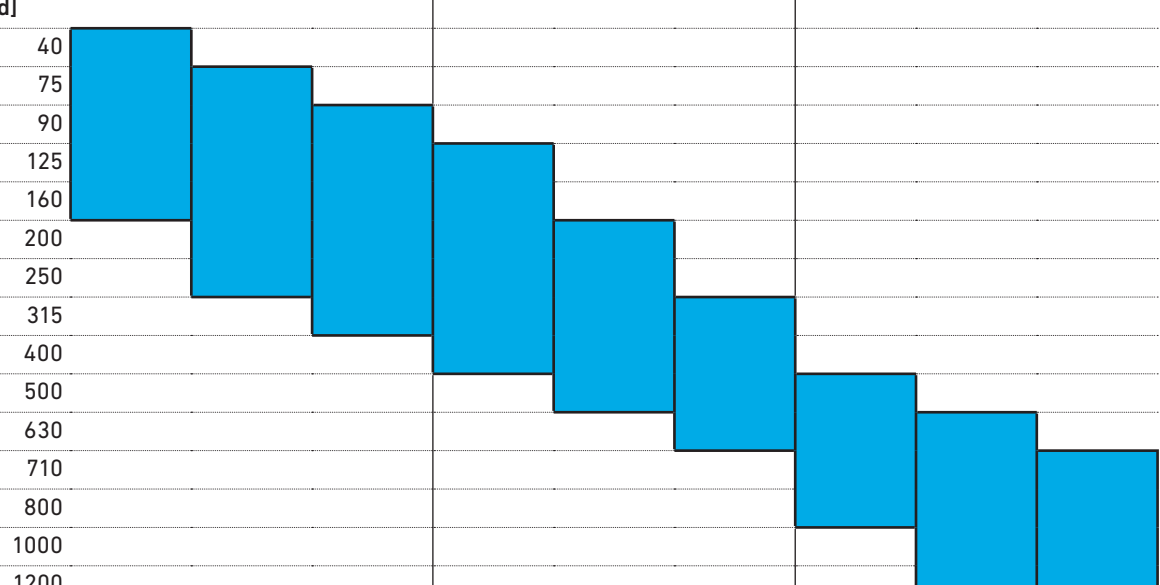
Characteristics	160	250	315	400	500	630	800	1000	1200
	 ECOS-TOP-CNC			 TOP-CNC			 GF		
Max. dimension (mm)	160	250	315	400	500	630	800	1000	1200
Material	PE, PP, PB			PE, PP, PB			PE, PP		
Temperature range (°C)	-10/+45			-10/+45			-10/+45		
Input voltage (V)	230/115	230	230	400	400	400	400	400	400
Operation	Manual, CNC			Manual, CNC			Manual		
Performance (W)	1900	3250	3850	5700	6300	11000	15000	19500	20500
Reduction clamp insets/flange adapter clamp	Optional			Optional			Optional		
Hoist unit	-			Optional			Optional		
Chamfered clamping saddle	Optional			Optional			-		
Fusion protocols, transfer via USB stick	WR 200 (optional), CNC			WR 200 (optional), CNC			WR 200 (optional)		
Traceability via bar code scanner	TOP, CNC			TOP, CNC			-		
Traceability (ISO 12176-4)	CNC			CNC			-		
Weight basic machine (kg)	22	47	53	95	169	222	690	1238	1370
Dimension range [d]									

5.2.4 Installation guidelines – fault prevention

Frequent causes of fault and remedial measures

Despite training, in practice faults arise which, if the trained professional personnel heed a few basic principles, can easily be avoided. The following lists causes of faults which can arise during butt fusion as a result of improper preparation:

Cause of fault	Remedial measure
Offset of the joint surfaces	Precisely align and securely clamp pipes. Use roller blocks. Align the ovalities of the jointing surfaces to one another or use rounding clamps.
Separating layer in the jointing surface or partially missing fusion pressure.	Thoroughly clean the heating element and jointing surfaces. Rigorous gap inspection of the circumference. Pay attention to the fusion parameters (heating element temperature, times and pressures in line with DVS).
Lack of equalization/welding pressure	Reduce the movement resistance (use roller blocks). Clarify/check the tensile strength of the fusion machine before starting the fusion (particularly for long relining pipe ends).
Early loading of the jointing	Comply with cooling time and avoid time pressure.
Use on an unsuitable pipe	Be sure to use only pipe ends with the same SDR level and same material.

Non-destructive fusion seam testing

In addition to optical inspections and destructive testing, GF Piping Systems offers the services of a non-destructive fusion seam test using an ultrasonic process. This can uncover faults early – as described in DVS 2202 – and guarantee the quality of butt fusion connections within a newly installed pipe section.

Enjoy the peace of mind of your reliable butt fusion connections and benefit from the GF Piping Systems' performance report with its ten-year warranty.

DVS 2202 supplement 1 (November 2014)

The DVS 2202 supplement 1 gives detailed descriptions of faults on heating element butt fusion connections. The following illustrates the most important faults without the further details of a description, test methods or evaluation criteria.

Outer finding of the jointing

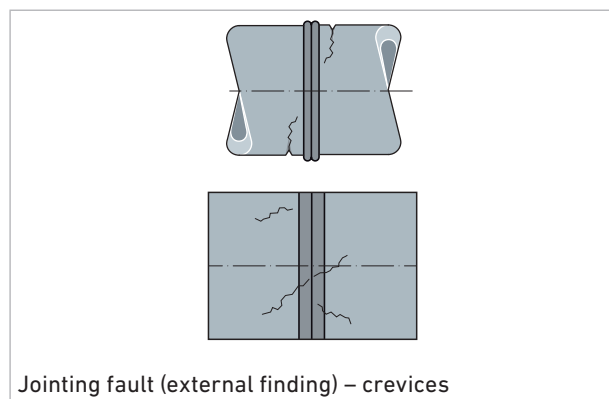

Crevices running lengthwise or at right angles to the weld bead.

They can lie as follows:

- In the weld bead
- In the base material



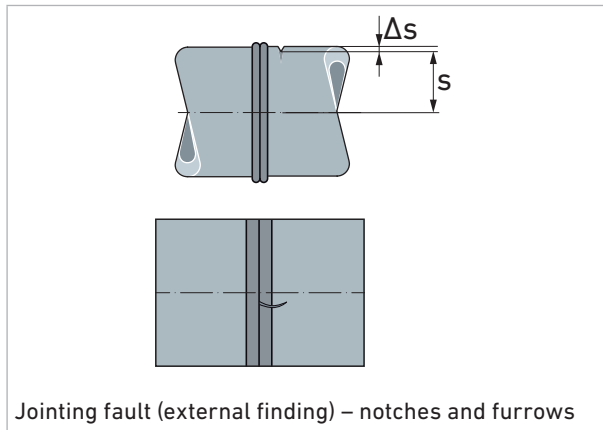

Notches and furrows in the base material not permissible for:

$$\Delta s > 0.1 \times s$$

lengthwise or at right angles to the weld bead which run into the bead area, e.g. caused by:

- Clamping tool
- Improper transport
- Faults in the welding seam preparation
- Permissible on site if it tapers out flat and the notch base is not sharp-edged

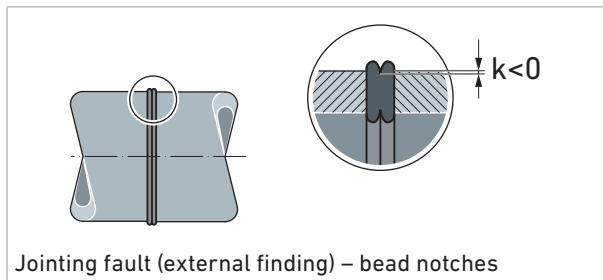

Bead notches not permissible for

$$k < 0$$

e.g. caused by:

- Insufficient welding pressure
- Cooling time too short
- Change of location of the tensioned pipe during the fusion process

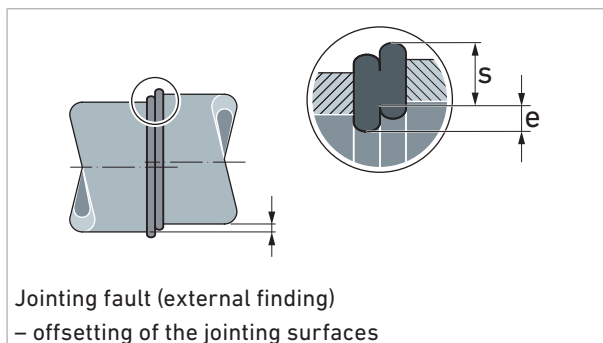

The jointing surfaces are offset against one another or the thickness differences are not adjusted.

Not permissible for:

$$e > 0.1 \times s \text{ or } > 5 \text{ mm}$$

- Depending on material and thickness, impairments to the joint seam quality can arise

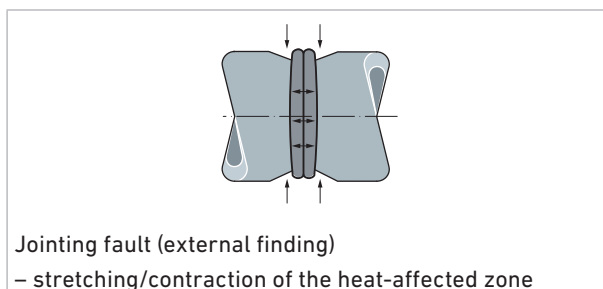

Stretching/contraction of the heat-affected zone, e.g. caused by:

- Impermissible application of force during the cooling phase

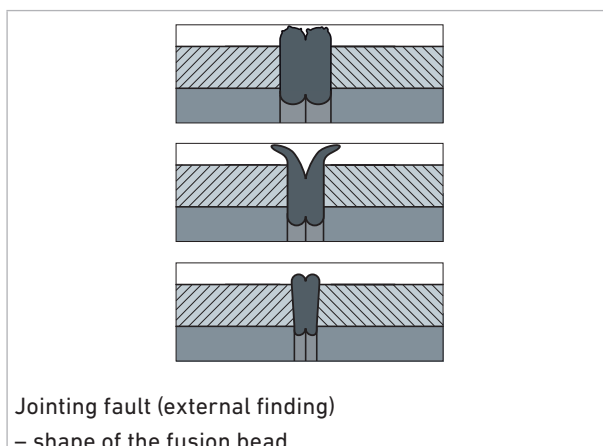

Shape of the fusion bead

For a multitude of materials and material types, as well as the possible fusion bead formations, it is not possible to give a standardized assessment system.

A verdict on the long-term behavior of the weld bead cannot be determined from the fusion bead's shape.

→ In case of doubt, please check the reference joint.

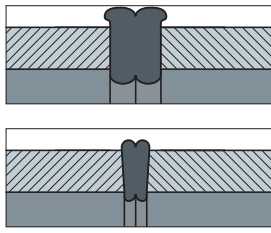

Jointing fault (external finding) – volume of the fusion bead noticeably small/large

Volume of the fusion bead is noticeably small/large

e.g. caused by wrong fusion parameters

- Perform comparison jointing (check fusion parameters)

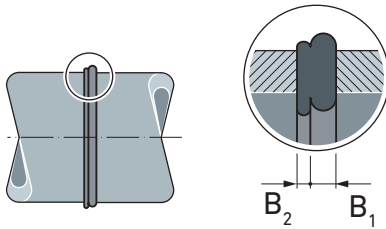

Jointing fault (external finding) – unequal fusion bead

Unequal fusion bead

Differently formed fusion beads, impermissible for:

$$B_2 \leq 0.7 \times B_1$$

Partly or over the whole length of the seam/the whole circumference:

- Tilting of the heating element
- Non-angular jointing plane
- Various MFRs of the jointing pairs (beads are different in size throughout)

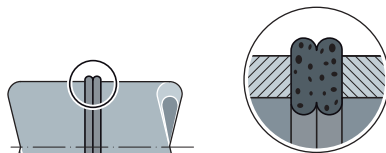

Jointing fault (external finding) – fusion bead with bubbles

Bead surface with bubbles e.g. caused by:

- Thermal damage – heating element temperature too high
- Moisture
- Material-dependent (PVC)

Inner finding of the jointing

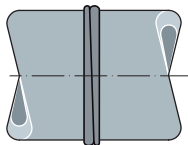

Jointing fault (internal finding) – lack of adhesion

Lack of adhesion

Incomplete or no adhesion of the jointing surfaces, partly or across the entire seam cross section, with/without bubbles or knots, e.g. caused by:

- Moisture
- Soiled jointing surfaces
- Oxidized jointing surfaces
- Change-over time too long
- Wrong heating element temperature
- Too little fusion force

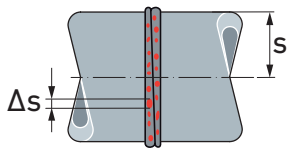

Jointing fault (internal finding)
– cavities (blow holes/voids)

Cavities e.g. blow holes/voids

Individual blow holes/voids or inclusions which are numerous scattered or in localized clusters, inadmissible for:

$\Delta s \text{ max.} = 0.05 \times s$

e.g. caused by:

- Formation of steam during fusion jointing (water, solvent, cleaner, etc.)
- Insufficient welding pressure
- Cooling time too short

Remark: Depending on material and thickness, physical properties can cause shrinkage cavities in materials with a high crystallinity.

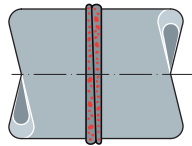

Jointing fault (internal finding)
– inclusion of contaminants

Inclusion of contaminants

e.g. caused by

- Soiled heating element
- Contaminated jointing surfaces

5.3 Heating coil/electric jointing

5.3.1 Overview

Material

- PE

Fusion device

Sealing system cross section

Macro view

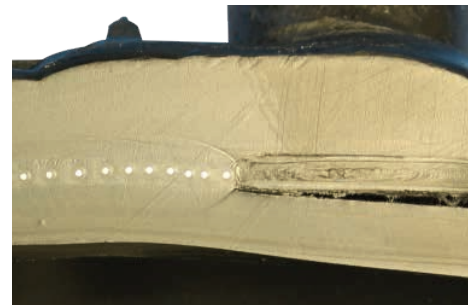
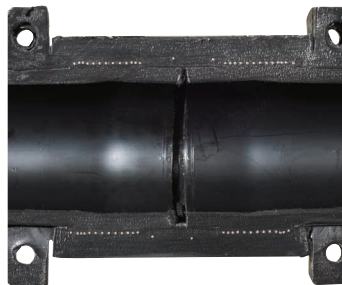

5.3.2 Fusion procedure

For heating element fusion jointing, the plastic pipes in **A** are connected using electrofusion fitting **B** until they are pull-out resistant and are permanently connected together.

The electrofusion fittings are equipped with integrated resistance wires to which electric current is applied during the fusion process. This heats the inside of the fittings and the outside of the pipe to the fusion current temperature and melts them.

The measurements of the pipe end and fitting coupler correlate in such a way that a fusion pressure is obtained during jointing, resulting in a homogeneous joint. The welding pressure in the polymer melt required for the welding is the result of the volume increase of the melt and the fitting design. The welding energy required for the fusion jointing is supplied by the fusion device. The fusion data transfer of the fittings is carried out using bar codes which are logged with the fusion device. After cooling, the result is a permanent, homogeneous joint.

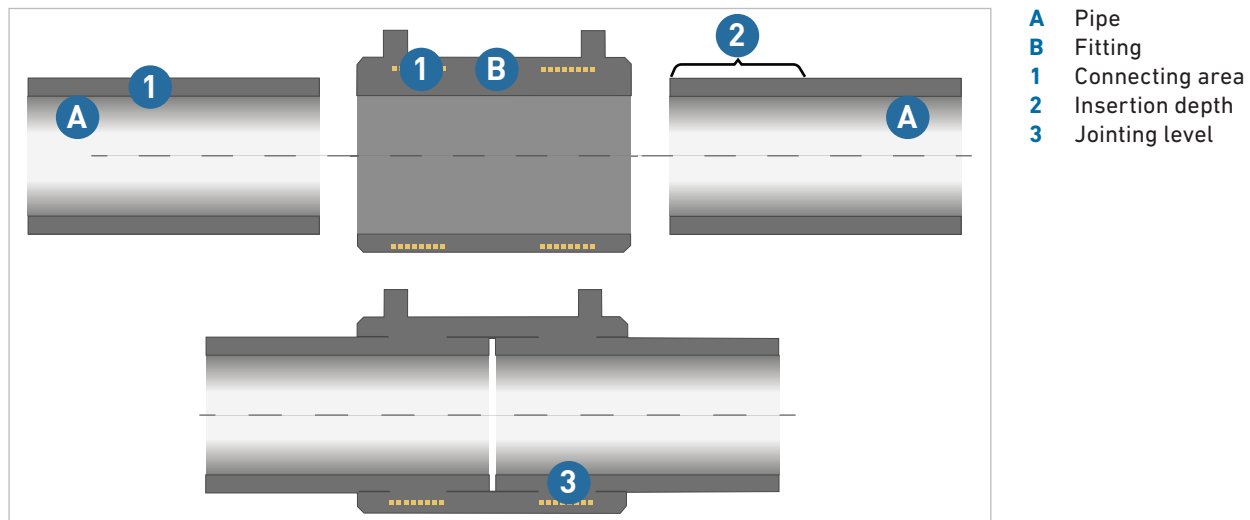

- A** Pipe
- B** Fitting
- 1** Connecting area
- 2** Insertion depth
- 3** Jointing level

5.3.3 Advantages and properties

The use of electrofusion for jointing of pipes and fittings allows safe, rational, economic and efficient assembly of underground and above ground PE piping systems.

Advantages

- Integral connections PE-PE, meaning no sealing element is required
- Pull-out resistant, so no buttress is required for underground lines
- The jointing of pipes of the same material types, PE 80, PE 100, PE 100-RC as well as combinations thereof
- Different SDR classes can be welded together
- No fusion bead on the inside of the pipe
- Low space requirement for execution because of lightweight and compact fusion devices
- Fast pipe-laying speed (compared to conventional butt fusion) due to the low bondedness of the fusion device
- Fully automatic fusion process (high process reliability)
- Gap-free traceability through fusion protocols and identification of the welded components
- Low investment needed because welding of all dimensions takes place with one fusion device



For additional information about using the fusion procedure for corresponding materials, see www.gfps.com.

5.3.4 Basic information about welding seam preparation (electrofusion)

Separating pipes

Remove the most significant dirt from the pipe's working area. If water is used, the pipes must be completely dry prior to separation. Then separate the pipe ends at a right angle with the pipe separating device and deburr the cut surfaces. The tools must neither permanently deform nor damage the pipe. The use of lubricants during separation is not permitted. Suitable tools for this are pipe cutters or a guided electronic pipe saw.



Peeling

PE pipes are often stored unprotected from direct sunlight or dirt. They must be machined with a suitable peeling tool directly before the start of welding. In the injection-molded products, peeling is not required if they were stored correctly.



It is in principle possible to peel spigot ends on fittings (spigot fittings, ball valves or transition adaptors) if this is required by the processor. This does not have a negative impact on the welding result, provided that peeling is carried out correctly and the resulting diameter of the spigot end is within the tolerance of the permitted diameter after peeling (see table below).

In the area of the fusion zone, the pipe surface must be machined without gaps. For the reliable removal of the oxide layer, a rotary peeler should be used with a constant wall thickness removal of ≥ 0.2 mm. The peeling result is to be checked for even chip formation and min. cut depth. The peeled area must not be subsequently touched.

It is important to ensure a small annular gap formation between fitting and pipe! Therefore, regularly check the quality and wear and tear of the peeling blade on the peeler. In cases of doubt regarding too much wall removal, see the minimum permitted pipe diameters below!

Flat spots, bulges, scratches and furrows are not permitted on the welded area after peeling! For verification of peeling after welding, at least 1 cm must be added to the insertion depth of couplers and fittings and 4 cm to the length of a saddle.

Nominal pipe outer diameter d_n (mm)	Min. permitted pipe outer diameter after peeling (mm) at 20° C*
20-25	$d_n - 0.4$
32-63	$d_n - 0.5$
75-225	$d_n - 0.6$
250-315	$d_n - 0.7$
>315	$d_n - 0.8$

* If ambient temperature varies greatly, the nominal diameter d_n is to be converted with the formula:

$$d_n = d \cdot \left(1 + \frac{\alpha}{3 \cdot \Delta T} \right)$$

$$\alpha = 0.00015 \text{ bis } 0.00020 \frac{\text{mm}}{\text{mm} \cdot \text{K}}$$

Example for d225:

$$d_n = 225.0$$

Min. permitted pipe diameter after peeling:

$$225.0 \text{ mm} - 0.6 \text{ mm} = 224.4 \text{ mm}$$

Measure using circumeter.

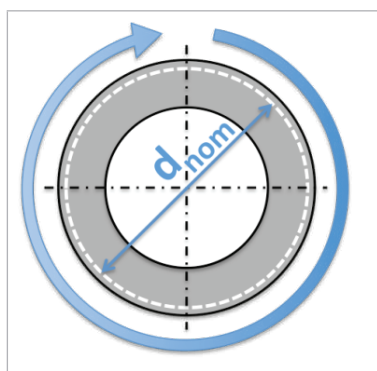

5.3.5 Ovality

During welding, the ovality must be within the tolerances defined in the standards. As a general rule, the values from DVS2207-1 can be used.

If the values are outside the tolerance range, measures must be taken, e.g. the use of re-rounding tools.

DVS 2207-1 permits a maximum pipe ovality of 1.5 % or a maximum of 3 mm. For larger ovalities, use re-rounding clamps as a general rule.

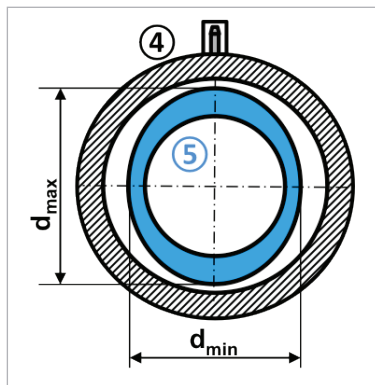

- 1 Fitting
- 2 Pipe

5.3.6 Pipe end reverse

If there is excessive reverse on the pipe ends, the heating coil zones must be sufficiently covered. In cases of doubt, visually check the pipe ends with a spirit level and compare reversed lengths with half inner cold zone. If necessary, cut pipe ends to size at right angles directly before welding.

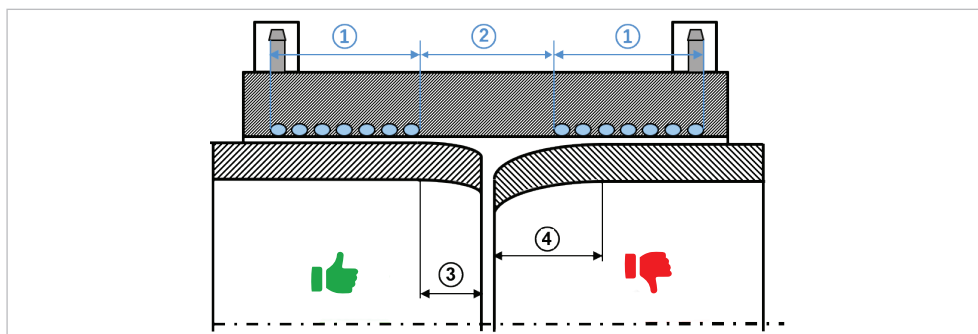

- 1 Heating coil zone
- 2 Internal cold zone
- 3 Permitted pipe end reverse
- 4 Impermissible pipe end reverse

5.3.7 Cleaning

As a result of the manufacturing process, the heating coil is completely embedded in the fitting. The closed, smooth inner surface of ELGEF Plus electrofusion fittings allows for easy and residue-free cleaning of construction site dirt like dust, sand, and mud.

The PE cleaner (e.g. Tangit PE cleaner), or PE cleaning cloths dampened with cleaner by the manufacturer in a closable plastic box must be a 100% rapidly vaporizing liquid. Agents tested in accordance with DVGW VP 603 or NTA8828 meet this requirement. The use of alcohol/water mixtures available commercially can, as a result of the water they contain, lead to a reduction in quality, so they must not be used. The paper for cleaning must be clean, unused, absorbent, lint-free and not colored. Cleaning cloths soaked with Tangit PE cleaner are permitted.

Cleaning can only be carried out on the peeled welded area. Otherwise, there is the risk of dirt being transferred to the cleaned surface. If marker pens are used, it is essential to ensure that no ink gets into the fusion zone area. If subsequent cleaning is required, the ink must not be wiped in the fusion zone. Ink that gets into the fusion zone cannot be completely removed even with repeated cleaning. The pipe must be re-machined or replaced.

During welding, the contact surfaces must be clean and dry. It is necessary to ensure that cleaning agents are completely vaporized without residue prior to welding. This applies in particular for cold temperatures, as the cleaner vaporizes more slowly than in warm temperatures.



i Particularly when using bentonite in trenchless laying, it is essential to thoroughly clean the pipes in the fusion zone area!

5.4 Installation process

The following installation process is representative for all ELGEF Plus couplers and fittings. The detailed, individual installation process can be accessed online by scanning the QR code on the bag packaging with your smartphone.

For detailed information, please see our website www.gfps.com or contact your regional GF sales office.

The following figures are examples showing the important installation steps for the ELGEF Plus electrofusion range. The important action steps can be transferred to other products not explicitly represented here.

5.4.1 Installation instructions for electrofusion coupler ELGEF Plus d20 to d63mm

230 V

Alcohol >99%

PERMANENT

1

2

ømm	mm
20	45
25	45
32	46
40	50
50	54
63	58

3

4

5

ømm	mm
20	35
25	35
32	36
40	40
50	44
63	48

6

7

8

9

10

11

12

13

14

Abkühlzeit (CT) und Druckprüfung respektieren
Respect cooling time (CT) and test pressure

15

5.4.2 Installation instructions for electrofusion saddle ELGEF Plus d63 to d250mm

1 $+2\text{cm}$ X $+2\text{cm}$

2 $\geq 0.2\text{ mm}$

3 LINT-FREE PAPER PE

4 KEEP CLEAN

5 $\varnothing 180 - \varnothing 250$

6 $\varnothing 63 - \varnothing 160$

7

8

9 ELGEF+

10

11

Abkühlzeit respektieren
Respect cooling time

Mechanisch belasten, Anbohren drucklos Mechanical load, pressureless tapping	Dichtheitsprüfung / Anbohren unter Betriebsdruck Leak test / Tapping under operating pressure	STP 6 bar (min.)	STP 18 bar (min.)
20	30	90	

STP = Systemprüfdruck System Test Pressure

12

13

14

(Optional)

5.4.3 Installation instructions for electrofusion coupler ELGEF Plus d355 to d800mm

Approved PE cleaner Alcohol >99%

PERMANENT

90°

(EN 1555 EN 12201)

>3mm

<3mm

X

X+10 mm

X+10mm

≥0.2 mm

LINT-FREE PAPER PE

KEEP CLEAN

KEEP CLEAN

X:2

X

X:2

KEEP CLEAN

X:2

1800

Abkühlzeit (CT) respektieren
Respect cooling time (CT)

Abkühlzeit (CT) und Druckprüfung respektieren
Respect cooling time (CT) and test pressure

5.5 Cooling times

5.5.1 ELGEF Plus coupler and fittings

After the fusion process, our MSA electrofusion units directly display the cooling time after which the clamping tool can be removed. If other electrofusion units are used, the cooling time up to removal of the clamping tool is indicated on the bar code label with "CT". After this cooling time, the fusion connection can be moved.

The extended cooling durations specified in the table below are applicable to the load capacity during the leak test. The reference temperature for the cooling times is not standardized and is set by the fittings manufacturer.

Cooling times for ELGEF Plus coupler and fittings

d _n (mm)	Remove clamping tool (min.)	Leak test*	
		STP ≤ 6 bar (min.)	STP ≤ 18 bar (min.)
20-63	6	10	30
75-110	10	20	60
125-160	20	30	75
180-225	20	45	90
250-315	30	60	150
355-400	60	120	180
450-630	60	150	210
710-800	90	150	240
900-1200	60	150	240

* Includes the cooling time to remove the clamping tool
STP = system test pressure.

The cooling time specifies how long it takes for the fusion connection to cool to a corresponding reference temperature. The reference temperature is a measure for the stability of the connection and thus what loads/stresses the connection can be subjected to. For removal of the clamping tool, Georg Fischer uses a reference temperature of 110 °C, a reference temperature of 80 °C for an internal pressure of 6 bar and a reference temperature of 20 °C (ambient temperature) for an internal pressure of 18 bar.

5.5.2 Cooling times for ELGEF Plus saddles and PVTs

After the fusion process, our MSA electrofusion units directly display the cooling time after which the fusion connection can be mechanically loaded. If other electrofusion units are used, the cooling time up to removal of the clamping tool is indicated on the bar code label with "CT". The extended cooling durations specified in the table below are applicable to the load capacity during the leak test.

Minimum cooling time for ELGEF Plus saddles and pressure tapping valves (PTVs)

d _n (mm)	Mechanical load, pressureless drilling (min.)	Leak test/drilling under working pressure	
		STP ≤ 6 bar (min.)	STP ≤ 18 bar (min.)
40, 50 monoblock	10	20	30
63-160 monoblock	20	30	90
63-400 duoblock	20	30	90
110-630 branch saddle	30	45	90
Branch saddle topload 315 – 1000 x outlet 160/225	45	90	180
Branch saddle topload 500 – 2000 x outlet 315/500	60	120	240

STP System test pressure

The cooling time specifies how long it takes for the fusion connection to cool to a corresponding reference temperature. The reference temperature is a measure for the stability of the connection and thus what loads/stresses the connection can be subjected to. For removal of the clamping tool, Georg Fischer uses a reference temperature of 110 °C, a reference temperature of 80 °C for an internal pressure of 6 bar and a reference temperature of 20 °C (ambient temperature) for an internal pressure of 18 bar.

5.6 Installation guidelines and fault prevention

Frequent causes of fault and remedial measures

Despite training, in practice faults arise which, if the trained professional personnel heed a few basic principles, can easily be avoided. The following lists causes of faults which can arise for heating element fusion joints as a result of improper preparation:

Cause of fault	Remedial measure
Wrong, insufficient or excessive peeling	Suitable peeling device and regular maintenance
Poor cleaning (sand, grease, hand perspiration)	Only in the peeled area; clean, lint-free paper towel; 100% evaporating solvents
No stress-free installation	Use of clamping devices
Insertion depth, assembly not heeded	Mark correctly and follow instructions
Ovality (ring coil and large dimensions)	Use of rounding saddles
Impermissible pipe end reverse	Cutting the pipe ends
Wrong fusion data	Data only from the current fitting
Cooling time too short	Avoid time pressure

Non-destructive fusion seam testing

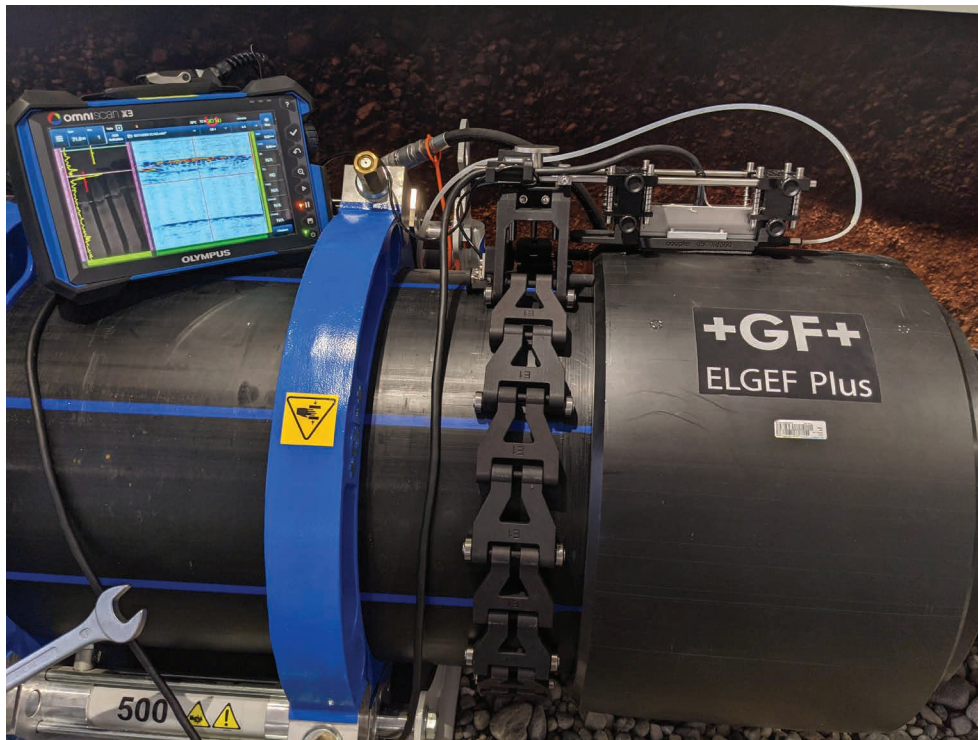

In addition to optical inspections and destructive testing, GF Piping Systems offers the service of a non-destructive fusion seam test using an ultrasonic process. This can uncover faults early – as described in DVS 2202 – and guarantee the quality of electrofusions within a newly installed pipe section.



DVS 2202 supplement 2 (November 2012)

DVS 2202 supplement 2 "Evaluation of faults at thermoplastic connections of pipe components and tables – heating element fusion jointing (HM)" describes the faults for heating element fusion joints in detail. The following illustrates the most important faults without going into further detail with a description, test methods or evaluation criteria.

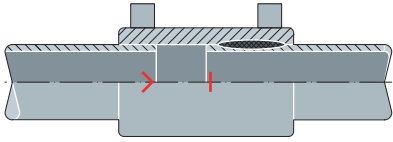
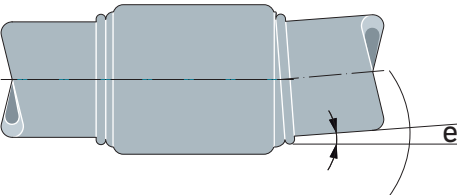
Outer finding of the jointing

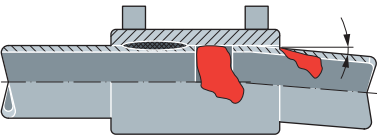
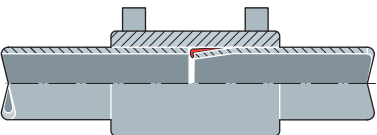
Representation	Description of fault
	Insertion depth not marked correctly or at all
External electrofusion fault – insertion depth	There is no visible mechanical machining extending beyond the fitting body, or the visible mechanical machining is e.g.: <ul style="list-style-type: none"> • Irregular • Insufficient (chip thickness) • Not continuous • Not present • Excessive (pipe undersized) • Inadmissible (manual scraping for PE-X)
External electrofusion fault – insufficient peeling	Pipe fused into the fitting at an angle on one or both sides e.g. caused by: <ul style="list-style-type: none"> • Alignment fault • Change of position during fusion jointing • Inadmissible, if $e \geq 1^\circ$ Remarks: The angle offset is a fault which can result in further faults.
	External electrofusion fault – angle fault
External electrofusion fault – melt emergence	Fusion emergence from the fitting on one or both sides, localized or throughout, e.g. caused by: <ul style="list-style-type: none"> • Fusion energy too high (wrong bar code) • Fusion time too long (mismatched temp. fitting and fusion device) • Re-fusion immediately repeated • Gap too big • Twists • Fusion device faults
	External electrofusion fault – melt emergence
<p>Inner finding of the jointing</p>	
Representation	Description of fault
	Angular deviation with displacement of heating coil and melt with or without separations in the joining plane, increased material flow, for example caused by: <ul style="list-style-type: none"> • Non-flush pipe ends • Inadequate curvature radii in the case of ring coils • Bending moment on the fitting • Movement during welding
Internal electrofusion fault – twisting	
	Faults with possible fusion emergence and change of position of the heating coil caused by: <ul style="list-style-type: none"> • Extreme pipe end reverse
Internal electrofusion fault – reversed pipe ends	

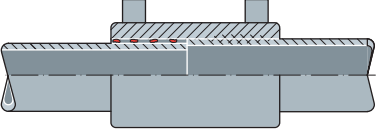
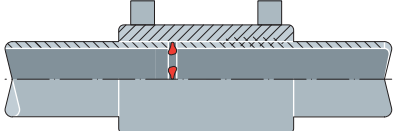
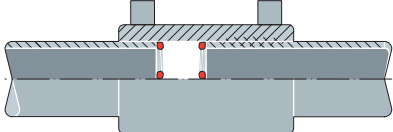
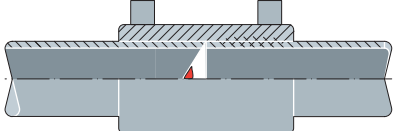
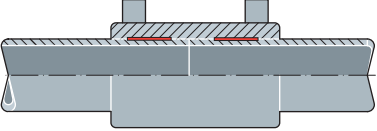
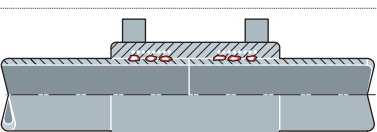
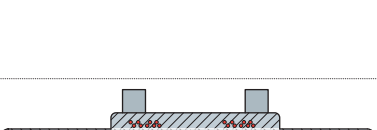
Representation	Description of fault
	<p>Channel formation locally, over large axial areas or radially around the circumference, e.g. caused by:</p> <ul style="list-style-type: none"> • Notches and/or furrows in the pipe surface • Deviating diameter tolerance (undersized pipe) • Incorrect peeling • Mechanical damage • Flaking
<p>Internal electrofusion fault – shape inaccuracy</p>	
	<p>Pipe ends offset on one or both sides in the fitting or not touching each other or the stop, melt emergence on the inside or outside, e.g. caused by:</p> <ul style="list-style-type: none"> • Uneven pipe insertion
<p>Internal electrofusion fault – uneven pipe insertion</p>	
	<ul style="list-style-type: none"> • Insufficient pipe insertion on one or both sides (insufficient coverage of the heating coil)
<p>Internal electrofusion fault – pipe not fully inserted</p>	
	<ul style="list-style-type: none"> • Pipe end not cut off at a right angle
<p>Internal electrofusion fault – pipe cut off at an angle</p>	
	<p>Incomplete joint locally or over large areas with or without separation in the jointing plane e.g. caused by:</p> <ul style="list-style-type: none"> • Not enough fusion energy (e.g. premature fusion termination, wrong fusion data) • Moisture • Contaminated surface • Impermissible material combinations
<p>Internal electrofusion fault – inadequate material bond</p>	
	<p>Cavities (e.g. voids, blow holes) caused by:</p> <ul style="list-style-type: none"> • Gap too big • Contraction • Moisture (water/formation of condensation/frost or cleaning agents) • Inclusion • Overheating
<p>Internal electrofusion fault – cavities</p>	
	<p>Remarks: Depending on the system, in particular for diameters >d250mm, cavities can form</p> <p>Wavy, uneven, amassed or shifted heating coil in the fusion plane, e.g. caused by:</p> <ul style="list-style-type: none"> • Overheating of fusion seam (wrong fusion data, mismatched temperature between fusion device and fitting) • Soiled jointing surfaces • Twists • Tolerance of jointing parts exceeded • Pipe cut off at angle or pipe ends reversed
<p>Internal electrofusion fault – displaced wires</p>	

Representation

Description of fault

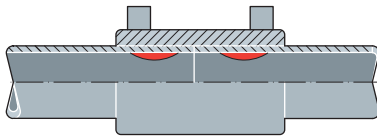

Wall thickness of the pipe is outside of the SDR range specified by the fitting manufacturer

Internal electrofusion fault
– SDR class of pipe not permissible

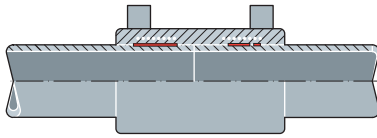

Axial separation or detachment locally or over large areas, e.g. caused by:

- Contaminated surfaces (e.g. dirt, grease, dust etc.)

Internal electrofusion fault
– inclusion of contaminants

Additional testing for saddle molding parts

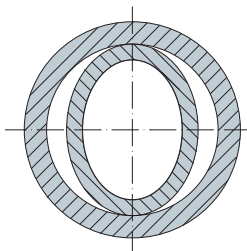

Lack of adhesion caused by insufficient fit in the fusion plane.
Caused by insufficient axial or radial fit in clamped saddles, e.g. caused by:

- Clamping tool positioned incorrectly or not at all
- Incorrect use of the saddle's clamping system
- Drilling before fusion jointing
- Drilling before end of cooling time

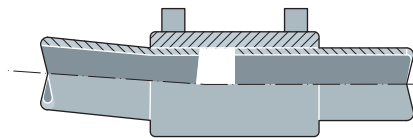

Lack of adhesion caused by insufficient material-material connection in the fusion plane (pipe) caused by shape faults.





Inadequate welding locally or over large areas, e.g. caused by:

- Deformed pipe
- Ovality
- Pipe bend (in coils)

6 Mechanical jointing technology





6.1 Overview

GF Piping Systems provides a wide range of solutions for mechanical joints. The table below provides details about the traditional methods commonly employed in industrial piping system construction:

	Transition adaptor (Section 6.2)	MULTI/JOINT® 3000 Plus (Section 6.3)	ST system (Section 6.4)	Flange (Section)	Multi/clamp (Section 6.5)
					
Connection type	Thread	Long-range fittings	Pipe-specific fittings	Flange connection	Repair saddle
Gasket	Teflon band on site	Sealing system	Special seal	Profile gasket/ flat gasket	Special seal
NBR		✓	✓	✓	✓
EPDM		✓	(✓)	✓	✓
Pipe materials	Metal thread	All	All	Plastic or metal	All
Dimension range					
d _n	DN				
20-63	15-50	✓	-(✓ DN40/DN50)	-(✓ DN40/DN50)	✓
75-110	65-100	-	✓	✓	✓
125-160	100-150	-	✓	✓	✓
180-225	150-200	-	✓	✓	✓
250-315	250-300	-	✓	✓	✓
355-630	350-600	-	✓	✓	✓
710-1000	700-1000	-	✓	✓	✓
			(max. DN1025)		
1200-2200	1200-2200	-	-	✓	-
Pressure range					
Gas	PN10	PN8*	PN4*	PN5	PN8*
Water	PN16	PN16/25*	PN10-25*	PN16	PN16*
Maximum temperature range	-10 °C to 40 °C	-5 °C to 50 °C	-10 °C to 50 °C	-10 °C to 50 °C	-10 °C to 70 °C
Applications**	G/W/P	G/W/P	G/W/P	G/W/P	G/W/P

* Note dimension-related pressure reductions in larger sizes

** G = gas, W = drinking water/waste water, P = industrial and building technology applications

	UNI-Coupling (Section 6.6)	PRIMOFIT (Section 6.7)	iJOINT (Section 6.8)	PP saddles (Section 6.9)
				
Connection type	Pipe clip/ repair coupling	Metal clamp fitting	PP clamp fitting	PP clamp fitting
Gasket	Special seal	Profile gasket	Lip gasket	Special seal
NBR	✓	✓	-	✓
EPDM	✓	✓	✓	✓
Pipe materials	Plastic or metal	Plastic or metal	Plastic	Plastic
Dimension range				
d_n	DN			
20-63	15-50	✓	✓	✓
75-110	65-100	✓	✓	✓
125-160	100-150	✓	-	✓
180-225	150-200	✓	-	✓
250-315	250-300	✓	-	✓
355-630	350-600	✓	-	-
710-1000	700-1000	✓	-	-
1200-2200	1200-2200	(d_n 2000)	-	-
Pressure range				
Gas	PN10*	PN10	-	-
Water	PN16*	PN16	PN16	PN16*
Maximum temperature range	-20 °C to +80 °C	-20 °C to +40 °C	-10 °C to +45 °C	-20 °C to +60 °C
Applications**	G/W/P	G/W/P	W/P	W/P

* Note dimension-related pressure reductions in larger sizes

** G = gas, W = drinking water/waste water, P = industrial and building technology applications

6.2 Transition adaptor



Functional principle

Transition adaptors have a pipe thread on one side (R/Rp/G) and a PE spigot end on the other side. This allows a connection to be made on one side with a metal pipe or a metal valve, gasketed in the thread using hemp or Tangit UNI-LOCK. The electrofusion connection is then achieved on the other side using a polyethylene pipe or electrofusion fitting.

For subterranean installations, metal parts must be protected against corrosion. Corrosion protection bands or similar should be used for this.

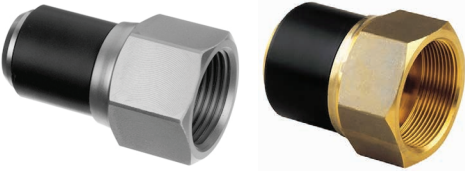

System overview

Transition adaptor		
	Ms58	Stainless steel (1.4305)
<p>Male thread</p> 	PE 20-63 ½" to 2"	PE 20-63 ½" to 2"
<p>Female thread</p> 	PE 20-63 1" to 2"	PE 20-63 1" to 2"
<p>Loose nut</p> 	PE 20-63 ¾" to 2"	-

System advantages

ELGEF Plus transition fittings dn 20-63 modular system ELGEF Plus electrofusionable transition couplers and moldings of dn 20-63 are built up as a modular system. A wide range of transition variants can be created from one coupler or fitting.

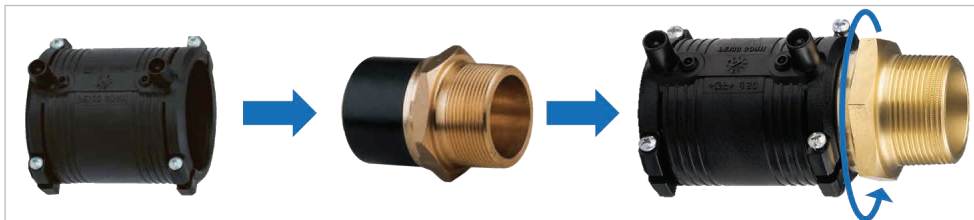

This increases your installation flexibility and reduces the necessary warehouse space:

- Complete system with few component parts
- Up to 50% reduced storage value
- Flexible assembly with valves thanks to the possibility of rotating and screwing the adaptor until just before welding begins
- Materials approved for use with drinking water – in a choice of dezincification-free brass or stainless steel

This flexibility makes assembly easier and faster – and reduces your installation costs.

These transition adaptors can only be used in conformity with the system – in connection with ELGEF Plus electrofusion fittings!



6.3 MULTI/JOINT® 3000 Plus – multi-range fitting with a restraint pull-out resistance system

Functional principle

The pull-out resistant jointing of pipes with long-range fittings is performed through compression of the sealing system and the “clawing” of stainless steel gripping elements into the pipe surface.

Tightening of the screws and nuts causes the Uni/Fiks or Uni/Fleks ring to be pressed onto the pipe surface. In the pull-out resistant model, the Uni/Fiks ring is provided with stainless steel gripping elements (Uni/Fikser) at the factory, which transfer the axial forces (through the internal pressure or tensile forces that occur), to the pipe surface and as a result create a restraint connection.

The MULTI/JOINT® 3000 Plus products made of EN-GJS-450-10 are provided with a corrosion resistant Resicoat® epoxy powder coating. This coating guarantees a long lifespan. The coating system has been developed for 50 years of use under maximum working pressure and is completely maintenance free. The MULTI/JOINT® 3000 Plus fittings are therefore best suited for water and gas line systems and for repair work. As a result of this unique light-weight design, use is possible on all pipe materials.

The MULTI/JOINT® 3000 Plus fittings have a very large clamping range of up to 43 mm. This flexibility of diameter enables straightforward jointing of DN50 to DN1025 pipes of various materials.

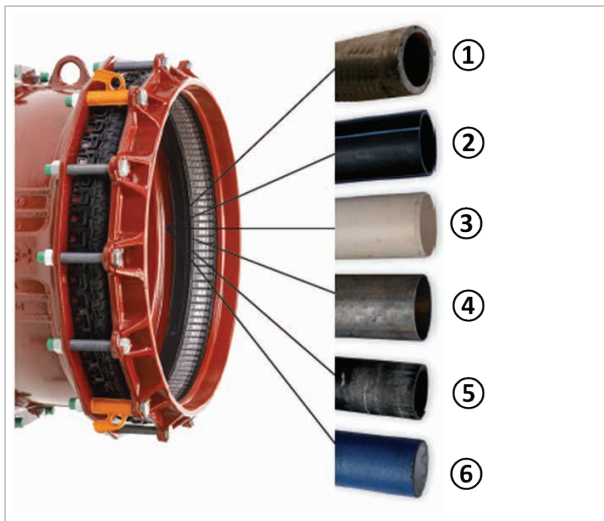

- 1 Asbestos cement (AC)
- 2 Polyethylene (PE)
- 3 Polyvinyl chloride (PVC)
- 4 Stainless steel/steel (St)
- 5 Ductile cast iron (DG)
- 6 Copper (Cu), polypropylene (PP), acrylonitrile-butadiene-styrene (ABS)

Uni/Fleks seal system

The Uni/Fleks seal system consists of plastic segments with a special rubber seal (varioseal). This seal system is a reliable solution for water and gas applications. Fittings with a Uni/Fleks sealing ring are used as a non-pull-out resistant connection system. For gas and H₂ applications, an NBR type seal is always required.

Uni/Fiksers

The stainless steel Uni/Fiksers enable optimum pull-out resistant jointing for all pipe materials.

Uni/Fiks sealing ring

For Uni/Fiks sealing rings, stainless steel grip elements (Uni/Fiksers) are inserted into the Uni/Fleks ring at the factory. This allows the Uni/Fiks sealing ring in the system to have a pull-out resistant connection for a max. working pressure of 16 bar for water and 8 bar for gas applications for metal pipes and plastic pipes.

Progressive sealing and gripping mechanism

The plastic segments for sealing ring sizes DN50 – DN125 are one-piece and consist of POM. Furthermore, the sealing ring design covers a wide range of outer pipe diameters. The plastic segments of the sealing ring sizes DN150 – DN1025 consist of two parts: wedge and topple (wedge-type guiding). The wedge consists of POM and is the fastener for the Uni/Fiksers which remain in contact with the pipe material in the pull-out resistant model. The topple consists of polyamide (PA6) and guarantees the integrity of the sealing ring. This combination made the progressive sealing and gripping mechanism perfect. The sealing rings in dimensions DN425 – DN1025 are equipped with an additional clip function. This affixes the ring to the body of the fitting to guarantee simple installation.

System components

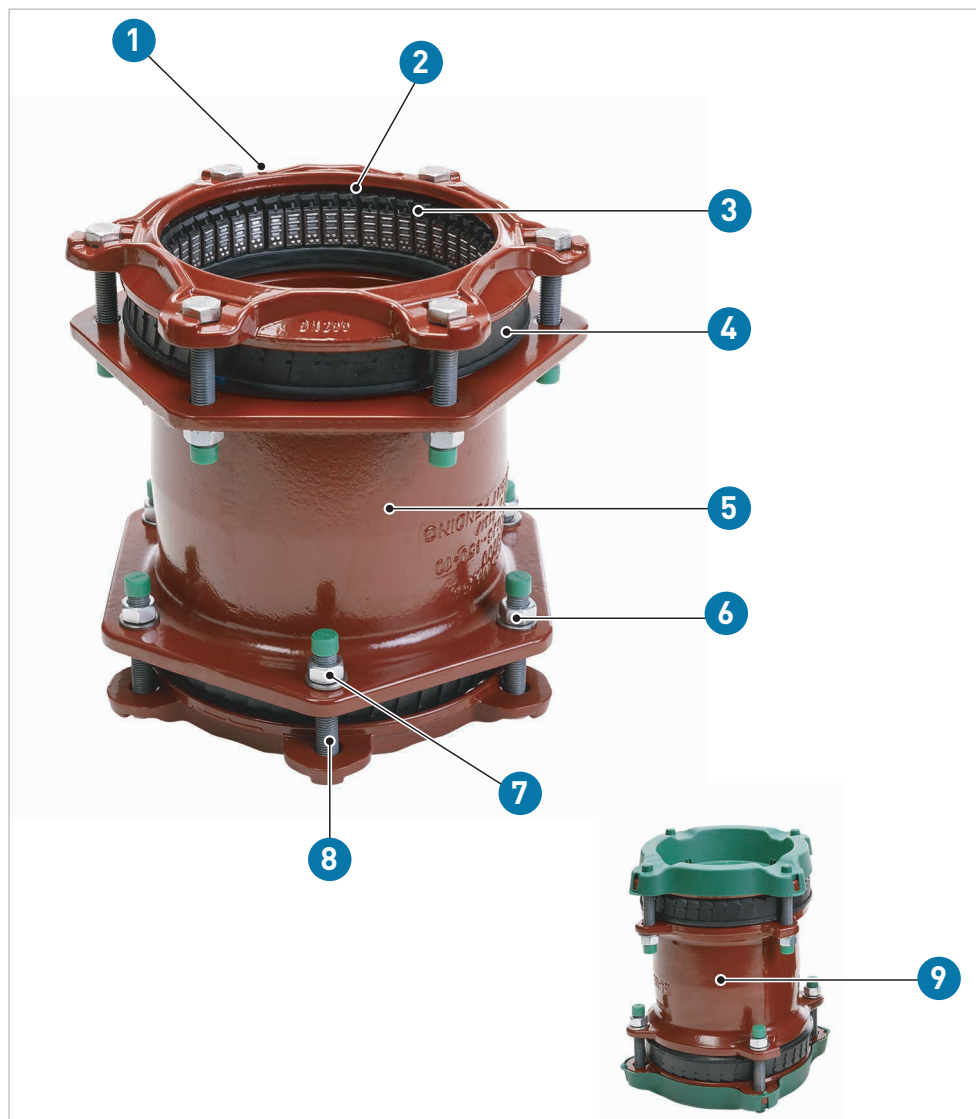

- 1 Pressure ring: GGG45 EN-GJS-450-10 with Resicoat® Epoxy powder coating, type RT 9000 R4
- 2 Uni/Fleks sealing ring
- 3 Uni/Fiksers: Stainless steel A4 (AISI 316)
- 4 Varioseal: Gasket (EPDM or NBR)
- 5 Body: GGG45 EN-GJS-450-10 with Resicoat® Epoxy powder coating, type RT 9000 R4
- 6 Nuts: Stainless steel A2 (AISI 304), galvanized
- 7 Washers: Stainless steel A2 (AISI 304)
- 8 Screws: Stainless steel A2 (AISI 304), LUBO coated
- 9 Hygiene protection: Protects the MULTI/JOINT® against soiling up to the time of assembly (cap in the picture: DN50 – DN400)

System overview

Coupling



E-piece



Endpiece



Coupling reduced



E-piece reduced



End cap with internal thread



Foot bends (N-piece) reduced



PE adaptor



90° bend



System advantages

MULTI/JOINT® 3000 Plus – reliable and proven system

MULTI/JOINT® has proven itself for over 30 years as a reliable and safe repair fitting system for gas and water utilities, as well as in worldwide waste water and industrial applications.



MULTI/JOINT® 3000 Plus – saves costs → pull-out resistant

The unique leakproof system and holding fixture of MULTI/JOINT® 3000 Plus allows you to create permanently leak-proof, pull-out resistant joins up to DN1025. This simplifies repair work by eliminating the need for costly and time-consuming concrete abutments in the jointing area.

The pull-out resistance increases the reliability of the jointing for:

- Alternating directions of current
- Hydraulic shocks
- Earth movement and settling



MULTI/JOINT® 3000 Plus – saves costs → less storage

The large clamping range of the MULTI/JOINT® 3000 Plus system covers all pipe materials and the widest range of outside diameters.

This saves storage space and significantly reduces the capital commitment for the rarely used repair fittings.



1 3 sizes – 1 coupler

MULTI/JOINT® 3000 Plus – saves costs → durable and corrosion resistant

The quality of the corrosion-resistant Resicoat® epoxy powder coating of the fitting body and the pressure ring, for which we undergo regular inspection as a GSK member, as well as the unique Uni/Fiks sealing system ensure a maintenance-free service life of 50 years under maximum working pressure. This enables secure and long-lasting repairs which are based on the working life of the water and gas pipeline network.

Across the total working life, 60% of the total operating costs can be saved compared to conventional long-range fittings.

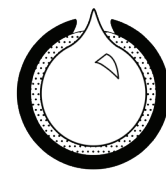

RAL GÜTEZEICHEN
SCHWERER KORROSIONSSCHUTZ
VON ARMATUREN UND FORMSTÜCKEN

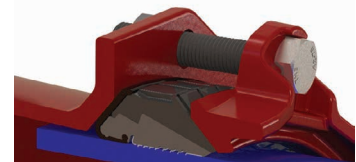

MULTI/JOINT® 3000 Plus – reliable and fit for purpose

The robust and practical light-weight design of the MULTI/JOINT® 3000 Plus fittings provides installers at the construction site with a large processing window. MULTI/JOINT® 3000 Plus enables angular pipe offsets up to a maximum of 8° per pipe side – thus maximum 16° per coupling – and nevertheless enables a reliable and secure joint across the lifespan.



MULTI/JOINT® 3000 Plus – fast, simple assembly

Simple access using standard tools, e.g. thanks to

- 1 Offset screw position.

Further advantages using MULTI/JOINT® 3000 Plus are

- 2 Simple and safe handling in the trench using a ring bolt DN200 – DN1025
- 3 Quick and easy assembly using transport clips (DN425 – DN600) or transport wedges (DN625 – DN1025), which hold the seal system to a maximum outside diameter during the push-over.

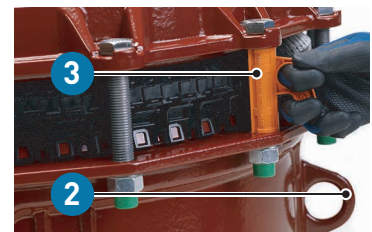

MULTI/JOINT® 3000 Plus – hygienic

The green PP hygiene protection, which is recyclable, safeguards the interior of the fitting from dust and dirt while it is being transported or stored.

The gasket and the media-guiding interior surface remain clean from production through to assembly and thus reduce the risk of your medium becoming contaminated.

Another advantage of the hygiene protection is that it makes the fittings stackable, thus saving valuable storage space.



ST system

The ST system comprises tailor-made, non-pull-out resistant compression fittings for all lines from DN40 to DN2200.

The jointing of the pipes therefore takes place through compression of the gasket. When the screws and nuts are tightened, the gasket is pressed onto the pipe surface via angular surfaces in the fitting and on the clamping ring.

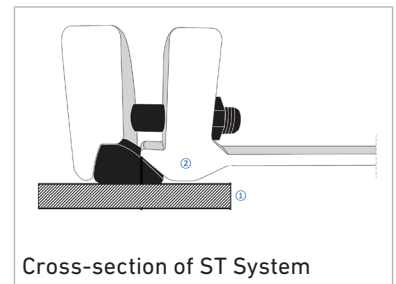

6.4 Flange connections

6.4.1 Functional principle

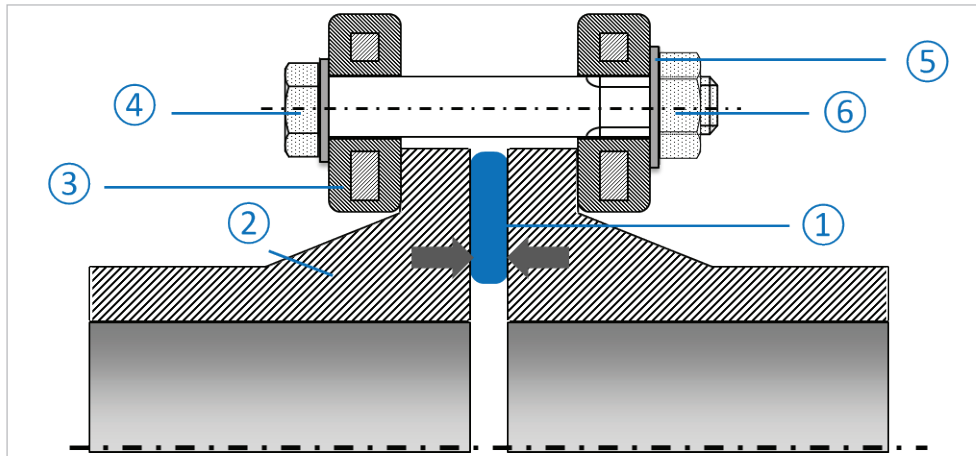

- 1 Gasket
- 2 Flange adapter
- 3 Backing flange
- 4 Screw
- 5 Washer
- 6 Nut

Flange connections between pipe ends are formed out of the components flange adapter 2, backing flange 3, and gasket 1, and screwed so that they are leakproof and pull-out resistant using screws 4, washers 5 and nuts 6. It should generally be ensured that the individual components are dimensionally coordinated with one another with regard to the medium, the working pressure, the service temperature and the soil conditions.

6.4.2 System components

Flange adapter

For the flange adapter, which is directly fused with the pipe, both short-legged models (for butt fusion only) and long-legged models (for electrofusion and butt fusion) are used.

Depending on the sealing type and application, various jointing faces are used for the flange adapter



Gasket

When selecting suitable flange seals for thermoplastic piping systems, the following factors must be taken into account:

- Operating conditions
- Sealing forces (or material pairing of the piping components)
- Gasket shape (shape of the jointing face on the flange adapter)
- Measurement (or type of backing flange)
- Material

Type of gasket

The following types are used as sealing shapes:

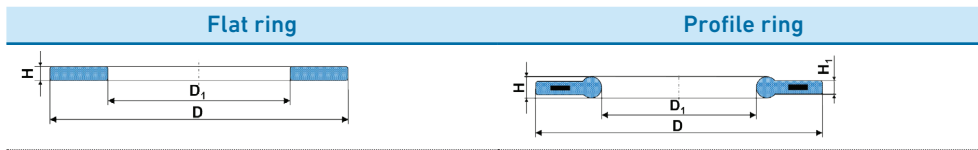

In applications with low working pressures, the customary flat gasket, which is made of 2 to 5 mm thick sheet material (depending on the nominal diameter), is sufficient. Flange connections with flat gaskets require flanges with sufficient stiffness. All flanges by GF Piping Systems meet these requirements.

For higher operating and testing pressures, profile flange gaskets have proven useful. Compared to flat rings, the profile ring consists of two parts: first, the flat gasket component, which also features a steel reinforcement, and second the profile seal part (O-ring, lip seal) on the inner side of the gasket.

Stabilized profile flange gaskets have the following advantages:

- Reliable seal with low bolt tightening torque
- Usable at higher internal pressures and internal vacuum
- Minor influence of flange or collar surface
- Operational safety in the jointing of pipes made of different materials

A suitable gasket form can be found using the table below.

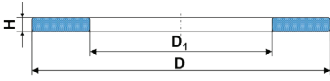
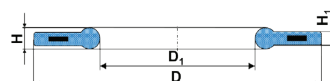
	Flat ring	Profile ring
		
Flange or collar design	With sealing grooves	With or without sealing grooves
Recommended pressure range	$P \leq 10$ bar, >DN200 only ≤ 6 bar	$P \leq 16$ bar, Vacuum ($p = 0$ bar)
Recommended temperature applied	$T_{max} 40$ °C	T = entire application area

In addition to the gasket form, the gasket materials and the hardness of the gasket are significant for the components used and for the type of application.

Gasket material

The choice of a gasket material is determined by the flow medium. Details about the suitability of the gasket material, or specifically its chemical resistance, can be found in the GF Piping Systems resistance tables.

The KTW policy (W270) for the DVGW stipulates EPDM gasket materials for drinking water applications. For gas, on the other hand, the DVGW demands an NBR rubber gasket in accordance with DIN 3535.

Gasket hardness

The use of hard material gaskets, such as those commonly used in steel pipelines, is not recommended for thermoplastic pipelines because the substantial sealing forces required cause distortion of the flange or collar. Elastomer materials, such as EPDM, NBR or FKM, with a Shore-A hardness of up to 75° are preferable.

Gasket measurements

The measurements of the gaskets are set out in the general standards for pipe jointing components.

GF universal gaskets: GF Piping Systems makes it easy for you to find the right gasket. These universal gaskets are perfectly suited to both butt fusion systems and socket fusion systems. Furthermore, they can be used regardless of the SDR level of your piping system (\geq DN200 no difference between PN10 and PN16 necessary).

The universal gasket is available as a profile flange seal and a flat gasket. The assembly is also simplified in that the universal gasket is centered over the bolt-hole circle.

Save time in selecting the right gasket, avoid mix-ups and reduce the ranges of gaskets in your warehouse.

Screws, nuts and washers

Here, too, for subterranean piping system construction, corrosion protection of components in the soil must be considered. To ensure free movement of the screws and nuts, PTFE coatings or approved lubricants (e.g. Klüber grease VR69-252) should be used.

In accordance with DIN EN ISO 7089, washers with a minimum hardness class of 200 HV should be used, as the hardness of the washer has a significant impact on the abrasion and therefore on the quality of the flange connection.

In practice, it is often difficult to specify the correct length of bolt for flange connections. It can be derived from the following parameters: The thickness of the washers (2×), thickness of the nuts (1×), thickness of the gasket (1×), flange thickness (2×), thickness of the flange collar (valve end or flange adapter) (2×), installation length of fitting, if available (1×). According to DVS 2210-1, you should dimension the necessary length of bolt for flange connections so that 2-3 turns of the thread protrude beyond the nut.

The online tool on the GF Piping Systems website allows you to select the optimal components for your perfect flange connection and also get information about the length of bolt and the tightening torque.

Backing flange

Backing flanges must be able to take up the tightening torque of the screws and also to transfer the resulting power to the flange adapter without distortion. Flanges therefore need to be very dimensionally stable! In subterranean piping system construction, plastic backing flanges (PP) can be used with a steel reinforcement or a corrosion protection-coated steel or stainless steel backing flange.

From a nominal diameter of DN200, the varying hole pattern for the different pressure levels (PN10 or PN16) should be taken account of, especially for backing flanges.









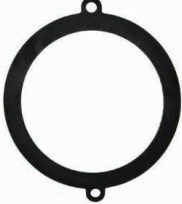

Comparison of various GF flange connection types

Flange type	Properties	Suitability	
		Inst.*	Medium**
PP-V flange	<ul style="list-style-type: none"> Corrosion-free all-plastic flange made of polypropylene PP-GF30 (fiberglass-reinforced) High chemical resistance (hydrolysis-resistant) Highest possible break resistance due to elasticity (deforms if it is tightened too much) Use for ambient temperatures up to 80 °C The temperature of the medium is restricted by the material of the plastic piping system UV-stabilized With integrated bolt-fixing Self-centering aid for the flanges on the flange adapter Symmetrical design allows assembly on either side: A "reverse" installation is never possible. All important information is readable. V-groove (patented) Even distribution of forces across the flange (protects components) Supports a longer-lasting torque for a safe joint 	O+	W/P
PP steel flange	<ul style="list-style-type: none"> Very robust and stiff due to steel reinforcement Corrosion-free plastic flange made of polypropylene PP-GF30 (fiberglass-reinforced) with steel reinforcement High chemical resistance (hydrolysis-resistant) Maximum ambient temperature 80 °C UV-stabilized 	O+E+	G/W/P
Steel flange, galvanized	<ul style="list-style-type: none"> Extremely robust and rigid 	O E	G/W/P
Blind flange	<ul style="list-style-type: none"> Combination of a backing flange and a PE 100 end blank. d63 to d315: End blank with backing flange PP-V. d355 to d630: End blank with PP steel backing flange. With the blanking flange set, the piping system can be closed off using the same material. If the piping system is extended, the backing flange can be used again, cutting down on additional costs. Suitable for pressure piping Easy assembly of the blank flange set: The end blank is centered on the inner diameter of the backing flange. 	Depending on backing flange	G/W/P

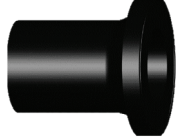
* Suitability for the installation environment:
O = above-ground,
E = subterranean,
+ = corrosive soils, environment

** Suitability of medium:
G = Gas,
W = water applications,
P = Industry

System overview

Flange seal		Blind flange	
	<p>Profile flange gasket NBR and EPDM d20/DN15 to d400/DN400 PN16 d450/DN450 to d630/DN600 PN10d710/DN700 to d1000/DN1000 PN6</p>		<p>Blind flange set PE d63/DN50 to d400/DN400 PN16 d450/DN500 to d630/DN600 PN10</p>
	<p>Flat gasket d20/DN15 to d180/DN150 PN10 d200/DN200 to d315/DN300 PN6</p>		<p>End blank PE d63/DN50 to d630/DN600 PN16</p>
Flange adapter		Backing flange	
	<p>PE 100 SDR11 PN16 d20/DN15 to d800/DN800 flat and serrated</p>	<p>PP-V </p>	<p>Hole circle PN10 d20/DN15 to d225/DN200 PN16 d250/DN250 to d400/DN400 PN10</p>
	<p>for butt fusion and electrofusion</p> <p>PE 100 SDR17 PN10 d50/DN40 to d1000/DN1000 flat and serrated</p>	<p>PP steel </p>	<p>Hole circle PN10 d20/DN15 to d400/DN400 PN16 d450/DN450 to d630/DN600 PN10 d710/DN700 to d900/DN900 PN6</p> <p>Hole circle PN16 d200/DN200 to d400/DN400 PN16</p>
Flange adapter		Backing flange	
	<p>PE 100 SDR11 PN16 d20/DN15 to d800/DN800* flat and serrated</p>	<p>Profile backing flange** </p>	<p>Hole circle PN10 d710/DN700 to d1000/DN1000 PN6 D1200/DN1200 PN4</p> <p>Hole circle PN16 d450/DN450 to d630/DN600 PN10</p>
	<p>only for butt fusion jointing</p> <p>PE 100 SDR17 PN10 d50/DN40 to d1200/DN1200 flat and serrated</p>	<p>Steel flange*** </p>	<p>Hole circle PN10 d200/DN200 to d630/DN600</p> <p>Hole circle PN16 d32/DN20 to d500/DN500</p>

- * Adaptor for butterfly valve can also be used as flange adapter
- ** Hole circle PN10: PP steel; hole circle PN16: Metal (epoxy coated)
- *** Material: S235JR/galvanized

System advantages

GF universal gasket – quick and easy

GF Piping Systems makes it easy for you to find the right gasket. Our universal gasket is perfectly suited to both butt fusion and socket fusion systems. They are also dependent on which SDR your piping system has. Save time when choosing the right gasket. Avoid mix-ups and reduce the ranges of gaskets in your warehouse. You can't go wrong with the universal gasket, available as a profile flange seal or flat gasket:

Just three steps to the right gasket

- Select gasket type
- Select dimensions
- Select material



GF flange connections – economical

All single components of a flange connection from Georg Fischer are coordinated with one another. You save time and money in the selection process and can be confident of a durable joint.



GF backing flange – secure and reliable

PP-V full plastic backing flange and PP flange with steel reinforcement from GF Piping Systems have chemical resistance even under aggressive installation conditions – corrosive soils or media/installation environment – and thus guarantee the safety and reliability of your piping system.

The integrated screw fixing and the flange's centering aid on the flange adapter makes assembly easier for you and saves you time. Screws falling out are a thing of the past.

The patented V-groove enables an even distribution of forces and supports long-lasting torque for a safe and reliable flange connection.

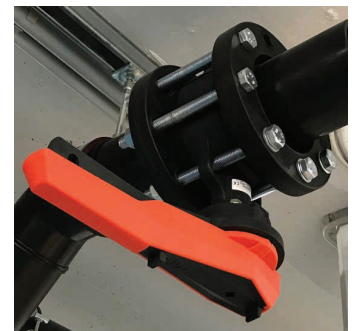

6.5 Multi/clamp

The stainless steel repair saddles consist of one or more saddle parts 1 and a rubber seal 2, which are strapped around the pipe with a defined torque using threaded bolts 3 and nuts 4 to plug leaks.

The flexibility of the saddle parts allows the multi/clamp repair saddles to be applied to pipe diameters ranging from 15 mm to 1000 mm.

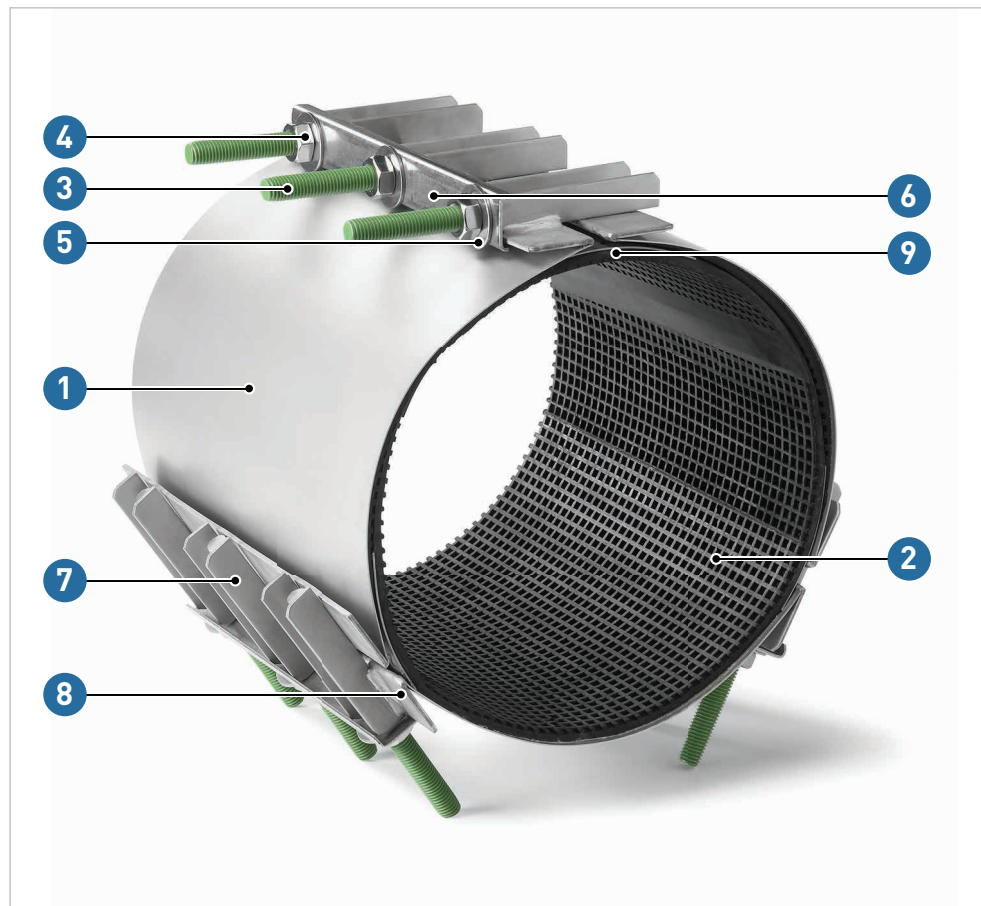

- 1 VA strap
- 2 Gasket
- 3 Threaded bolt
- 4 Nut
- 5 Washer
- 6 Retaining saddle
- 7 Screw cover
- 8 Side saddle
- 9 Guide plate

6.6 UNI-Coupling – repair couplings

Functional principle

UNI-Couplings are very easy-to-assemble stainless steel pipe couplings which are available in pull-out resistant and non-pull-out resistant models.

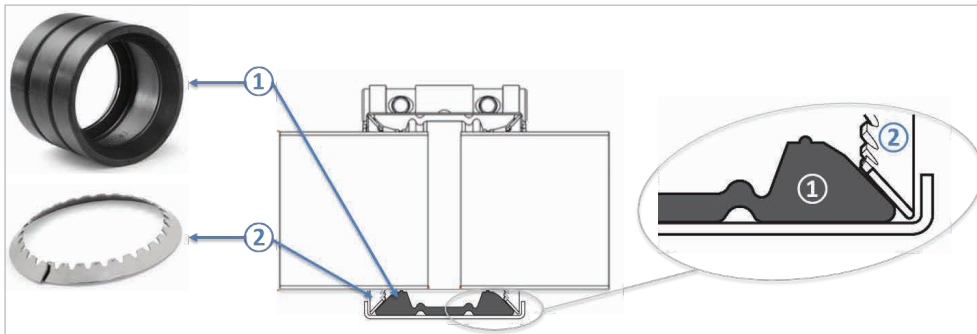

1 Gasket

The patented sealing solution with integrated compensator: Where a UNI-Coupling is used, the compensator beads mean that most applications no longer require any steel band reinforcement, reducing the risk of corrosion to a minimum. The wedge-shaped setup of the sealing geometry generates a dynamic sealing effect to achieve a perfect seal. Combined with the sound seal design without thin-walled lip constructions, a reliable pipe joint is guaranteed even in rough environmental conditions.

2 Anchoring ring

The tensile stress of the pipes being jointed, caused by internal pressure or external tensile forces, is safely absorbed by the progressively acting anchoring rings. The teeth exhibit a high hardness on the tooth tip caused by the ball impression on the back, which ensures a secure engagement even on hard pipe materials. This is particularly important for thin-walled stainless steel pipes and cast iron pipes. The simultaneous cut of the teeth (5°) will also achieve very good engagement behavior even for metallic-coated pipes as the coatings are penetrated and the anchoring effect takes place in the base pipe.

System components

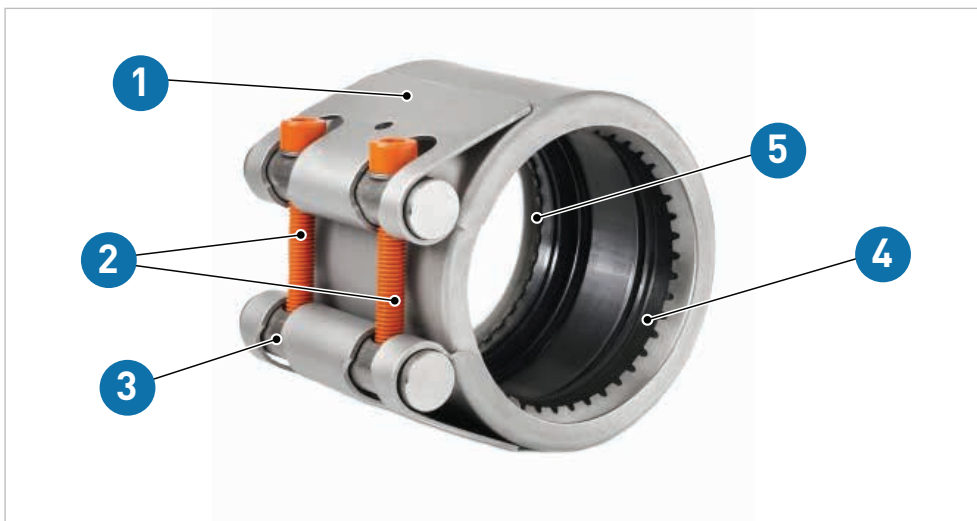

- 1 Housing
- 2 Screws
- 3 Bolt
- 4 Anchoring ring
- 5 Gasket

UNI-Coupling system overview

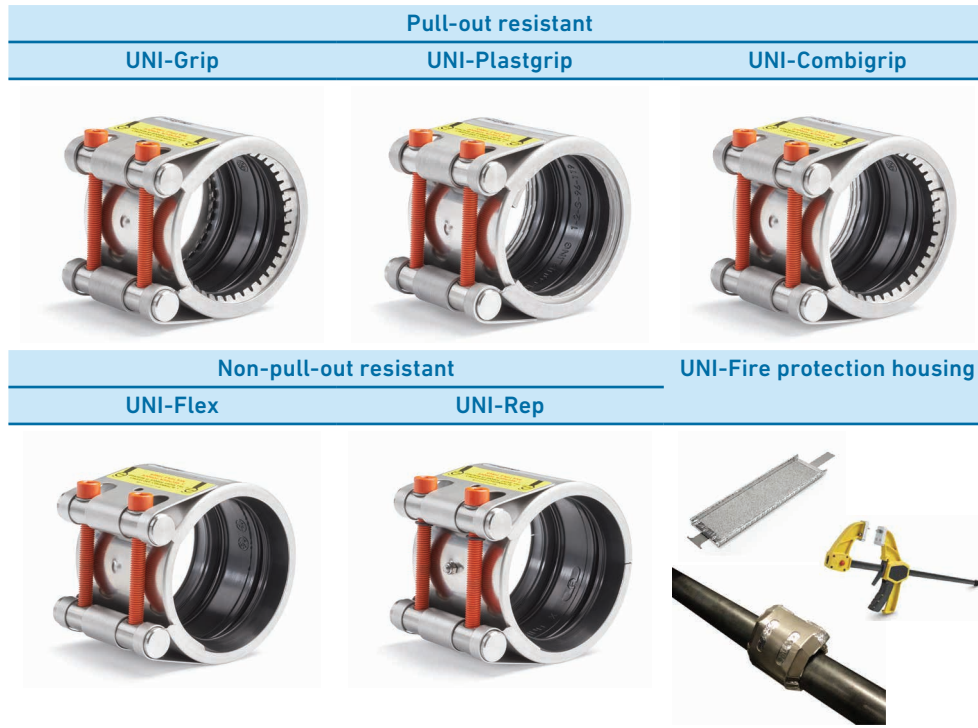

UNI-Coupling system advantages

UNI-Coupling – secure and reliable

- 1 The compensatory property of the patented sealing ring means that the UNI-Coupling does not require an additional strip insert made of metal or plastic on the inside of the coupling. The perfect sealing geometry guarantees freedom from leaks with thrusts up to 16 bar/ water.
- 2 The unique UNI-Coupling anchoring ring has a special skew-tooth profile with ball hardening, which provides a particularly good hold on the pipeline, in particular for hard surfaces such as thin-walled stainless steel and cast iron. Higher working pressure fixes the anchoring ring more tightly onto the surface of the pipe. This results in pull-out resistant jointing with a reliable and secure hold!
- 3 This means:
 - Clamp-free and flexible pipe jointing.
 - Compensates for axial movements and misalignments.
 - Pressure-resistant and leakproof, even when installation is not precise.
 - Very good cushioning of structure-borne sound, vibration and hydraulic shocks.



UNI-Coupling – durable

UNI-Coupling pipe couplings are made of high-quality materials. The housing consists of corrosion-free 1.4571 (W5) stainless steel, while the gasket is made of high-quality elastomers (EPDM/NBR), which ensures a long working life.

This guarantees:

- Corrosion and temperature resistance
- Good chemical resistance
- Long working life

No corrosion after 264 hours (11 days) Corrosion test in accordance with DIN EN ISO 9227



UNI-Coupling – saves costs → less storage

The larger UNI-Coupling clamping range enables it to cover large pipe dimension ranges with few couplings. This saves up to 30 % of warehousing costs. Efficient and economical in every way.

UNI-Coupling – saves costs → fast and easy installation

UNI-Couplings allow angle deviations of up to 5° in any possible pipe direction. The coupling can therefore be installed easily in locations with limited space. All that's required to assemble the coupling is the tightening of two screws!

The easy handling results in:

- No costly tools needed.
- Can be disassembled and re-used.
- Maintenance-free and straightforward handling.
- No heat or fire risk during installation.
- Premounted coupling for simple and quick assembly.
- Insertion of cut pipes without costly pipe end processing.
- No time-consuming alignment and installation work.

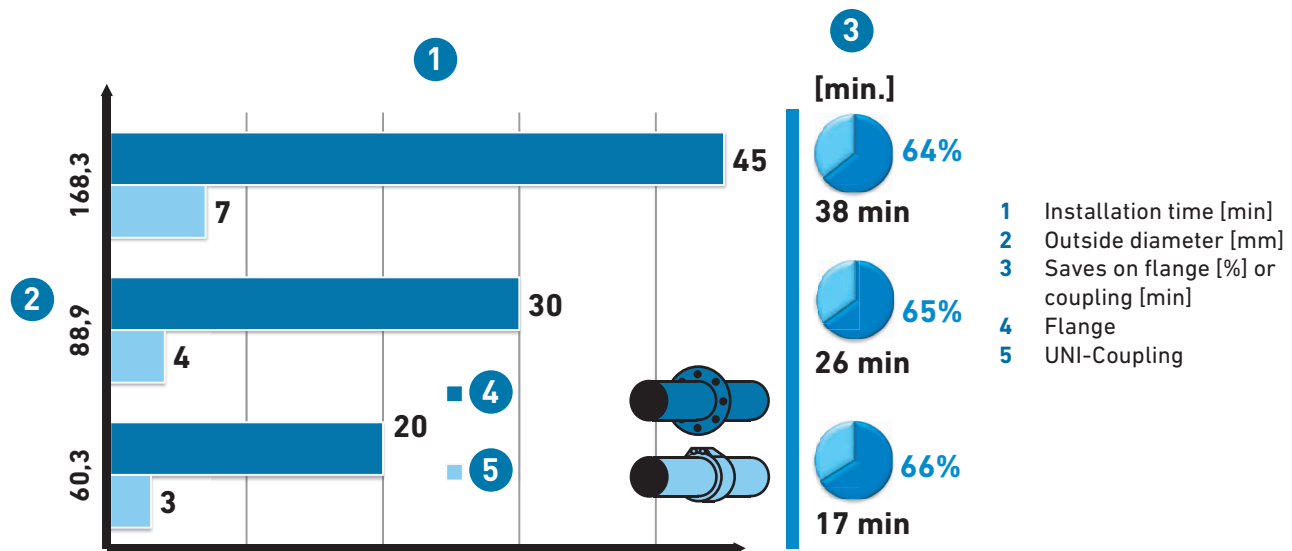

UNI-Coupling – universally applicable

UNI-Coupling is characterized by its flexible and universal application options:

- Use on thick and thin-walled pipes possible.
- Can be used on any pipe material.
- Compatible with all conventional pipe jointing systems.
- Connects the same or even different pipe materials.
- Seals joints regardless of medium, liquid or gaseous.
- Fast and quick service of pipe damage without loss of time.
- The same sealing and assembly principles as for all connections.
- Available as an axial restraint or as a non-restraint (compensator) version.

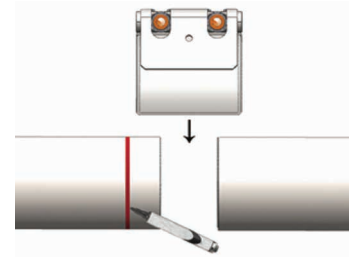
**UNI-Coupling – cushioning and flame-retardant**

UNI-Coupling also meets the highest requirements in shipbuilding and in industrial applications:

- 1 Oscillation curbing property of UNI-Coupling:**
 - Absorbs vibrations and oscillating movements.
 - Reduces water hammers.
 - Reduces fatigue failures.
 - Good structure-borne sound cushioning.
 - No fire or explosion risk during assembly.
 - No costs for additional protective measures.
 - Four times safer.
 - Absorbs overload thanks to flexibility.
- 2 UNI-Coupling is flame-retardant and fulfills the highest requirements, e.g. in shipbuilding. It is certified according to ISO 19921/19922.**

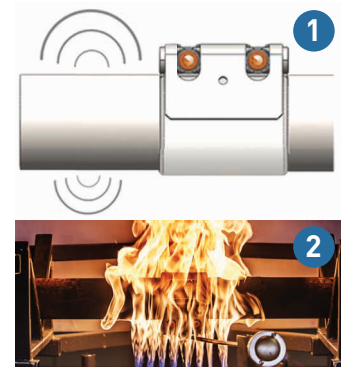
**UNI-Coupling – space-saving and lightweight**

- 1 The compact design allows UNI-Couplings to be laid in a space-saving way under restricted conditions. Only very little space is required for assembly. This enables lean insulation and small openings.**
- 2 A very lightweight jointing technology allows the actual payload of the pipeline's fixing to be increased.**

Weight comparison PN16; Ø114.3 (DN80)



6.7 PRIMOFIT compression joints

6.7.1 Functional principle and system components

PRIMOFIT is a compression joint that offers full end load capability made of malleable cast iron for the mechanical jointing of pipes made of steel, polyethylene and lead.

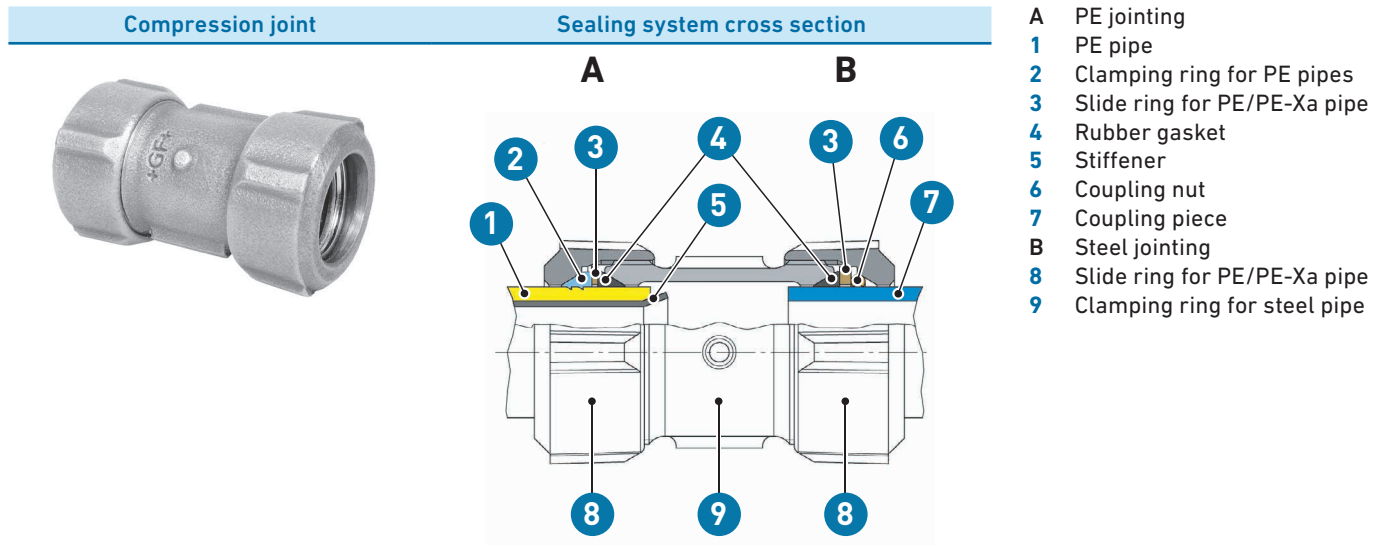











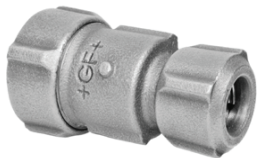

In the ready-to-install, pre-assembled state of PRIMOFIT compression joints, the inner diameter of the gasket, washer and clamping ring are bigger than the maximum pipe outer diameter. Tightening of the coupling nut causes the gasket to be pressed against the jointing face of the conical sealing chamber and the outer surface of the pipe. At the same time, a clamping effect is applied by the clamping ring, which enables full end load resistance.

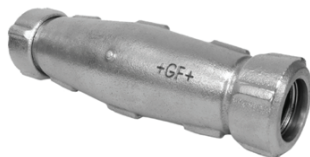
For connecting PE and PE-Xa pipes, an insert stiffener designed to fit into the pipe inner diameter is required, which increases the resistance of the PE/PE-Xa pipe to the radial forces.

6.7.2 Overview

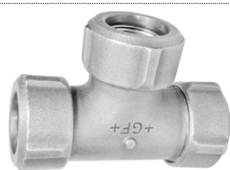
The complete assortment is available in black and galvanized.

Couplings		Transition connections	
	Short coupling, equal 3/8" to 3"		Transition coupling male thread 3/8" to 3"
	Short coupling, equal 4"		Transition coupling male thread 4"
	Short coupling, reduced 1/2" to 2"		Transition coupling internal thread 3/8" to 3"
			4"
	Long coupling, equal 1" to 2"		Long transition piece with internal thread 1/2" to 1 1/4"
			Transition piece with male thread, stainless steel 1/2" to 2"
Fittings		Transition moldings	
	Angle 90°, equal 3/8" to 2"		Angle 90° with internal thread 3/4" to 1"
	T piece 90°, equal 3/8" to 2"		
	Cap 3/8" to 2"		T 90° with internal thread 3/8" to 2"

PRIMOFIT system advantages

PRIMOFIT – simple and quick

PRIMOFIT compression joints are premounted ready for installation without prior disassembly of components. This means that no loose components can get lost or soiled on the construction site.



PRIMOFIT – secure and reliable

Thanks to the high quality choice of material (white malleable cast iron with hot-dip galvanization) and the unique clamping/sealing system, PRIMOFIT has been used for decades as a secure and reliable compression joint in a huge variety of applications worldwide.



PRIMOFIT – economical

The simple assembly of PRIMOFIT requires no thread cutting and minimal pipe end processing. No special tools or electrical power are required for assembly.

Furthermore, the use of sealing sets enables a very flexible application and the re-use of products.

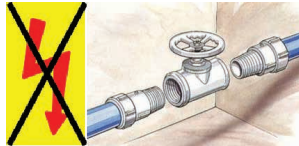

PRIMOFIT – hygienic

All PRIMOFIT compression joints are individually packed in PE bags. This ensures that the gasket and the inside of the fitting is protected against dust and soiling in the warehouse. Proper storage ensures that nothing will stand in the way of hygienic use in drinking water applications.



PRIMOFIT – simple

The color-coded bag packaging and assembly instructions as well as the EAN code enables a fast and simple way to identify products in the warehouse and on the construction site.



In addition, <https://www.fittings.at> or the QR code gives online access to the installation video.



6.8 iJOINT – compression joints

Functional principle and system components

Compared to conventional compression joints, iJOINT scores points for its faster and simpler assembly.

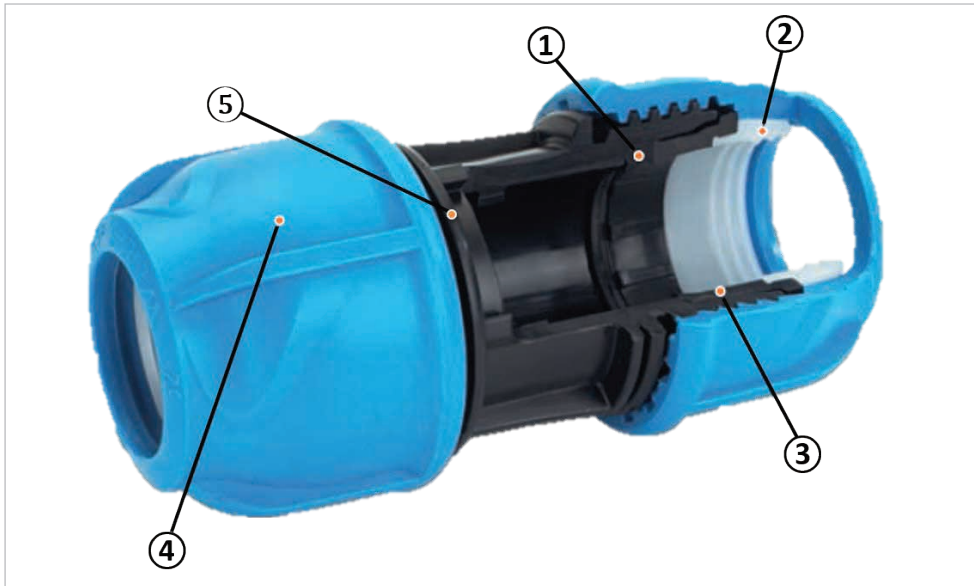

1 Lip seal

The special NBR lip seal ring is equipped with lubricant at the factory. This allows the pipe to be inserted seamlessly and evenly. The special lip gasket offers an exceptional seal, even for oval and scratched pipes.

2 Clamp ring

The clamping ring firmly clamps the pipe and guarantees a very high tensile strength.

3 Backing ring

The backing ring compresses the lip seal ring, whereby this is pressed against the pipe and ensures an optimal hydraulic seal.

4 Coupling nut

The coupling nut presses directly onto the backing ring and compresses the gasket for an optimal seal. The ergonomic, light-weight design of the coupling nut enables simple handling during tightening.

5 Stop washer

Reaching the stop washer activates an unscrewing lock which prevents any unwanted untightening – including in critical applications (reaching the stop washer might not always be possible depending on the pipe dimensions and the construction site conditions.)

iJOINT system overview

Couplings		Transition couplings	
	Coupling, equal d16 to d110		Transition coupling, male thread d16-1/2" to d110-4"
	Repair coupling d20 to d110 (without center stop)		Transition coupling, internal thread d16-1/2" to d110-4"
	Coupling reduced d25-20 to d110-90		Transition coupling, metal (brass), male thread d20-1/2" to d63-2"
-	-		Transition coupling, metal (brass), internal thread d20-1/2" to d63-2"
Fittings		Transition moldings	
	Angle 90°, equal d16 to d110		Transition angle 90°, male thread d16-1/2" to d110-4"
	Angle 45°, equal d20 to d63		Transition angle 90°, internal thread d20-1/2" to d110-4"
	T 90° equal d16 to d110		Transition angle 45°, male thread d20-1/2" to d63-2"
	T 90° reducing d25-20 to d110-90		Transition T 90°, male thread d20-1/2" to d110-4"
	Endpiece d16 to d110		Transition T 90°, internal thread d20-1/2" to d110-4"
	Screw connection with flange (F-piece) d50-1/2" to d110-4"		Transition angle 90°, metal (brass), male thread d20-1/2" to d32-1"

iJOINT system advantages

iJOINT – simple and quick

iJOINT compression fittings are immediately ready for installation to plug into the pipe, without prior disassembly of the components or chamfering of the pipe. This means that no loose components can get lost or soiled on the construction site.

iJOINT compression fittings are already jointed after just a few turns. The highest extraction forces achievable by hand are up to d32 and ≥ d40 using the mounting key.

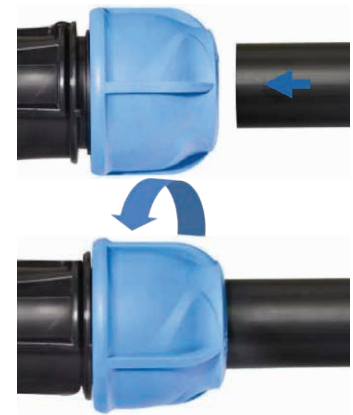

iJOINT – secure and reliable

The patented light-weight design of the iJOINT compression fittings guarantees the utmost reliability of the sealing effect even for oval or scratched pipes, as well as maximum hydraulic safety. The highest extraction forces for iJOINT exceed the KIWA requirements by more than 100 %.

Reaching the stop screw ① activates an unscrewing lock which prevents any unwanted untightening.

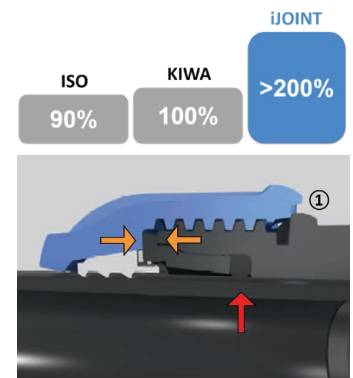

iJOINT – economical

Without chamfering and disassembly, the ready-for-installation iJOINT compression fittings are installed twice as quickly as conventional compression joints on average.

- 1 Assembly time savings
- 2 Conventional compression joints
- 3 Installation time [s]
- 4 Example d32

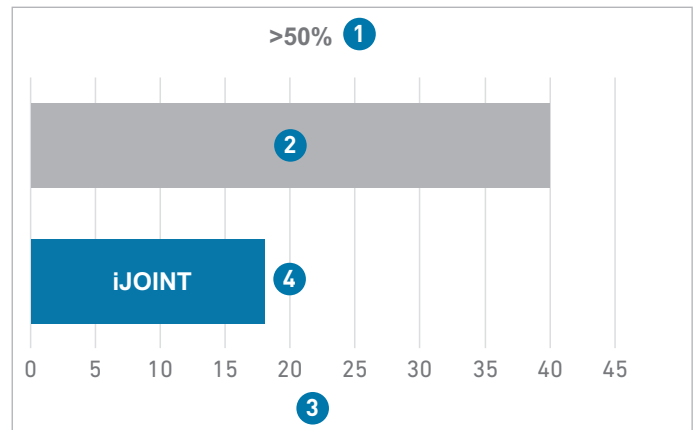

iJOINT – hygienic

All iJOINT compression fittings up to d32 are packed in PE bags (each with 10 pieces). Larger fittings are packed in cardboard boxes. This ensures that the gasket and the inside of the fitting are protected against dust and soiling in the warehouse. Proper storage ensures that nothing will stand in the way of hygienic use in drinking water applications.



iJOINT – simple

The bag packaging enables a fast way to identify products in the warehouse and on the construction site.

In addition, the QR Code on the packaging gives fast and simple online access to the installation instructions and installation video.

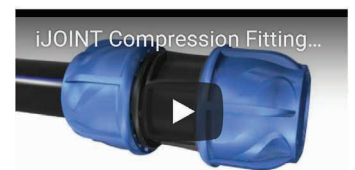

6.9 PP saddles

The PP compression saddles represent a functional extension to the assortment of iJOINT compression fittings for the creation of side branches and hookups.

System overview of mechanical saddles

Branch saddle	Tapping saddle
 <p data-bbox="477 468 695 524">Branch saddle, blue (Type 654)</p> <p data-bbox="491 555 683 582">d20-½" to d315-4"</p> <p data-bbox="429 613 746 640">PN16: d20-160PN10: d180-315</p>	 <p data-bbox="1174 468 1445 524">Universal tapping saddle For PE/PVC pipes</p> <p data-bbox="1211 555 1409 582">d50-20 to d160-63</p> <p data-bbox="1281 613 1339 640">PN16</p>

iJOINT saddle system advantages

iJOINT saddles – simple and quick

Type 654 branch saddles and type 684 tapping saddles are simple and easy for one person to install quickly.

- The fixing in the base part stops the screws from falling out during assembly.
- Prefixing the base part onto the main pipe makes the assembly of the top part easier.

Special grooves in the base part prevent unwanted tilting/twisting of the saddle during assembly onto the pipe.



iJOINT – secure and reliable

The specially developed profile seal offers greater safety for

- Hydraulic shocks
- Oval and scratched pipes

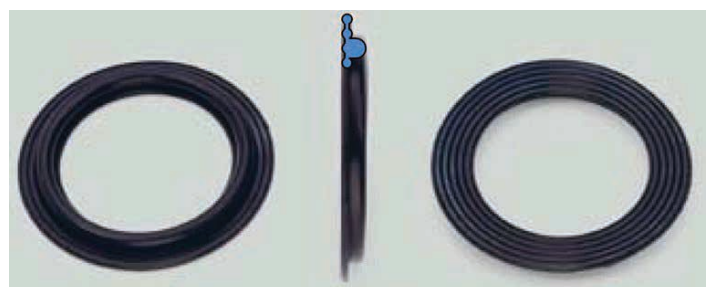

System components

Content

1	The ELGEF Plus electrofusion system	137
1.1	Quality	137
1.2	Application range	138
1.3	Identification	139
1.4	CAD library	142
2	Couplers and fittings	143
2.1	System advantages of ELGEF Plus couplers	143
2.2	System advantages of ELGEF Plus fittings	144
2.3	System advantages of ELGEF Plus transition adaptors	145
3	Saddles and pressure tapping valves (PTVs)	146
3.1	System advantages of ELGEF Plus saddles	146
3.2	System advantages of tools: tapping saddles	148
3.3	Stop-off adaptors	149
3.4	Spigots with drilling cutter	149
3.5	Excess flow valves	149
3.6	ELGEF Plus Y-tapping saddle d180 – d315	149
4	Spigot fittings	150
4.1	System advantages of ELGEF Plus spigot fittings	150

5	Valves for applications in the utility segment	151
5.1	System advantages for plastic valves in the utility segment.....	151
5.2	ELGEF Plus pressure tapping valve	151
5.3	ELGEF Plus ball valve.....	152
5.4	NeoFlow pressure regulating valve	154
6	Electrofusion units.....	156
6.1	Overview of electrofusion units	156
6.2	Installation guidelines – fault prevention	157
6.3	Butt fusion machines	159
7	Tools and accessories for electrofusion.....	162
7.1	Overview.....	162
7.2	Tools and aids.....	165
7.3	Maintenance and rental	170

1 The ELGEF Plus electrofusion system

ELGEF stands for „Elektroschweissen Georg Fischer“ and has been the brand name of the GF electrofusion system for over 30 years now. The system consists of electrofusion fittings and saddles as well as PE ball valves and spigot fittings.



1.1 Quality

ELGEF Plus products undergo strict quality control as defined in the internal quality plan. This quality is checked and confirmed by means of internal and external audits.

The quality plan defines the procedure, the means and the chronological sequences necessary to verify and document the specified quality targets for the ELGEF Plus products. ISO10005 and the approvals and standards listed in Chapter 3 serve as the specification.

Correlation and chronological sequence of the TT/AT/BRT/PVT tests

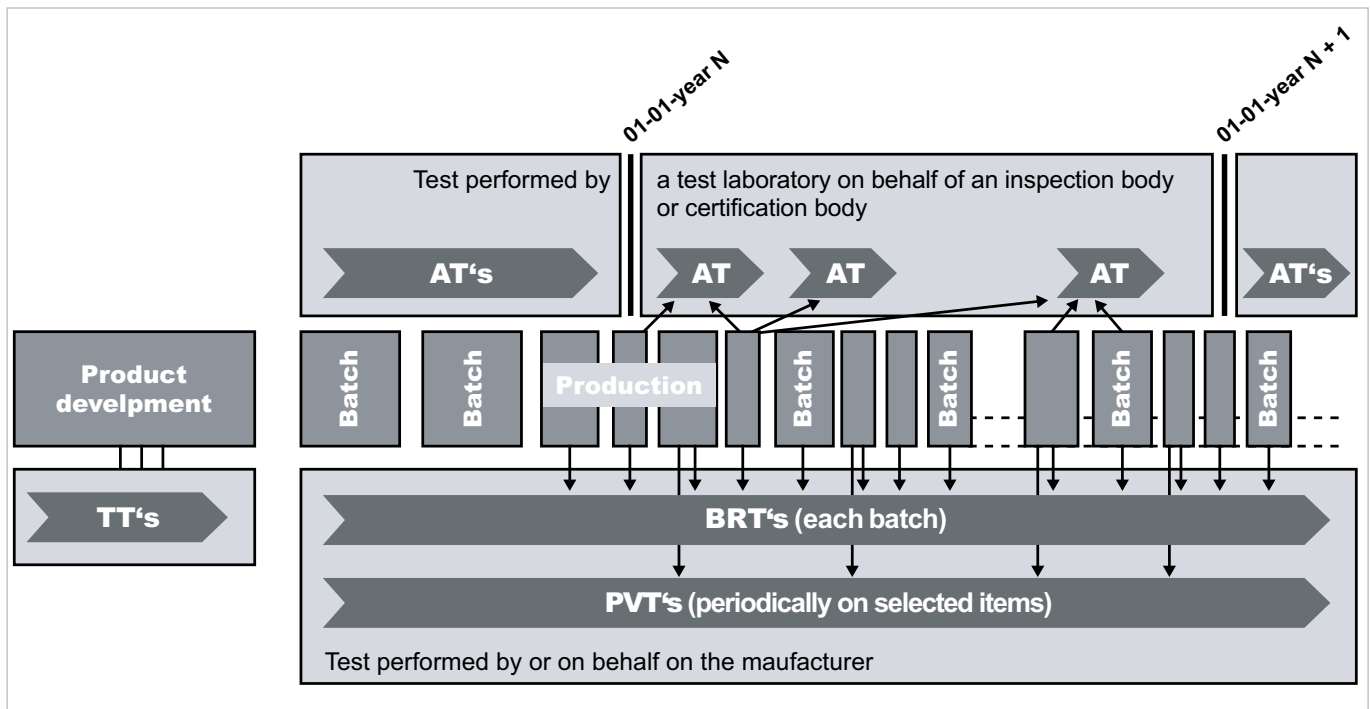

- TT** Type Test; a test performed in order to prove that the material or the parts meet the requirements listed in the relevant standards.
- AT** Audit Test; a test performed by or on behalf of a certification body.
- BRT** Batch Release Test
- PVT** Process Verification Test; the planned random sampling of parts and materials in order to verify the process continuity.

1.2 Application range

ELGEF Plus electrofusion and spigot fittings are developed, approved, manufactured and monitored according to the applicable standards EN 12201, ISO 4427 (water), EN 1555, ISO 4437 (gas), EN ISO 15494 (industrial application) as well as other local standards.

Suitable pipes

ELGEF Plus electrofusion and spigot fittings are suitable for welding of PE standard pipes made of PE 63, PE 80, PE 100 and PE 100-RC whose melt flow rate (MFR) is between 0.2 and 1.4 g/10 min and corresponds with the common pipe standards EN12201-2, EN 1555-2, DIN 8074/75, ISO 4427-2 and ISO 4437-2. The restricted diameter tolerance class B and the upper limit dimension of ovality are recommended for straight lengths. Separate product-specific or manufacturer-specific approvals apply for PE-X pipes.

For pipes with a minimum wall thickness $s_{\min} \geq 3.0$ mm, ELGEF Plus electrofusion fittings can generally be fused in the following SDR and dimension range:

- d20 – d800 mm SDR 11
- d90 – d1200 mm SDR 17/17.6

ELGEF Plus fittings can also be welded compatibly with other SDR classes. The permissible SDR range is shown on the bar code attached to the fitting and must be confirmed by the responsible GF branch in case of doubt.

When different SDR classes are used in one system, the highest SDR level determines the maximum working pressure.

Ambient temperature

Processing of ELGEF Plus electrofusion fittings takes place using GF electrofusion units at ambient temperatures between -10 °C and +45 °C. The measures described in DVS 2207-1 must be taken in the case of adverse weather conditions (rain, frost, exposure to the sun, etc.).

Examples: Protection from adverse weather conditions



Protecting the welding zone using a tent



Water residues must be pumped off

Maximum working pressure

After assembly in a piping system, ELGEF Plus electrofusion and spigot fittings are exclusively intended for allowing media such as gas or water to flow through the pipe within the permissible pressure and temperature limits or for controlling this flow.

	Water (20 °C)	Gas (20 °C)
PE 100	Max. working pressure for C = 1.25 PFA [bar]	Max. working pressure for C = 2.0 MOP [bar]
SDR11	16	10*
SDR17	10	5*

* Deviations in accordance with national directives (e.g. CH), or note product-specific restrictions!

PFA Maximum permissible working pressure for water

MOP Maximum permissible working pressure for gas

1.3 Identification

1.3.1 Batch no. (production batch)

Important information on logistics (article no./EAN code/batch/weight), applicability (standards/approvals/application) and simplified installation (online operating manual/manual fusion data) can be found on the bag or box packaging. The batch no. (production batch) is also permanently molded into the product in the form of a series marking, providing information on production year and production batch.



22 Year of production
1 Batch no.

Here: Batch no. 2201
Meaning: First production batch
produced in 2022

1.3.2 Welding data and traceability

Fusion data

There are various different ways of transmitting the fusion data to the fusion device. The most widespread (and recommended) method is by scanning a welding bar code. The contents of this welding bar code are described in the standard ISO 13950. Scanning the welding bar code avoids input errors. The fusion parameters are automatically transmitted to the fusion device. In addition, the fusion data is made available in the form of a 2D data matrix code according to ISO 12176-5.

If it is not possible to log the fusion data automatically by means of the fusion bar codes or 2D data matrix codes, the fusion data can be entered manually.

Temperature-compensated fusion times

All ELGEF Plus electrofusion fittings have a bar code which automatically adapts the fusion time to the ambient temperature of the fusion device. Electrofusion fitting, pipe and fusion device have to be on the same temperature level before welding begins. Please note the time necessary for adapting the temperature!

Traceability

Continuous traceability safeguards the operation of the piping system. For each component, the entire processing chain can be traced back to the production of the raw materials.

The system of traceability is described in the standard ISO 12176, Part 4.

Besides the welding bar code, the sticker attached to the ELGEF Plus electrofusion fitting also includes the traceability bar code. The information on the cooling time and the applicability of the permissible SDR classes of the pipe complete the fusion data. In addition, the manual fusion data in various temperature ranges is displayed on the bag label.

Documentation

The documentation of the work procedure for pipe installations is becoming more and more important. The WeldinOne software assists you here in welding or system maintenance. The Welding Book software extends the data about the joint beyond the fusion protocols gathered by the electrofusion and butt fusion machines. The software automatically combines images made using any smartphone camera with the respective fusion protocols in order to document all preparatory activities such as peeling and using clamp holders as well as using the correct fittings and pipes. The Barcode Creator helps you to create the Operator IDs for your fitters in accordance with their competences and the ISO 12176-3 standard. It creates the order number in a transparent way in order to trace the installation or the construction site and allows the automatic assignment of your joint to a certain code. The Barcode Creator creates certain codes for the tools used at the construction site and even for pipes (manufacturer, type, diameter and date of purchase).

1.4 CAD library

Product library of GF Piping Systems

With the CAD library, GF Piping Systems aims to provide planning engineers and designers with even better and more efficient support for the design of piping systems.

Three-dimensional models (3D models) of all piping components from GF Piping Systems can be found via the data base. The user applies these to create the two dimensional drawings (2D drawings) they need in the desired views.

The library works independently of the user's CAD system and supports a broad array of systems and interfaces.

The data base comprises over 30 000 drawings and technical data regarding pipes, fittings, measurement and control technology as well as manual and actuated valves.

The CAD library offers:

- Data packages with all the drawings of a system
- Over 30 000 drawings
- Pipes, fittings, valves, measurement and control technology
- Presentation in 2D and in 3D
- Optimized user interface
- Multifunctional drivers for the most common CAD systems
- Quick access

The screenshot shows the CAD library web interface. At the top, there are navigation tabs: CAD-Bibliothek, Downloadcenter, Datenpakete, Software, and Feedback. On the left, a 'Produktgruppen' tree is visible, with 'PE ELGEF Plus' expanded to show 'Anschlussattel Topload' and its sub-items: 'Abgang 90-125mm', 'Abgang 160-225mm', and 'Abgang 315-500 mm'. The main area displays a 3D model of a black fitting. To the right of the model, there are controls for '3D-Ausgabe' and '2D-Ausgabe', a dropdown for 'Format: Bitte wählen', and a 'Generieren' button. Below that, there is a 'Click2CAD - Direkt einfügen' section with a warning 'Nur für Internet Explorer mit aktivierter Java-Unterstützung.' and a 'CAD-System: Bitte wählen' dropdown with an 'Einfügen' button. At the bottom, a table shows the article number '193135264' and the article description 'Anschlussattel Topload, PE100'.

Sample presentation of the CAD library

■ Direct access to the online CAD library at <http://cad.georgfischer.com>



2 Couplers and fittings

2.1 System advantages of ELGEF Plus couplers

ELGEF Plus couplers d20 – d63 – integrated pipe fixation

ELGEF Plus electrofusion couplers d20 – d63 are equipped with an “integrated pipe fixation”.

This facilitates pipe installation for:

- Vertical pipe sections
- Preinstallation of fittings, metal adapters or valve modules
- For prefixing coiled pipe ends (does not replace the use of clamping devices)



ELGEF Plus couplers d20 – d160 – easy-to-remove center stop

All ELGEF Plus electrofusion couplers d20 – d160 are equipped with a removable center stop. This facilitates pipe installation:

- A limit stop can be felt when the pipe is inserted
- When the coupler is pushed over the pipe, the center stop can be “ejected” easily with the pipe



ELGEF Plus couplers – number of fusion zones

ELGEF Plus electrofusion couplers d20 – d500 have two interconnected (monofilar) fusion zones, i.e. both fusion zones are fused in one fusion process.

As a result of the necessary power input, two separate (bifilar) fusion zones are required for ELGEF Plus couplers \geq d560. This means that each pipe end can be fused separately using these electrofusion couplers.



ELGEF Plus couplers – simple assembly and easy to push over pipes

Thanks to the covered heating coils and the specially developed electrical design, all ELGEF Plus electrofusion couplers are able to bridge a relatively large gap. For this reason, the **couplers** have a larger internal diameter. This facilitates pipe installation:

- When the coupler is pushed onto the pipe end
- When the coupler is slid over the pipe, thus reducing the installation time



ELGEF Plus couplers d355 – d800 – active reinforcement

ELGEF Plus electrofusion couplers d355 – d800 are equipped with an “active reinforcement”. The outer PE ring expanded in the manufacturing process exerts its tension when heated during the fusion process and actively presses onto the internal ring during welding. This causes the gap between pipe and fitting to be closed actively and expansion of the coupler to be inhibited.

In other words:

- The couplers are easier to push over the pipe, thus facilitating assembly
- Reduced installation times are possible without preheating or additional equipment

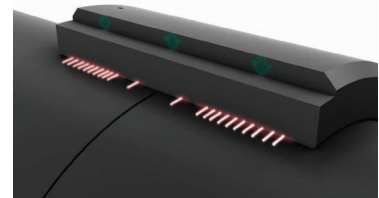

2.2 System advantages of ELGEF Plus fittings

ELGEF Plus fittings d20 – d63 – integrated pipe fixation

ELGEF Plus electrofusion moldings from d20 – d63 are equipped with “integrated pipe fixations”.

These facilitate pipe installation for:

- Vertical pipe sections
- Preinstallation of fittings, metal adapters or valve modules
- For prefixing coiled pipe ends (does not replace the use of clamping devices)



ELGEF Plus fittings – simple assembly and easy to push onto pipes

Thanks to the covered heating coils and the specially developed electrical design, all ELGEF Plus electrofusion fittings are able to bridge a relatively large gap. For this reason, the fittings have a larger internal diameter. This facilitates pipe installation when the fittings are pushed onto the pipe end and reduces the installation time.



ELGEF Plus moldings d75 – d250 – insertion depth marking

The ELGEF Plus electrofusion fittings d75 – d250 feature an insertion depth marking [1]. This facilitates the measurement of the welding zone length without the packaging of the fitting having to be opened at an early stage, allowing the fitting to become contaminated.

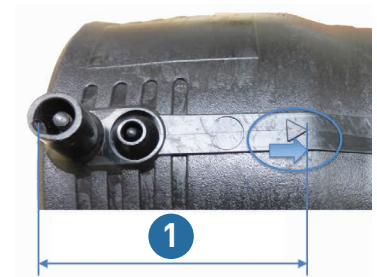

ELGEF Plus moldings d75 – d180 – elbow marking

There is an elbow marking around the fitting's couplers opening on ELGEF Plus electrofusion fittings d75 – d180. This facilitates the alignment of the fitting with regard to angle and position during installation without additional measuring equipment being required.



ELGEF Plus fittings – number of fusion zones

ELGEF Plus electrofusion fittings d20 – d180 have two interconnected (monofilar) fusion zones, i.e. both pipe ends are fused in one fusion process. To facilitate installation, ELGEF Plus fittings \geq d200 have two separate (bifilar) fusion zones. This means that, with these electrofusion fittings, each pipe end can be fused separately.



2.3 System advantages of ELGEF Plus transition adaptors

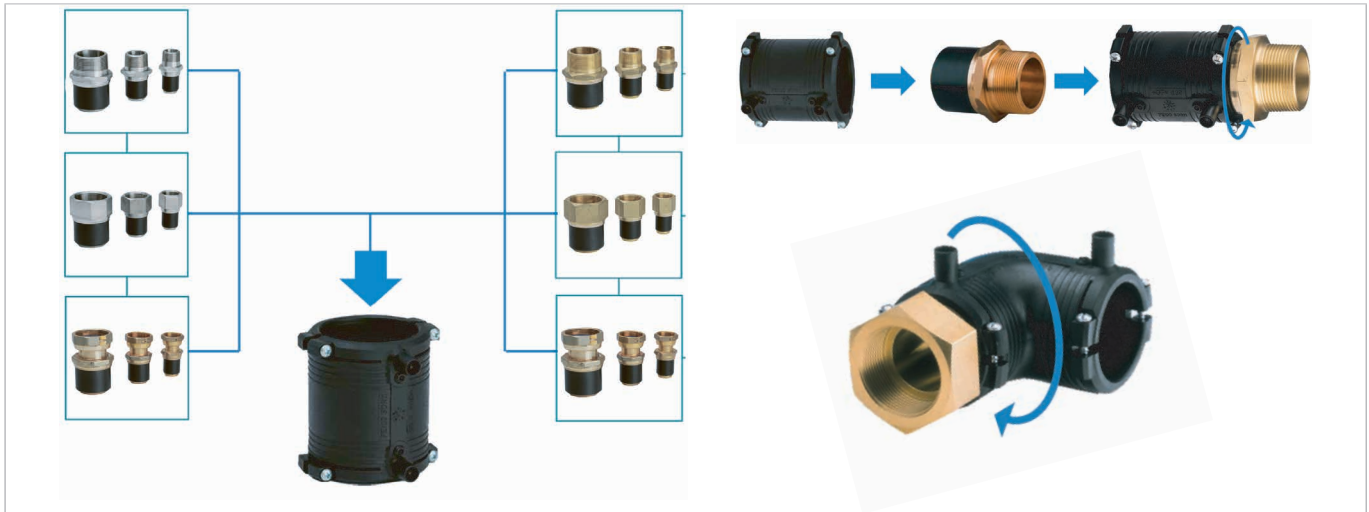

ELGEF Plus transition fittings d20 – d63 – modular system

ELGEF Plus electrofusion transition couplers and fittings d20 – d63 are structured as a modular system. A wide range of transition variants can be created from one coupler or fitting. This flexibility makes assembly easier and faster – and reduces your installation costs. These transition adaptors can only be used in conformity with the system – in connection with ELGEF Plus electrofusion fittings.

This increases your installation flexibility and reduces the necessary warehouse space:

- Complete system with few component parts
- Reduction of warehouse storage by up to 50 % in value terms
- Flexible assembly with valves thanks to the possibility of rotating and screwing the adaptor shortly before welding begins
- Materials approved for use with drinking water – optionally in brass or stainless steel

During laying, it should be noted that the piping must withstand mechanical stresses and the expected corrosive stresses coming from the outside. If necessary, the transition adaptors must be coated or covered. The existing soil conditions and the assembly and operating conditions are crucial for the selection of the pipe covering.

The outer coating or covering has to meet the various requirements in a suitable way as follows:

Excellent resistance against external influences after laying, such as aggressive soils, stray currents, microorganisms, plant growth etc.

3 Saddles and pressure tapping valves (PTVs)

3.1 System advantages of ELGEF Plus saddles

ELGEF Plus saddles d63 – d400 – modular system

ELGEF Plus electrofusion Duoblock saddles d63 – d400 are structured as a modular system. It is possible to create a wide range of saddle variants from one Duoblock saddle – such as tapping saddles, tapping saddle with a gas stop, PTVs, stop off saddles and spigot saddles with drilling cutter – for different outlet dimensions.

This system approach increases your installation flexibility and reduces the necessary warehouse space:

- Complete system with few component parts
- Reduction of warehouse storage by up to 50% in value terms
- Variable assembly possible as the outlet can be rotated by 360°
- Vertical or horizontal assembly possible

This flexibility makes assembly easier and faster – and reduces your installation costs. In the modular system, only additional components conforming to the system are permitted!



ELGEF Plus saddles d63 – d400 – large drilling diameter

ELGEF Plus electrofusion saddles have extra-large drilling diameters (**d2**). They also have considerably larger cross-sections than the usual commercially available products.

This causes a lower pressure loss and gives the operator the following advantages:

- More pressure arrives at the consumer at the same input pressure.
- The pressure in the supply pipe can be reduced.

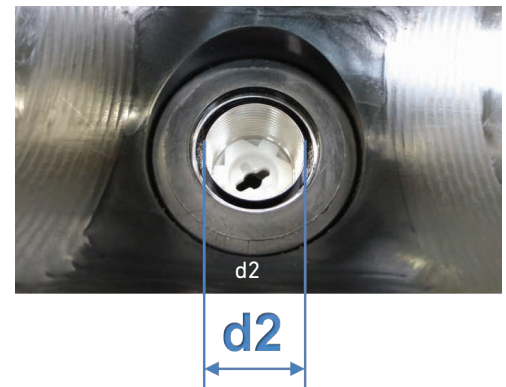

ELGEF Plus saddles – peeling of outlet spigot no longer needed

We place particular emphasis on cleanliness during production of the electrofusion fittings, and each fitting is packed “cleanly” in a bag. As a result, the spigots connecting to the electrofusion saddle or to the outlet pipe do not need to be peeled – on condition that they are used immediately upon removal from the protective bag:

- This saves valuable installation time.
- There are no expenses for special peeling tools for peeling the outlet spigots.

By reducing the costs of your building connection project, you enhance your competitiveness. However, if the outlet spigots are professionally peeled in a manner that results in chipping, this does not compromise their quality, and usability remains guaranteed. We recommend cleaning the outlet spigot using Tangit PE cleaner.



ELGEF Plus saddles – length of the outlet spigot

In the unfavorable event of an assembly fault, the length of the outlet spigot allows a second welding process to be carried out. The outlet spigot of the ELGEF Plus electrofusion saddles can be shortened in the case of an assembly or fusion fault, and the remaining length then allows the outlet to be refused*:

- Where necessary, this saves considerable installation time and reconditioning costs.
 - This saves you from trouble with residents and the network operator.
- * This does not apply when an integrated excess flow valve is used.

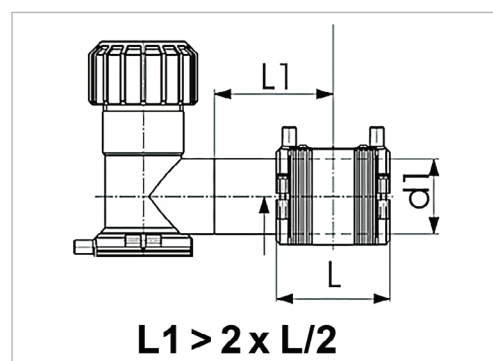
**ELGEF Plus branch saddles – efficient installation of reduced outlets**

ELGEF Plus branch fittings are an extremely reliable and hugely economical way of installing reduced outlets and offer you the following advantages when they are newly installed:

- Variable positioning on the main pipe
- 1 less weld compared to a T-piece
- For main pipelines d63 – d2000 with outlet solutions d63 – d500
- Full pressure class possible
- Considerably lower material costs
- Overall installation costs are reduced considerably as a result of the shorter installation time and the smaller size of the trench

When integrated later:

- Can be integrated under working pressure
- The usual commercial tapping methods can be used
- Smaller trench size in inner city areas
- Optimum alternative to the T-piece for new installation, later integration and renovation/repairs





3.2 System advantages of tools: tapping saddles

Article no.	Installation tools
799 198 047	Assembly and tapping key for saddles (external hex SW8, internal hex 10 and 17)
799 150 378	Hexagon spanner for saddles and branch saddles (external hex SW8)

Monoblock tapping saddles d40, d50

	d _n	Tapping key	Test cap	Tapping adaptor*
	40			Not required!
	50			

Tapping saddle monoblock version with molded-on base part

	d _n	Tapping key	Test cap	Tapping adaptor*
	63			Not required!
	90			
	110			
	125			
	160			

Y-tapping saddle

	d _n	Tapping key	Test cap	Tapping adaptor*
	180	799 198 047	799 199 290	Not required!
	200			
	225			
	250			
	280			
	315			

Duoblock tapping saddles with freely adjustable outlet

	d _n	Tapping key	Test cap	Tapping adaptor*
	63		S54 for outlet d20 – d40	S54 for outlet d20 – d40
	-			
	400		S67 for outlet d50 – d63	S67 for outlet d50 – d63
				

Pressure tapping valves (PTVs)

	dn	Tapping key	Test cap	Tapping adaptor*
	63	Ratchet External hex SW14	Not required!	Not required!
	-			
	400	13 revolutions Outlet d32		
		28 revolutions Outlet d63		

* Tapping with no gas losses

3.3 Stop-off adaptors

ELGEF Plus stop-off adaptors – the repair solution for shut off under gas pressure

For the short-term blocking of gas pipes while repairs are carried out, isolating bladders are often used in the low-pressure range. Using an ELGEF Plus stop-off adaptor and an ELGEF Plus saddle, the stop-off adaptor can be connected to the piping quickly and easily.

This increases your installation flexibility and reduces the necessary warehouse space:

- Complete system with few component parts
- Reduction of warehouse storage by up to 50 % in value terms



3.4 Spigots with drilling cutter

ELGEF Plus spigots with drilling cutter – a cost-efficient solution for new installations

A PE spigot with drilling cutter can also be integrated into the modular system of ELGEF Plus branch saddles:

- In case of doubt, this reduces the height of the pipe covering and
- Saves you money on the components



3.5 Excess flow valves

Excess flow valves are for emergency shut-off after damage or destruction of branch pipes and prevent gas from escaping uncontrollably. This makes them an active protective element designed to reduce the risk of accident.

Excess flow valves in the ELGEF Plus saddle

The modular ELGEF Plus assortment of tapping saddles also includes variants with an excess flow valve:

- Reduced warehouse and component costs thanks to flexibility and modular system
- Solutions for hookup and distribution lines of 15mbar to 5 bar are available on request



3.6 ELGEF Plus Y-tapping saddle d180 – d315

New definition of tapping saddle with tool-free assembly, trail-blazing 30° Y design and optimized flow for an unbeatably easy installation.

- Tool-free assembly on the pipe
- Elastic securing strap compensates for pipe expansion of up to 3%
- Fixed limit stops for drilling
- Leak-free drilling
- Optimized flow and minimal pressure loss
- Outlet in 30° for low construction height
- Patented fusion zone design prevents peeling effect



4 Spigot fittings

The PE 100 assortment of spigot fittings from Georg Fischer is the ideal addition to the ELGEF Plus electrofusion range. Proven technology meets an enormous range of variants.

Elbows, bends, T-pieces, reductions, end caps and flange adapters are available in the dimension range between d20 and d1000 mm. They are easy to integrate into the ELGEF Plus system using ELGEF Plus couplers or molded parts. Depending on the installation situation, these can also be butt-welded.

4.1 System advantages of ELGEF Plus spigot fittings

Georg Fischer spigot fittings d20 – d1000 – comprehensive assortment

First and foremost, the assortment of spigot fittings from Georg Fischer includes a wide range of variants. The width and depth of the range are crucial for their main applications. Numerous reductions and T-pieces with reduced outlets provide further help in special situations.

This increases your installation flexibility and reduces your effort on site, thus saving costs.

Georg Fischer spigot fittings d20 – d315 – individually packed in PE protective bags

Immediately after production, the spigot fittings from Georg Fischer are packed in PE protective bags and boxes. As with the ELGEF Plus electrofusion fittings, this prevents oxidation of the surface due to UV light. In other words, when the spigot fittings are transported and stored correctly, you can dispense with peeling the fittings on the construction site:

- This reduces your installation time
- It thus saves installation costs

Georg Fischer spigot fittings d20 – d315 – complete traceability

All spigot fittings from Georg Fischer are consistently equipped with the traceability bar code.

This increases your installation flexibility and reduces your efforts on site, thus saving costs:

- You feel secure in the knowledge that all quality-relevant factors of the fusion connection have been sustainably documented
- Reduced search costs when damage occurs

Georg Fischer Spigot fittings d355 – d800 – designed for BIG ideas

Large dimensions are a major challenge for users and installers. Injection-molded coupler fittings up to d500 mm support installation with features such as:

- Angle / insertion depth markings on the spigot
- Supporting surfaces for a spirit level
- Centering aid for flanges

Up to dimension d800 mm, Georg Fischer offers spigot fittings which are fully pressure-resistant and have no pressure reduction factor.



+GF+ Country of Origin: Switzerland
ELGEF Plus

T 90° egal
 Té 90° égal
 T 90° Equal
 T 90° Ugualle

Standards
 EN ISO15494
 EN1555
 EN12201
 ISO4427
 ISO4437

Approvals
 APE
 KIV S115/1
 S-PN 15
 DIV-8667CM0027
 EN 1227-3 part 8
 EN 1585-3 part 8

753201017 **1x**

d160 metrisch LS 99999 Batch No 999999

PE100 SDR11 PN16 GAS/W/P Prod. date 02.2023

Traceability

3736051609999912708100329 7 631704 366798

Georg Fischer Wavin AG, 8201 Schaffhausen/Switzerland www.gfps.com



5 Valves for applications in the utility segment

5.1 System advantages for plastic valves in the utility segment

Plastic valves are now an integral part in the range of valves. There is good reason for this: They are not affected by corrosion, are lightweight, and take up less space.

The plastic valves can be incorporated into the piping network either by using proven jointing technology techniques such as electrofusion welding or mechanically.

5.2 ELGEF Plus pressure tapping valve

The pressure tapping valves d63-400mm are part of the modular system and offer maximum flexibility in combination with the ELGEF Plus Duoblock saddle. The DAV can be optimally used as a branch valve for extending the distribution network and offers the fastest installation time compared to other branch solutions. Pressureless and pressurized gas and water pipes are drilled using the DAV. The integrated valve function makes it possible to shut off the branch line at any point during the lifespan with no maintenance required.

- PE 100 casing for perfect corrosion protection
- Selected materials for zero maintenance and a long working life
- Chip-free drilling and a secure hold of the PE pipe piece in the rotary stainless steel drill cutter
- Maximum safety using gas-free tapping and shut-off function
- Limitlessly variable installation and assembly thanks to the 360° rotatable outlet

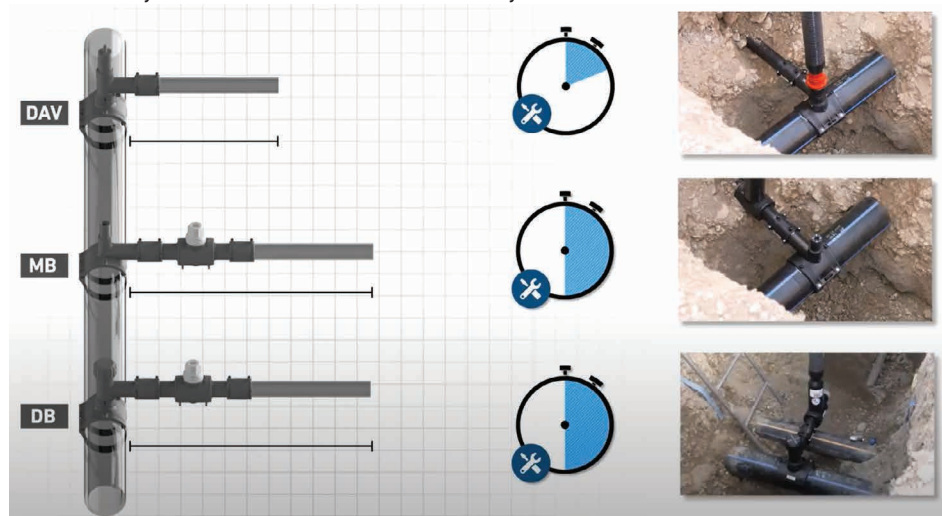

5.3 ELGEF Plus ball valve

The ELGEF Plus ball valves from GF Piping Systems have been specially designed for underground gas and water distribution piping systems. Made entirely of plastic, they are corrosion resistant and maintenance-free. This ensures a service life of well over 50 years. The ball valves can be flexible and easy connected to other components of the modular ELGEF Plus system.

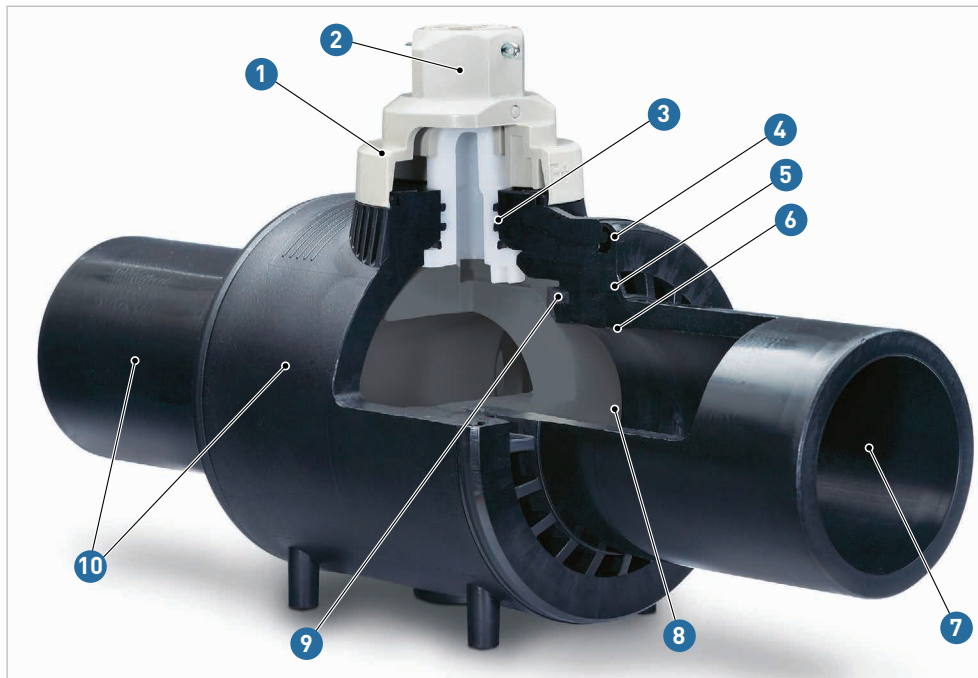

- 1 Lip seal to repel dirt
- 2 Extension spindle connection with polygon and square profile per DVGW GW 336
- 3 Triple O-ring seal
- 4 Covered bead
- 5 Reliable and leak-free socket fusion joint between housing and spigot ends
- 6 Sealings approved for water and gas applications
- 7 Smooth inner surface of spigots prevents deposits and incrustation
- 8 Injection-molded ball made of PVC
- 9 Optimized ball seal system
- 10 PE 100 spigot ends and housing

Optimized ball seal system

The innovative sealing system for d90 and d110 mm offers you extra safety, even under the extreme installation conditions often found on building sites. With the new sealing geometry and static and dynamic sealing components, the ball is safe float and encapsulated, optimal for all situations.



Injection-molded ball

The ball is manufactured in one piece in a modern injection moulding process, giving the ball a smooth surface, which could never be achieved with machining. This leads to optimal flow conditions in the opened position, minimizing disruptive flow turbulences and pressure losses.



Triple O-ring seal

The triple O-ring seal of the torque transmission head ensures 100% tightness to the outside, even under extreme temperatures. This is a definite plus in terms of your safety.

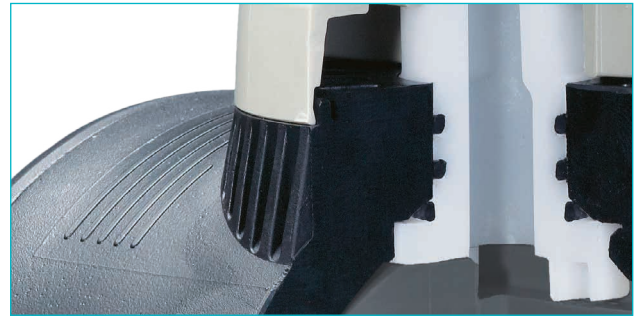

It is essential that the installation instructions are followed during assembly of the ELGEF Plus ball valve. In addition, an operation test is recommended before installing the ELGEF Plus ball valve in the system. For this, close and then reopen the ball valve before installation.

5.4 NeoFlow pressure regulating valve

The pilot-controlled NeoFlow pressure regulating valve from GF Piping Systems is designed to reduce the pressure and flow in water distribution networks. The NeoFlow pressure regulating valve is designed in such a way that it can be placed between the PN 10/PN 16 standard flanges in an intermediate flange arrangement. The ANSI 150 flange compatibility is likewise ensured (excl. DN80).

Intelligent valve

The integrated pilot valve ensures optimized pressure regulation; with additional equipment that can be optionally integrated for monitoring of flow and water quality.

No drive rod or diaphragm

Considerably reduced complexity. Low maintenance requirements thanks to very simple light-weight design with few components and without elastomer membrane.

Axial flow

Very precise and stable flow (up to zero), even with minimal differential working pressure. Higher flow precision and the option for pressure management even in low pressure systems.



Functional principle

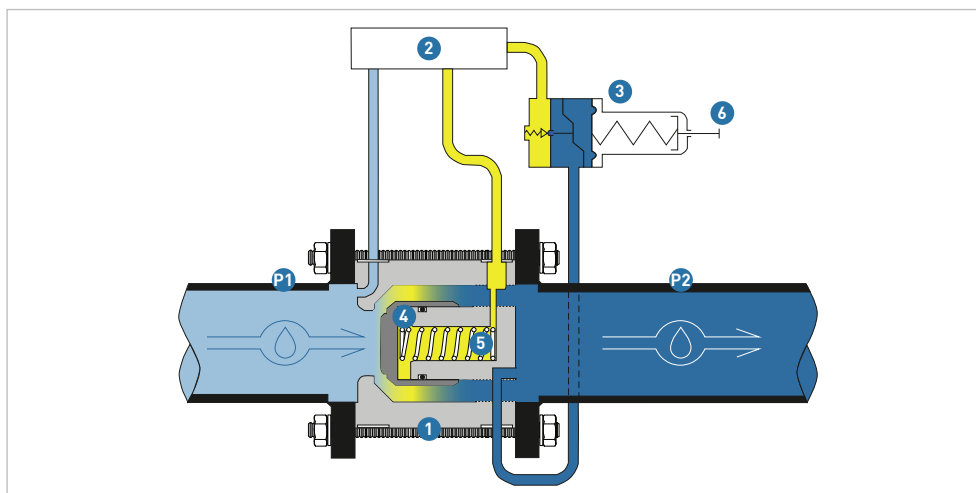

- 1 Main body
- 2 Control block
- 3 Pilot valve
- 4 Valve piston
- 5 Control space
- 6 Adjustment screw
- P1 Input pressure
- P2 Output pressure, adjustable

The axial movement of the valve piston (4) in the main body (1) leads to changes in flow in the NeoFlow pressure reduction valve and thus regulates the adjacent output pressure (P2). The position of the valve piston (4) is regulated by the prevailing pressure in the control space (5). Turning the adjustment screw (6) on the pilot valve (3) sets the desired output pressure (P2). The media flow in the pilot valve (3) changes depending on the adjacent output pressure (P2). A change to the media flow leads to an adjustment of the pressure in the control space (5) above the control block (2). The valve piston (4) moves axially in the main body (1) to equalize the pressure.

Arrangement of valves

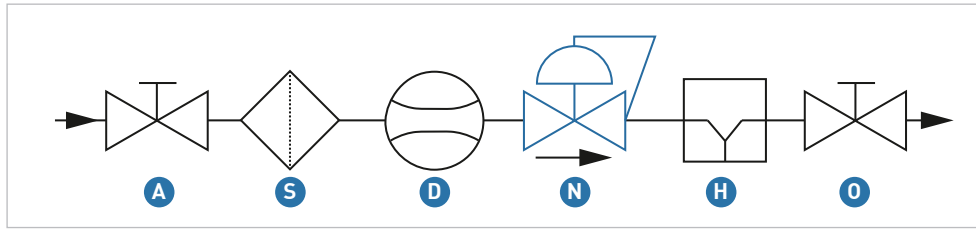

- A** Shut-off valve, on input side
- S** Strainer
- D** Flow meter
- N** NeoFlow pressure reduction valve
- H** Hydrant/splitter (recommended)
- O** Shut-off valve, on output side

Specifications

Dimensions	d63/DN50 – d315/DN200, 2" – 12"	
Materials	Housing	POM-C
	Piston	POM-C
	Elastomers	EPDM
	Fittings	Stainless steel/brass
	Pilot control	Stainless steel, POM-C, PTFE
Pressure levels	Maximum input pressure P1	16 bar*
	Maximum input pressure P2	16 bar**
	Output pressure range	0.1 to 16 bar**
	Minimal pressure difference P1-P2	0.2 bar***
Flange	Metric: PN10/16 Imperial: ANSI 150	
Valve control	Pilot controlled: Mechanically controlled pilot valve	
Classification according to ISO 1043	POM	
Standards	EN1074-1	
	EN1074-5	

*With fluid temperature ≤ 20 °C: >20 °C on request

**Depending on pilot valve type

***Depending on flow and size

Flow characteristics

Kv 100 values

DN (mm)	Do2 (mm)	Inch (")	Kv 100 (l/min)	Kv 100 (m ³ /h)	Cv 100 (US gal./min)
50	63	2	500	30	35
80	90	–	1217	73	84
100	110	4	2167	130	150
150	160	6	4433	266	307
200	225	8	9417	565	653
250	280	10	12 883	773	894
300	315	12	16 733	1004	1161



6 Electrofusion units

6.1 Overview of electrofusion units



Characteristics	MSA 125	MSA 315	MSA 330	MSA 340	MSA 2.0	MSA 2.1	MSA 2 MULTI	MSA 2 CF	MSA 4.0
Material	PE, PP	PE, PP	PE, PP	PE, PP	PE, PP	PE, PP	PE, PP, PB, PVDF	PE, PP, PB, PVDF	PE, PP
Working temperature range (°C)	-10/+45	-10/+45	-10/+45	-10/+45	-20/+50	-20/+50	-20/+50	-20/+50	-20/+50
Protection rating	IP54	IP65	IP65	IP65	IP65	IP65	IP65	IP65	IP65
Switch	✓	✓	✓	✓		✓		✓	✓
Input voltage (Vac)	230	230	230/115	230/115	230	230	230	115	230
Output voltage (Vac)	8-42	8-42	8-48	8-48	8-48	8-48	3.6-40	3.6-40	8-48
Output current (Amps)	50	70	100	100	90	90	90	90	110
Fusion data input with bar code	Optional	Optional	✓	✓	✓	✓	✓	✓	✓
Manual fusion data input	✓	✓	✓	✓	✓	✓	✓	✓	✓
Operator ID/order no.		✓	✓	✓		✓	✓	✓	✓
Protocols	350	500	1000	1000	350	1000	500	1000	5000
Fusion data format	PDF, CSV	PDF, CSV	PDF, CSV	PDF, CSV		PDF, BIN	PDF, BIN	PDF, BIN	PDF, BIN
Traceability (ISO 12176-4)				✓					✓
GPS				✓					✓
Interface	USB	USB	USB	USB	USB	USB	USB	USB	USB
Integrated Bluetooth						✓			✓
Configurable/admin-supported menus			✓	✓		✓		✓	✓
Weight (kg)	13	17	19	19	11.9	11.9	11.9	12.5	12.5
Network cable length/fusion cable length	4 m/3 m	4 m/3 m	4 m/4 m	4 m/4 m	4 m/3 m	4 m/4 m	4 m/3 m	4 m/4 m	4 m/4 m
Fusion plug	4 mm	4 mm	4-4.7 mm	4-4.7 mm	4 mm	4-4.7 mm	4 mm	4 mm	4-4.7 mm
Transport case	✓	Optional	Optional	Optional	✓	✓	✓	✓	✓
Welding book application	Optional	Optional	Optional	Optional		✓	✓	✓	✓
WeldinAir			Optional	Optional	Optional			Optional	
Rental time app			✓	✓					✓

6.2 Installation guidelines – fault prevention

Frequent causes of fault and remedial measures

Below is a list of causes that can lead to faults during electrofusion as a result of careless preparation, but are easy for the expert personnel to prevent if they observe a small number of principles:

The faults in heating element fusion joints are described in detail in DVS 2202, Supplement 2. In the following, we provide a short description of the most frequent causes of faults as well as remedial measures, without going into the details of the description, the test methods or the evaluation criteria.

Figure	Cause of fault	Remedial measures
	Insertion depth scribed incorrectly or not at all	Mark correctly and follow instructions
External welding fault – insertion depth		
	There is no visible machining extending beyond the fitting body, or the visible mechanical machining is e.g. <ul style="list-style-type: none"> • Irregular • Insufficient (chip thickness) • Not continuous • Not present • Excessive (pipe undersized) • Inadmissible (manual scraping for PE-X) 	Mark correctly and follow instructions Suitable peeling device and regular maintenance
External fusion fault – insufficient peeling		
	Angular deviation with displacement of heating coil and melt with or without separations in the joining plane, increased material flow, caused by e.g. <ul style="list-style-type: none"> • Non-flush pipe ends • Inadequate curvature radii in the case of ring coils • Bending moment on the fitting • Movement during the heating and cooling phase In extreme cases, this incorrect laying can lead to local overheating with smoke and flame development.	Use of clamping devices
Internal fusion fault – twisting		
	Channel formation locally, over large areas or radially around the circumference, e.g. caused by <ul style="list-style-type: none"> • Notches and/or furrows in the pipe surface • Deviating diameter tolerance (undersized pipe) • Incorrect peeling • Mechanical damage • Flaking 	Suitable peeling device and regular maintenance Replacing the peeling tool blade
Internal fusion fault – shape inaccuracy		
	Pipe ends offset on one or both sides in the fitting or not touching each other or the stop, melt emergence on the inside or outside, e.g. caused by <ul style="list-style-type: none"> • Pipe end not cut off at a right angle In extreme cases, this incorrect laying can lead to local overheating with smoke and flame development.	Cutting of the pipe ends at right angles Use a suitable pipe cutter
Internal fusion fault – pipe cut off at an angle		
	Incomplete joint locally or over large areas with or without separation in the joining plane <ul style="list-style-type: none"> • E.g. caused by insufficient fusion energy (premature fusion termination, wrong fusion data) • Moisture • Contaminated surface • Impermissible material combinations 	<ul style="list-style-type: none"> • Precleaning of the pipe, cleaning in the peeled area only; clean, lint-free paper; solvent evaporates completely, avoid touching the cleaned pipe surface. • Use data of fitting to be welded only • Comply with cooling time and avoid time pressure
Internal fusion fault – inadequate material bond		

Figure	Cause of fault	Remedial measures
 <p data-bbox="124 347 422 398">Internal fusion fault – SDR class not permissible</p>	<p data-bbox="571 206 1141 318">Wall thickness of the pipe is outside of the SDR range specified by the fitting manufacturer. In extreme cases, this incorrect laying can lead to local overheating with smoke and flame development.</p>	<ul data-bbox="1149 206 1481 347" style="list-style-type: none"> • Check compatibility on the bar code label before welding • Use data of fitting to be welded only

Rewelding

If fusion is aborted due to external effects (e.g. generator failure), one-time rewelding can be carried out after the materials have completely cooled down to the ambient temperature. The following points must be adhered to:

- Checking and correction of the cause of fault. The relevant error message from the fusion device gives indications as to the possible cause of fault.
- It is not permitted to remove the clamping devices holding the joint.
- The fitting must be protected from contamination and moisture. It is not permitted to use additional coolants (cold water etc.) to accelerate the cooling process.

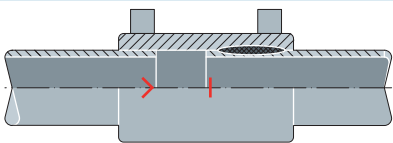
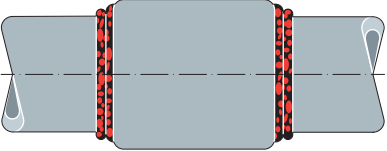
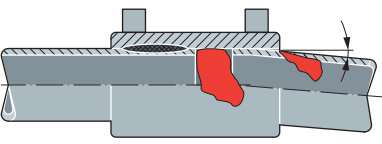
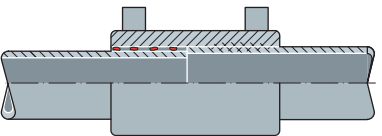
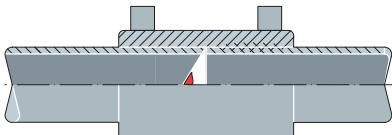
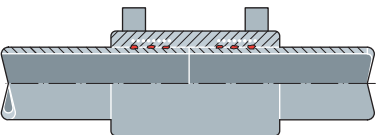
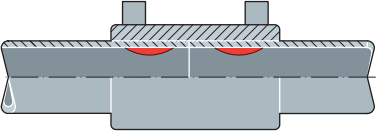
Checking of the fitting resistance at the fusion device: Fitting resistance must be cooled down and returned to the initial value. It is not permitted to reweld fusion connections if the leak test was unsuccessful.

6.3 Butt fusion machines

6.3.1 Overview



Characteristics	TM160	TM250	TM315	GF400	GF500	GF630	GF800	GF1000	GF1200
Max. dimension (mm)	160	250	315	400	500	630	800	1000	1200
Material	PE, PP, PB			PE, PP, PB			PE, PP		
Temperature range (°C)	-10/+45			-10/+45			-10/+45		
Input voltage (V)	230/115	230	230	400	400	400	400	400	400
Operation	Manual, CNC			Manual, CNC			Manual		
Performance (W)	1900	3250	3850	5700	6300	11 000	15 000	19500	20 500
Reduction clamp insets / flange adapter clamp	Optional			Optional			Optional		
Hoist unit	-			Optional			Optional		
Chamfered clamping saddle	Optional			Optional			-		
Fusion protocols, transfer using USB stick	WR 200 (optional), CNC			WR 200 (optional), CNC			WR 200 (optional), CNC		
Traceability via bar code scanner	TOP, CNC			TOP, CNC			-		
Weight basic machine (kg)	22	47	53	95	169	222	690	1238	1370
Work range [mm]									

6.3.2 System advantages

Extensive assortment of trench and workshop machines

Automatic butt fusion machines for pipes made of PE and PP for use on the construction site and in the trench.

Safe and efficient to use thanks to:

- High-quality components and processing
- Reliable and robust even under tough construction site conditions
- User-friendly operation
- Application-specific consulting and demonstration on site

Trench machines as ECOS version up to d315, as conventional line up to d1200 or CNC-equipped up to d630

The GF trench machines offer a wide range of variants to suit your needs and allow you to select individual machines that cater precisely to your projects.

- Handy and lightweight trench machines TM ECOS up to d315mm.
- High-quality, user-friendly and flexible TOP 2.0 – GF trench machines with manual control up to d1200mm.
- Automatic CNC 4.0 trench machines up to d630mm. The CNC equipment increases safety and monitoring throughout the fusion steps.

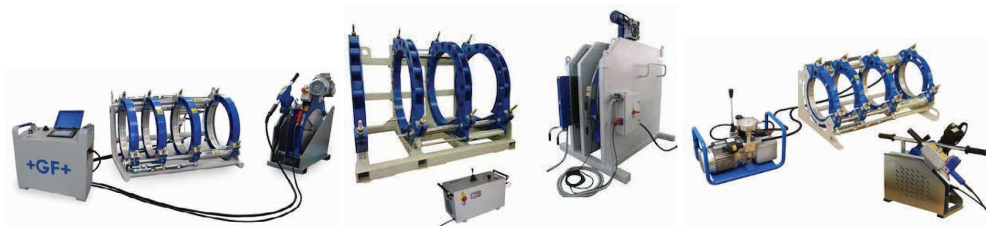

TM ECOS 160-315

TOP 2.0 – GF 160-1200

CNC 4.0 160-630

Data recording for all butt fusion machines

All GF butt fusion machines allow data recording using additional equipment WR200/WR200S.

Safe and efficient to use thanks to:

- Simple and cost-effective to retrofit
 - Suitable for all trench and workshop fusion machines
 - A recording device which can be used for several machines
- Simpler and faster than filling out a manual fusion protocol in accordance with DVS 2207
- Data can be inputted into other data processing systems to guarantee seamless documentation of the pipe system.



TOP 2.0 & CNC 4.0 WeldinAir

All GF butt fusion machines allow data recording using additional equipment, namely the TOP 2.0. Butt fusion machines offer integrated fusion data recording.

Both the TOP 2.0 (as standard) and the CNC 4.0 (special WeldinAir version) offer a Bluetooth interface for real-time communication with smartphones to monitor the fusion process and to transfer the fusion data directly from the construction site. This is done in combination with the mobile application WeldinAir.

WeldinOne software for butt fusion and electrofusion.

The WeldinOne software allows all important functions for

- Documentation (fusion data, photos, coordinates)
- Configuration of devices (access control, languages, documentation scope)
- Generation of additional bar codes (welder's ID, order number, identification of tools used) to be set up comfortably and conveniently from a PC/laptop.

For GF butt fusion and GF electrofusion, WeldinOne can be used with the following butt fusion machines:

- All GF CNC butt fusion machines
- GF fusion data recording devices (WR200/WR200S)
- GF infrared fusion machines IR Plus 63-315



7 Tools and accessories for electrofusion

7.1 Overview

The tools used for electrofusion must be coordinated with the electrofusion system. The following table is an overview of the tool groups and accessories, including a representative example:

Figure	Tool group and accessories	Dimension ranges	Purpose
	Rotary peelers	d20 – d1200	Removes the oxide layer through mechanical processing of the pipe or spigot end during fusion preparation
	Cleaning agent	-	Residue-free cleaning of the welding surfaces during pipe preparation
	Cutting tools	d10 – d1600	Allows plastic pipes to be separated at right angles
	Tapping tools	-	For the drilling of tapping saddles
	Clamping and alignment tools	d20 – d630	Allow stress-free installation during the welding and cooling process
	Installation tools (topload)	d280 – d630	For welding tapping saddles and branch saddles
	Installation tools (topload)	d315 – d2000	Welding branch saddles
	Re-rounding tools	d25 – d2000	Mechanical compensation of pipe ovalities during the welding and cooling process
	Squeeze-off tools	d20 – d250	Mechanical squeeze-off tools are suitable for shutting off (squeezing off) PE pipes during repair and extension work.
	Marking and measuring	-	Determining the diameter of the components to be fused. Marking the peeling area and the insertion depth

T5.1
Overview of tools and accessories for electrofusion

7.1.1 Demands on generators

Generators

Generators are used to ensure a reliable supply of electricity to the electrofusion unit at construction sites. Please note the following requirements:

- Generator maintained regularly (at least once yearly according to DVS) with sufficient output power for the fusion device and the electrofusion fittings to be welded
- Sufficient fuel for the generator for the time it takes to make the necessary fusion connections
- The generator only supplies the fusion device (no other consumers)
- The generator provides the fusion device with a safe and stable electrical network – even under load – within the following framework:
 - Output >3.5 kVA (or from d355 >6 kVA)
 - Power supply from 230 V \pm 10 %
 - Frequency 50 Hertz \pm 10 %
 - Current (back-up fuse) 13 to 20 A

7.1.2 System advantages

MSA electrofusion units – to suit your individual requirements

The assortment of electrofusion units provides you with four different versions so that you can find a suitable fusion device to suit your individual requirements.

- MSA 2.0 and MSA 2.1: Automatic and practical electrofusion unit with or without documenting – intuitive, cost-efficient and high-performance.
- MSA 4.0: Electrofusion unit for higher demands when it comes to documenting, product traceability, GPS function and Bluetooth scanner – user-friendly, flexible and connected.



MSA electrofusion units – effortless handling

The MSA electrofusion units are particularly focused on simple and effortless handling in practice.

- Comfortable to carry with its ergonomically shaped carrying handle and lightweight at just 12 kg
- Simple and safe cable winding
- Reliable and simple logging of the fusion bar code using a scanner
- Intuitive, simple operation with large display and use of symbols and large script
- Clear error messages and acoustic signals or online help (MSA4.x)



MSA electrofusion units – efficient and high-performance

- With MSA electrofusion units, you can be sure you are using your equipment in the most cost-effective way.
- High power output through use of efficient voltage inverters allows application for large pipe couplers
- Can be used in all weather conditions from -20 °C to +50 °C.
- Active cooling enables cost-efficient work with series fusion



MSA electrofusion units – secure and reliable

MSA welding machines guarantee safety and reliability in electrofusion.

- Easy-to-reach emergency off switch (on/off) in case of danger
- IP65 protection against dust and water for safe working under extreme construction site conditions.
- Fusion process automatically cuts out when there is a fault (generator, environmental influence, fitting)
- Safe and fast data exchange via USB interface
- Comprehensive data documentation covering the fusion process (GPS coordinates, product data, traceability, information on order and welder, photos/video of installation conditions on site)



WeldinOne/WeldinAir software for butt fusion and electrofusion.

WeldinOne

- Software applications for support with fusion or plant maintenance.
- The software applications are suited to all GF electro/butt and infrared fusion machines that are able to compile protocols.
- The welding book creates PDF documents including determining the position of the fusion location, photos of the planer sequences as well as the precise alignment.
- The bar code generator creates operator ID, order number and the identification of other tools to support the installer in retracing the works.
- The MSA configurator creates various graphic device configurations for MSA 4.0, which can be uploaded onto the fusion devices using the USB stick. The bar codes can also be used for the whole MSA range.

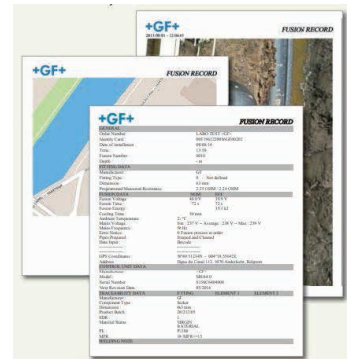

WeldinAir

WeldinAir is a mobile Bluetooth interface; existing electrofusion units in the MSA range of products can be retrofitted with a Bluetooth interface. This interface works in collaboration with an app which can be installed on any smartphone (iOS or Android). Compatible with MSA 330, MSA 340, MSA 2.1 and MSA 4.0 without a Bluetooth interface fitted at the factory.

Can be used as a standalone, with WeldinOne or with CONNECT Conrivo.



7.2 Tools and aids

For detailed information on the products as well as instructions for handling our tools, please see the catalogs and the relevant operating manuals.

7.2.1 Cleaners and tools

Special plastic cleaning fluids are used for thorough cleaning and degreasing of smooth surfaces. They are essential for preparing pipes, fittings, profiles, tins and sheeting, ensuring secure plastic jointing.



7.2.2 Peeling tools

GF Piping Systems reduces the work involved in peeling. The easy-to-use peeling tools provide consistent peeling quality for the preparation of pipe surfaces.



Work range [mm]	Rotary peeler RS	RST 1000	RSE	RSE Multi	RSE Multi 90-180	RSE Multi 180-400	RTC 710
20							
25							
32							
40							
50							
63							
75							
90							
110							
125							
140							
160							
180							
200							
225							
250							
280							
315							
355							
400							
450							
500							
560							
630							
710							
800							
900							
1000							
1200		Optional					

With dividing line: 1 tool per dimension

Without dividing line: cross-dimensional tool

7.2.3 Clamping and installation tools

These tools are designed to aid smooth installation with minimal movement during the fusion process and the cooling process, and are easy to position. The GF Piping Systems assortment covers several innovative versions for maximum functionality.



Work range [mm]	Multi clamp holders	Clamping tool 2 pcs	Clamping tool 2/4 pcs	Clamping tool 2/4 pcs with joint	Clamping tool 2 pcs	Clamping system TL400	Clamping system TL630	Installation set topload TL225	Installation set topload TL500
20									
25									
32									
40									
50									
63									
75									
90									
110									
125									
140									
160									
180									
200									
225									
250									
280									
315									
355									
400									
450									
500									
560									
630									
710									
800									
900									
1000									
1200									
1200									
1200									
1200									
1200									

With dividing line: 1 tool per dimension

Without dividing line: cross-dimensional tool

7.2.4 Cutting tools

Precise cutting of a pipeline requires the use of a cutting tool that is up to the task.

The GF Piping Systems assortment covers cutting tools that can quickly and cleanly separate the many different piping dimensions and materials.



Work range [mm]	Plastic pipe cutter	RPC 63-200	RPC 90-315	KS 355	PEcut 1200
20					
25					
32					
40					
50					
63					
75					
90					
110					
125					
140					
160					
180					
200					
225					
250					
280					
315					
355					
400					
450					
500					
560					
630					
710					
800					
900					
1000					
1200					

7.2.5 Drilling, tapping and testing tools

Pressure testing and drilling tools make it possible to create connections with existing pipelines and to check for any leaks after installation. There are solutions available for both pressure-less and pressurized pipelines. GF Piping Systems offers a wide range of durable tool sets and individual tools in the highest quality so that they can meet every requirement.



7.2.6 Rerounding and squeeze off tools

The heavy-duty rerounding tools support the simple rounding of out-of-round PE pipelines before or during electrofusion. The simple-to-operate and durable squeeze off tools are suited to squeezing off PE pipelines during repair and expansion works. They also enable pipeline repairs without the need to drain the system.



7.3 Maintenance and rental

The DVS 2208 prescribes “at least an annual check” by a certified service center for machines and tools used for butt fusion heating element and heating coil (electro) fusion.

In addition to maintenance and repair of your machines and tools, we offer you ongoing availability of machines and tools to rent. We guarantee short cycle times and reliable maintenance of your high-quality equipment.

For sporadic requirements of special measurements, it can be more economical to rent the required machines and tools instead of buying them.

We are able to provide you with a completely up-to-date, ready-to-use rental assortment with more than 100 fusion machines and tools at attractive conditions, all inspected after each use.



Local support around the world

Visit our webpage to get in touch with your local specialist:

www.gfps.com/our-locations



More information for
Industry, Utility and Building Technology online



Price 65 EUR