

GF Piping Systems

+GF+

# Vinyl Catalog and Technical Information 2019

Schedule 80 PVC

Schedule 40 and ChlorFIT® Schedule 80 CPVC

Schedule 40 PVC

Schedule 40 and 80 PVC

Harvel Speciality Pipe

Extruded Shapes

Metric PVC

Valves



# Your Complete Vinyl Piping Systems Supplier

and Global Leader in Plastic Piping Systems



[www.gfps.com](http://www.gfps.com)

## Metric-To-Inch Conversion Chart

16 mm = 3/8"	50 mm = 1 1/2"	160 mm = 6"	400 mm = 16"
20 mm = 1/2"	63 mm = 2"	225 mm = 8"	450 mm = 18"
25 mm = 3/4"	75 mm = 2 1/2"	280 mm = 10"	500 mm = 20"
32 mm = 1"	90 mm = 3"	315 mm = 12"	600 mm = 24"
40 mm = 1 1/4"	110 mm = 4"	355 mm = 14"	

- + Pipe
- + Fittings
- + Valves
- + Instrumentation

# Table of Contents

<b>Overview Vinyl Technical Information</b> . . . . .	<b>4</b>
Product Summary . . . . .	4
Cell Classification . . . . .	4
Temperature Effects . . . . .	4
Benefits with Respect to Metallic Piping . . . . .	5
GF Piping Systems Quality Control . . . . .	5
Applications . . . . .	6
<b>Material Data: Physical Properties</b> . . . . .	<b>8</b>
<b>Engineering Design</b> . . . . .	<b>10</b>
Pressure Rating . . . . .	11
Surge Pressure (Water Hammer) . . . . .	14
Thrust Blocking . . . . .	15
Temperature Effects . . . . .	18
Thermal Expansion and Contraction . . . . .	22
Friction Loss . . . . .	28
<b>Installation Instructions</b> . . . . .	<b>48</b>
Storage and Handling . . . . .	48
Thermoplastic Piping Tools . . . . .	48
Joining Techniques . . . . .	49
Gasket . . . . .	58
Support Installation . . . . .	65
<b>List of Symbols</b> . . . . .	<b>81</b>
<b>Glossary</b> . . . . .	<b>82</b>
<b>Reference Tables</b> . . . . .	<b>84</b>
<b>Useful Formulas and Symbols</b> . . . . .	<b>92</b>
<b>Industry Standards</b> . . . . .	<b>93</b>
<b>Product Specifications</b> . . . . .	<b>95</b>
PVC Industrial Pipe: Schedule 40 . . . . .	95
PVC Industrial Plus Pipe: Schedule 40 . . . . .	96
PVC Industrial Pipe: Schedule 80 . . . . .	97
PVC Industrial Plus Pipe: Schedule 80 . . . . .	98
PVC Industrial Pipe: Schedule 120 . . . . .	99
CPVC Industrial Pipe: Schedule 40 & 80 . . . . .	100
<b>Vinyl Catalog</b> . . . . .	<b>103</b>

# Overview Vinyl Piping Systems

## Product Summary

### PVC

Polyvinyl Chloride (PVC) is an amorphous thermoplastic material that can be formulated, or compounded, to target a specific application. Minor ingredients must be blended with PVC resin to create a PVC compound that is processable into a finished product. The physical properties of PVC can be altered considerably to provide desirable properties by compounding techniques. Additives such as impact modifiers, stabilizers, lubricants, processing aids, pigments, and other ingredients can be modified to obtain desirable properties. As such, PVC is available in a wide range of compounds formulated specifically for the productions of different PVC product lines. This ensures tight control over consistency and quality in the end product, which has been optimized for chemical resistance and pressure bearing capability. GF Piping Systems PVC materials are compliant with NSF/ANSI Standard 61 Drinking Water System Components – Health Effects and NSF/ANSI Standard 14 Plastics Piping System Components and Related Materials as being safe for use in potable water applications.

### CPVC

Chlorinated polyvinyl chloride (CPVC) is created by subjecting PVC resin to a post chlorination reaction that results in additional chlorine atoms on the base molecule. This results in an amorphous thermoplastic material similar to PVC with added advantages: a higher heat distortion temperature and improved fire performance properties at relatively low cost compared to alternate materials. As with PVC, the physical properties of CPVC can be altered considerably to provide desirable properties by compounding techniques. Due to its higher heat distortion temperature, GF Piping Systems CPVC can be used in piping applications up to 60°F (33°C) higher than PVC piping. GF Piping Systems CPVC provides an economic solution for piping utilized in process piping, hot water, and similar service applications where operating conditions exceed the recommended temperature limits of PVC. This greatly expands the application range for thermoplastic pipe, providing an economical solution for piping used in elevated temperature service. GF Piping Systems CPVC materials are compliant with NSF/ANSI Standard 61 Drinking Water System Components – Health Effects and NSF/ANSI Standard 14 Plastics Piping System Components and Related Materials as being safe for use in potable water applications.

## Cell Classification

ASTM Standard D1784 – Standard Specification for Rigid Poly(Vinyl Chloride) (PVC) Compounds and Chlorinated Poly(Vinyl Chloride) (CPVC) Compounds calls out minimum physical property requirements of compounds that are used

in the production of PVC and CPVC pipe and fittings. This standard classifies the physical properties through a Cell Classification system that calls out base resin, minimum impact strength, tensile strength, modulus of elasticity, heat deflection temperature under load, and flammability when tested per applicable ASTM standards.

**Refer to Material Data: Physical Properties, Chemical Compatibility Awareness, and Industry Standards and Test Methods sections for additional information.**

### PVC

Unplasticized, or rigid, PVC compounds used for the manufacture of pipe and fittings has a Cell Classification of 12454 per ASTM D1784 and is also known as Type I Grade I PVC or PVC 1120.

### CPVC

Unplasticized, or rigid, CPVC compounds used for the manufacture of pipe and fittings has a Cell Classification of 23447 per ASTM D1784 and is also known as Type IV Grade I CPVC or CPVC 4120.

**NOTE: Although PVC and CPVC are similar in nature, they are not the same. Care should be used when investigating chemical resistance, joining/fabrication techniques, and service applications. GF Piping Systems utilizes several different PVC and CPVC compounds to produce different product lines. Different compounds may exhibit slight variations in actual physical properties and resultant cell classifications as compared to those stated. Contact GF Piping Systems Technical Services for additional information if necessary.**

## Temperature Effects

Thermoplastics tend to be more sensitive to temperature than metallic piping. The below sections describe properties that must be taken into account when designing with thermoplastics.

### Ductility

Ductility is the ability of a solid material to deform under tensile stress. Thermoplastics have a relatively high ductility with respect to other materials at room temperature. When the temperature drops, ductility decreases; conversely, when temperature rises, ductility increases. The Charpy Impact Test is an inexpensive test to determine relative ductility. A material with low ductility is also considered to be brittle. A brittle material is more likely to fracture under stress. See the Material Data: Physical Properties section for additional ductility information.



## Expansion and Contraction

Thermoplastics expand and contract significantly more than metals when temperature rises and drops, respectively. The thermal expansion and contraction must be considered when the system is designed. Large thermal contractions can cause large stresses in the system that must be compensated for through expansion joints, expansion loops, and/or changes in direction. A combination of the contraction of the piping and expansion of the transported fluid can cause devastating effects. See Section 3.2 for more information on designing for temperature changes.

## Cold Temperatures

Expansion and contraction affect both the transported fluid and the piping material. Water is one of the only substances that expands when frozen. When temperatures drop, pure water becomes its most dense at 39°F (4°C). As the temperature drops from 39°F (4°C) to 32°F (0°C) water expands. In a completely filled pipe, this expansion can cause the pipe to burst. Care must be taken to ensure water systems do not freeze during operation or during down-time.

Though there are potential problems associated with below freezing temperatures, given proper design thermoplastics can be used in these temperatures. Due to the loss of ductility, special care must be taken during installation to prevent significant bending in the piping. Care is also to be taken during installation and operation to prevent any impacts. Bending and impacts that would normally not cause damage can cause fractures in low temperatures. It is recommended that protection to the piping system be added to prevent accidental impacts after installation.

## Benefits with Respect to Metallic Piping

There are many benefits to using thermoplastics over traditional metal piping in non-essential systems including corrosion resistance, reduced cost, and reduced weight. The following sections highlight some of the major benefits.

### Corrosion

Metallic piping systems are subject to the following types of damage:

1. Rusting – The formation of iron oxide on iron or steel by oxidation, especially in the presence of moisture.
2. Scaling – A coating of oxide formed on heated metal.
3. Pitting – Localized corrosion confined to a point or small area that takes the form of cavities.
4. Corrosion – Deterioration due to oxides that flake away from the base metal.
5. Electrolysis – The process in which a metallic surface is continuously corroded by another metal it is in contact with.

Thermoplastics will not rust, scale, pit, or corrode, nor are they subject to electrolysis. Metallic piping will quickly corrode in many applications. You are assured many years of leak-free, maintenance-free service with GF Piping Systems

thermoplastics. Because of the corrosion protection offered by thermoplastics, painting is not required for indoor, non-exposed installations.

## Installation Costs

Generally speaking, PVC and CPVC installation costs are substantially lower than metallic systems, and material costs are competitive. Solvent cemented connections contribute to this lower installed cost while the much lighter weight speeds and simplifies handling during installation. Installation times are reduced by half, or more, when solvent welded systems are used.

## Heat Loss

Thermoplastics are less thermally conductive than their metal counterparts, which leads to less heat loss during service. This benefits you in both hot and cold service as less energy is consumed initially as the fluid retains its temperature for a longer period in thermoplastic piping.

Metal piping can also be required to have protection from condensation due to the surrounding environment. Condensation can cause metal piping to corrode and can cause damage to electrical equipment around the piping system. Special care is to be taken when metal piping is used in cold fluid service as this is when condensation is most likely to form. Thermoplastics do not require protection from condensation which reduces both installation time and costs.

## Weight

PVC and CPVC are light weight and easily transported during installation. Table 1-2 shows the density comparison between PVC, CPVC, and commonly used metal pipes. Weight is a design factor in some designs, and the weight savings in doing an entire system in thermoplastics is significant.

**Table 1-2: Densities of various materials**

Material	Density (lb/ft <sup>3</sup> )
Industrial PVC	87
Industrial CPVC	95
Copper	556
Steel	503
Stainless Steel	491

## GF Piping Systems Quality Control

GF Piping Systems has always been known for providing the highest quality products, and that is no different when it comes to the manufacturing of our vinyl products, PVC and CPVC. While other manufacturers may consider these materials commodities, we consider them highly engineered fluid delivery systems that must satisfy demanding applications and are no different from the many other thermoplastic piping systems we manufacture. The same rigorous attention to detail, material qualification, raw material testing, and in-process quality assurance are essential steps that we apply to maintain these same consistently high standards of quality you've come to expect from GF Piping Systems.

It starts with the right choice of raw materials, choosing the best suppliers, and verifying that each and every shipment received meets our high standards. We insist on strict quality control throughout the entire manufacturing process to make sure our products not only meet or exceed our stringent specifications but also look good, provide trouble-free installation, and provide years of service. Finally, we take extra care in packaging and protecting the products before they leave our plant. You can expect the product to arrive at the job site in the same excellent condition as when it left our plant.

### **Raw Material Qualification Steps**

Before any raw material can be processed, batches are checked for density and moisture content. Then they are separated by batch number to ensure there is no possibility of unintended blending of raw materials. In addition, raw material is compared to control samples. Inconsistent pellet size, pellet geometry, and contamination are cause for material rejection.

Once preliminary checks are complete, the resin is checked with a Brabender or torque rheometer that simulates the way the material will behave when processed through molding machines and extruders. If raw material is out of specification, it will be rejected at this time.

Next, the resin is heated and pressed to flatten the material to under 1/10 in (2.5 mm) with several tons of pressure. This is used to check for correct color using a color platen. It is then analyzed using the color spectrometer. If the material's color is out of tolerance and does not meet specification, the material is rejected.

After color check, the melt flow indexer is used to measure the viscosity of the material and how it will behave in the molding and extrusion processes. If the material passes this final step, it can then be released to production.

Each batch of raw material is retained for five years. This provides traceability in case of a post-manufacturing material issue. Markings on a fitting or pipe allow traceability back to each batch of raw material used in production.

Samples of finished product are also retained on a regular basis. As with the raw material, if a problem is suspected, it can be compared to the retained sample to help confirm visual and dimensional conformance. Traceability is an integral part of the quality process.

### **In-Process Manufacturing Steps**

A coordinate measurement machine (CMM) is an extremely precise measuring device that is used to qualify dimensional tolerances on finished products. In many cases, the GF Piping Systems specifications are tighter than ASTM specifications. When making solvent cemented joints, a proper fit-up between pipe and fitting is important to ensure leak-proof connections. Too big of a gap can result in weak joints and possible premature failure.

Fittings are routinely pressure tested to failure. This process helps understand safety factors and ensures the fitting meets or exceeds ASTM standards.

In addition to pressure tests, fittings are also crushed under extreme pressures. ASTM requires a 25% compression in order to pass. A GF Piping Systems fitting will usually meet a 75% or better compression without fracture. Fittings that pass this test are considered ductile and will not fail catastrophically.

All manufacturing processes are constantly monitored, recorded, and analyzed to make sure products are produced to the most exacting specifications. In most cases, the GF Piping Systems internal tolerance and safety factor requirement specifications are tighter than industry standards and ASTM tolerances.

### **Packaging and Handling**

All of these efforts to produce the highest quality part would be lost unless we ensure they are delivered to our customers in the same high quality condition they were produced. Unlike other manufacturers, GF Piping Systems wraps every lift of PVC and CPVC pipe in UV resistant plastic and encloses pipe ends so it arrives clean and free of scratches.

### **Applications**

GF Piping Systems PVC and CPVC piping products can be found in applications in the following industries where water, chemical and corrosive fluid production, transfer, and mixing are utilized:

#### **Chemical Process Industries:**

Chemical Processing - Industrial Waste - Laboratory Semiconductor - Pulp and Paper - Electroplating - Electronics Metal Treating - Chlor-Alkali - Fertilizer - Color Industries - Textile - Mining - Air Pollution Control - Photo Finishing - Printing

#### **Industrial Processing:**

Plant Water Distribution - Cooling Water - Waste-Water - Process Water - Reclaim - Waste Treatment - HVAC Pollution Control - Brine Production and Disposal

#### **Power Generation:**

Boiler Feed Water - Atomic Energy - Fly Ash Slurries - Coal Mining - Gas Industry - Oil Refining Cooling Water - Water and Waste Water Treatment

#### **Food and Beverage:**

Potable Water - Bottled Water - Ultra-Pure Water - Food Processing - Meat Packing - Poultry Farming and Processing Distilled Water - Ice Production and Equipment



**Water and Waste Water:**

Water Treatment - Waste Water Treatment - Reclaim Aeration  
- Desalination - Detention and Collection - Water Resource  
Conservation - Ground Remediation - Well Casing and Well  
Monitoring

**Aquaculture:**

Life Support Systems - Public Aquariums - Fish Hatcheries  
- Lobster Ponds - Fish Ladders - Fish Farming

**Recreational:**

Water Parks - Theme Parks - Fountains - Water Features -  
Swimming Pools

**Agricultural/Irrigation:**

Commercial Irrigation - Golf Courses - Farming - Genetic  
Engineering - Greenhouses

**General Services:**

Hot and Cold Water Plumbing - Municipal Water - Process  
Water - Commercial Roof Drain - Bridge Drain - Industrial  
Parks - Shopping Centers - Surface Drainage - Landfill -  
Marine Applications - Drain, Waste, and Vent (DWV)

**Specialty Applications:**

Visual Leak Detection - Dual Containment - Decorative  
Applications - Civil Defense - Naval Military Applications -  
Fire Resistive Construction Overview Vinyl Piping Systems

# Material Data: Physical Properties

Table 2-1: Typical physical properties for PVC and CPVC thermoplastic materials in Imperial units

## Mechanical

Properties	Unit	Industrial PVC (Imperial)	Industrial CPVC (Imperial)	ASTM Test
Density	lb/in <sup>3</sup>	0.0506 ± 0.0007	0.0549 ± 0.0007	D-792
Tensile Strength @ 73°F (23°C)	psi	7,200	7,750	D-638
Modulus of Elasticity (E) @ 73°F (23°C)	psi	430,000	360,000	D-638
Compressive Strength (δ) @ 73°F (23°C)	psi	9,500	10,000	D-695
Flexural Strength @ 73°F (23°C)	psi	13,000	13,000	D-790
Flexural Modulus @ 73°F (23°C)	psi	360,000	360,000	D-790
Izod Impact @ 73°F (23°C)	Ft-Lbs/In of Notch	0.75	2.0	D-256
Relative Hardness @ 73°F (23°C)	Rockwell "R"	110-120	117	D-785

## Thermodynamics

Properties	Unit	Industrial PVC (Imperial)	Industrial CPVC (Imperial)	ASTM Test
Coefficient of Thermal Linear Expansion (α)	in/in/°F	2.8 × 10 <sup>-5</sup>	3.7 × 10 <sup>-5</sup>	D-696
Thermal Conductivity	BTU-in/hr-ft <sup>2</sup> -°F	1.30	0.95	C-177
Maximum Operating Temperature	°F	140	200	200
Heat Deflection Temperature @ 264 psi (18 bar)	°F	158	226	D-648

## Other

Properties	Unit	Industrial PVC (Imperial)	Industrial CPVC (Imperial)	ASTM Test
Average Time of Burning	sec.	< 5	< 5	D-635
Average Extent of Burning	in.	< 0.4	< 0.4	D-635
Flame Spread		Not tested	< 25	E-84
Flash Ignition	°F	730	900	
Smoke Generation		Not tested	< 50	
Flammability (0.062 in, 1.57 mm)		V-0	V-0, 5VB, 5VA	UL-94
Softening Starts, approx.	°F	250	295	
Material Becomes Viscous	°F	350	395	
Material Carbonizes	°F	425	450	
Limiting Oxygen Index (LOI)	% Vol.	43	60	D-2863

## Other

Properties	Unit	Industrial PVC (Imperial)	Industrial CPVC (Imperial)	ASTM Test
Water Absorption	%	+0.05 @ 77°F	+0.03 @ 77°F	D-570
Poisson's Ratio @ 73°F (23°C)		0.380	0.386	
ASTM Cell Classification		12454	23447	D-1784
Color		White, Dark Gray	Medium Gray	
NSF Potable Water Approved		Yes	Yes	

Note: This data is based on information compiled from multiple sources.

Table 2-2: Typical physical properties of PVC and CPVC thermoplastic materials in Metric units

## Mechanical

Properties	Unit	Industrial PVC (Metric)	Industrial CPVC (Metric)	ASTM Test
Density	g/cm <sup>3</sup>	1.40 ± 0.02	1.52 ± 0.02	D-792
Tensile Strength @ 73°F (23°C)	MPa	50	53	D-638
Modulus of Elasticity (E) @ 73°F (23°C)	MPa	2970	2480	D-638
Compressive Strength (δ) @ 73°F (23°C)	MPa	65.5	69	D-695
Flexural Strength @ 73°F (23°C)	MPa	90	90	D-790
Flexural Modulus @ 73°F (23°C)	MPa	2500	2500	D-790
Izod Impact @ 73°F (23°C)	m-g/cm of Notch	38	109	D-256
Relative Hardness @ 73°F (23°C)	Rockwell "R"	110-120	117	D-785



## Thermodynamics

Properties	Unit	Industrial PVC (Imperial)	Industrial CPVC (Imperial)	ASTM Test
Coefficient of Thermal Linear Expansion ( $\alpha$ )	in/in°F (mm/mm/°C)	5.1 × 10 <sup>-5</sup>	6.7 × 10 <sup>-5</sup>	D-696
Thermal Conductivity	KCal/m-hr-°C	0.161	0.118	C-177
Maximum Operating Temperature	°C	60	93	200
Heat Deflection Temperature @ 264 psi (18 bar)	°C	70	108	D-648

## Other

Properties	Unit	Industrial PVC (Imperial)	Industrial CPVC (Imperial)	ASTM Test
Average Time of Burning	sec.	< 5	< 5	D-635
Average Extent of Burning	mm	< 10	< 10	D-635
Flame Spread		Not tested	< 25	E-84
Flash Ignition	°C	390	482	
Smoke Generation		Not tested	< 50	
Flammability (0.062 in, 1.57 mm)		V-0	V-0, 5VB, 5VA	UL-94
Softening Starts, approx.	°C	121	146	
Material Becomes Viscous	°C	177	202	
Material Carbonizes	°C	218	232	
Limiting Oxygen Index (LOI)	% Vol.	43	60	D-2863

## Other

Properties	Unit	Industrial PVC (Imperial)	Industrial CPVC (Imperial)	ASTM Test
Water Absorption	%	+0.05 @ 25°C	+0.03 @ 25°C	D-570
Poisson's Ratio @ 73°F (23°C)		0.380	0.386	
ASTM Cell Classification		12454	23447	D-1784
Color		White, Dark Gray	Medium Gray	
NSF Potable Water Approved		Yes	Yes	

Note: This data is based on information compiled from multiple sources.

# Engineering Design

In the engineering of thermoplastic piping systems, it is necessary to have not only a working knowledge of piping design but an awareness of the unique properties of thermoplastics.

Note: The equations in this section give a general idea as to the design of a piping system but do not substitute for the judgement of a licensed engineer.

In addition to chemical resistance, important factors to be considered in designing piping systems employing thermoplastics are:

1. Pressure ratings
2. Water hammer
3. Temperature-pressure relationships
4. Thermal expansion and contraction
5. Friction-loss characteristics

The following sections detail the basic theory and equations associated with each of these factors. Note that unless otherwise specified, all calculations assume an infinitely long pipe, and if a short pipe is being used the calculations may be significantly different. A short pipe varies in definition, but a good rule of thumb is L/D should be greater than 10-50 where L is the length of pipe and D is the outer diameter.

## PVC Schedule Dimension Pipe - Imperial Schedule 40

Nominal Size (inch)	Outside Diameter	Average Inside Diameter	Minimum Wall	Nominal Weight per Foot
1/8	0.405	0.249	0.068	0.051
1/4	0.540	0.344	0.088	0.086
3/8	0.675	0.473	0.091	0.115
1/2	0.840	0.602	0.109	0.170
3/4	1.050	0.804	0.113	0.226
1	1.315	1.029	0.133	0.333
1 1/4	1.660	1.360	0.140	0.450
1 1/2	1.900	1.590	0.145	0.537
2	2.375	2.047	0.154	0.720
2 1/2	2.875	2.445	0.203	1.136
3	3.500	3.042	0.216	1.488
3 1/2	4.000	3.521	0.226	1.789
4	4.500	3.998	0.237	2.118
5	5.563	5.016	0.258	2.874
6	6.625	6.031	0.280	3.733
8	8.625	7.942	0.322	5.619
10	10.750	9.976	0.365	7.966
12	12.750	11.889	0.406	10.534
14	14.000	13.073	0.437	12.462
16	16.000	14.940	0.500	16.286
18	18.000	16.809	0.562	20.587
20	20.000	18.743	0.593	24.183
24	24.000	22.544	0.687	33.652

## Schedule 80

Nominal Size (inch)	Outside Diameter	Average Inside Diameter	Minimum Wall	Nominal Weight per Foot
1/8	0.405	0.195	0.095	0.063
1/4	0.540	0.282	0.119	0.105
3/8	0.675	0.403	0.126	0.146
1/2	0.840	0.526	0.147	0.213
3/4	1.050	0.722	0.154	0.289
1	1.315	0.936	0.179	0.424
1 1/4	1.660	1.255	0.191	0.586
1 1/2	1.900	1.476	0.200	0.711
2	2.375	1.913	0.218	0.984
2 1/2	2.875	2.290	0.276	1.500
3	3.500	2.864	0.300	2.010
3 1/2	4.000	3.326	0.318	2.452
4	4.500	3.786	0.337	2.938
5	5.563	4.768	0.375	4.078
6	6.625	5.709	0.432	5.610
8	8.625	7.565	0.500	8.522
10	10.750	9.493	0.593	12.635
12	12.750	11.294	0.687	17.384
14	14.000	12.410	0.750	20.852
16	16.000	14.213	0.843	26.810
18	18.000	16.014	0.937	33.544
20	20.000	17.814	1.031	41.047
24	24.000	21.418	1.218	58.233

## Schedule 120

Nominal Size (inch)	Outside Diameter	Average Inside Diameter	Minimum Wall	Nominal Weight per Foot
1/2	0.840	0.480	0.170	0.236
3/4	1.050	0.690	0.170	0.311
1	1.315	0.891	0.200	0.464
1 1/4	1.660	1.204	0.215	0.649
1 1/2	1.900	1.423	0.225	0.787
2	2.375	1.845	0.250	1.111
2 1/2	2.875	2.239	0.300	1.615
3	3.500	2.758	0.350	2.306
4	4.500	3.574	0.437	3.713
6	6.625	5.434	0.562	7.132
8	8.625	7.189	0.718	11.27



**PVC Schedule Dimension Pipe**  
**SDR 13.5**

Nominal Size (inch)	Outside Diameter	Average Inside Diameter	Minimum Wall	Nominal Weight per Foot
½	0.840	0.696	0.062	0.110

**SDR 21**

Nominal Size (inch)	Outside Diameter	Average Inside Diameter	Minimum Wall	Nominal Weight per Foot
¾	1.050	0.910	0.060	0.136
1	1.315	1.169	0.063	0.180
1¼	1.660	1.482	0.079	0.278
1½	1.900	1.700	0.090	0.358
2	2.375	2.129	0.113	0.550
2½	2.875	2.581	0.137	0.797
3	3.500	3.146	0.167	1.168
3½	4.000	3.597	0.190	1.520
4	4.500	4.046	0.214	1.927
5	5.563	5.001	0.265	2.948
6	6.625	5.955	0.316	4.185
8	8.625	7.756	0.410	7.069

**SDR 26**

Nominal Size (inch)	Outside Diameter	Average Inside Diameter	Minimum Wall	Nominal Weight per Foot
1	1.315	1.175	0.060	0.173
1¼	1.660	1.512	0.064	0.233
1½	1.900	1.734	0.073	0.300
2	2.375	2.173	0.091	0.456
2½	2.875	2.635	0.110	0.657
3	3.500	3.210	0.135	0.966
3½	4.000	3.672	0.154	1.250
4	4.500	4.134	0.173	1.569
5	5.563	5.108	0.214	2.411
6	6.625	6.084	0.255	3.414
8	8.625	7.921	0.332	5.784
10	10.750	9.874	0.413	8.971
12	12.750	11.711	0.490	12.620
14	14.000	12.860	0.538	15.205
16	16.000	14.696	0.615	19.877
18	18.000	16.533	0.692	25.156
20	20.000	18.370	0.769	31.057
24	24.000	22.043	0.923	44.744

**SDR 41**

Nominal Size (inch)	Outside Diameter	Average Inside Diameter	Minimum Wall	Nominal Weight per Foot
18	18.000	17.070	0.439	15.370
20	20.000	18.970	0.489	18.920
24	24.000	22.748	0.585	27.320

**Pressure Rating**

**Determining Pressure-Stress Pipe Relationships**

The pressure rating of a pipe is determined by the circumferential stress resulting from internal pressure. The pressure rating of a pipe represents the maximum allowable

operating pressure within a piping system for water at 73°F (23°C). The hydrostatic design basis (HDB) is an estimated long-term strength in the circumferential (hoop) direction; for both PVC and CPVC the HDB for long-term calculations is 4000 psi (28 MPa) and the equivalent short-term value is 6400 psi (44 MPa). ASTM requires a safety factor (SF) of 2 for long-term pressures and 3.2 for short-term pressures. The pressure ratings for both PVC and CPVC are listed below. The relationship between maximum allowable internal pressure, circumferential stress, wall thickness, and diameter is governed by the following equations:

**Equation (3-1) - Imperial**

$$P = \frac{1}{SF} \cdot \frac{2 \cdot St}{D_o - t}$$

**Equation (3-2) - Metric**

$$P = \frac{1}{SF} \cdot \frac{20 \cdot St}{D_o - t}$$

Where:

- P = Internal Pressure, psi (bar)
- S = Circumferential Stress, psi (MPa)
- t = Wall Thickness, in. (mm)
- D<sub>o</sub> = Outside Pipe Diameter, in. (mm.)
- SF = Safety Factor

**Equation (3-1) - Imperial Example**

What is the long-term pressure rating of 1" Schedule 80 Industrial PVC Pipe?

**Equation (3-1) - Schedule Long-Term Pressure Rating:**

$$S = 4000 \text{ psi} \quad D_o = 1.315 \text{ in}$$

$$t = 0.179 \text{ in} \quad SF = 2.0$$

$$P = \frac{1}{2.0} \cdot \frac{2 (4000\text{psi})(0.179\text{in})}{1.315\text{in} - 0.179\text{in}}$$

$$P = 630\text{psi}$$

**Equation (3-1) - Schedule Short-Term Pressure Rating:**

$$S = 6400 \text{ psi} \quad D_o = 1.315 \text{ in}$$

$$t = 0.179 \text{ in} \quad SF = 3.2$$

$$P = \frac{1}{3.2} \cdot \frac{2 (6400\text{psi})(0.179\text{in})}{1.315\text{in} - 0.179\text{in}}$$

$$P = 630\text{psi}$$

**Equation (3-2) - Metric Example**

What is the short-term burst pressure rating of 1" Schedule 80 Industrial CPVC Pipe?

**Equation (3-2) - Metric Long-Term Pressure Rating:**

$$S = 27.6 \text{ bar} \quad D_o = 33.40 \text{ mm}$$

$$t = 4.55 \text{ mm} \quad SF = 2.0$$

$$P = \frac{1}{2.0} \cdot \frac{20 (27.6\text{MPa})(4.55\text{mm})}{33.40\text{mm} - 4.55\text{mm}}$$

$$P = 43.4 \text{ bar}$$

### Equation (3-2) - Metric Short-Term Pressure Rating:

$$S = 44.0 \text{ bar} \quad D_o = 33.40 \text{ mm}$$

$$t = 4.55 \text{ mm} \quad SF = 3.2$$

$$P = \frac{1}{3.2} \cdot \frac{20 (44.0 \text{ MPa})(4.55 \text{ mm})}{33.40 \text{ mm} - 4.55 \text{ mm}}$$

$$P = 43.4 \text{ bar}$$

The table below shows the maximum pressure rating results of Equation (3-1) and Equation (3-2) for the PVC and CPVC pipe sizes and schedules available from GF Piping Systems.

**Table 3-2: Maximum pressure rating for all PVC and CPVC pipe at 73°F (23°C) for available sizes and Schedules**

Nominal Size (inch)	Schedule 40		Schedule 80		Schedule 120	
	P (psi)	P (bar)	P (psi)	P (bar)	P (psi)	P (bar)
1/8	810	55.8	1230	84.8	—	—
1/4	780	53.8	1130	77.9	—	—
3/8	620	42.7	920	63.4	—	—
1/2	600	41.4	850	58.6	1010	69.6
3/4	480	33.1	690	47.6	770	53.1
1	450	31.0	630	43.4	720	49.6
1 1/4	370	25.5	520	35.9	600	41.4
1 1/2	330	22.8	470	32.4	540	37.2
2	280	19.3	400	27.6	470	32.4
2 1/2	300	20.7	420	29.0	470	32.4
3	260	17.9	370	25.5	440	30.3
3 1/2	240	16.5	350	24.1	—	—
4	220	15.2	320	22.1	430	29.6
5	190	13.1	290	20.0	—	—
6	180	12.4	280	19.3	370	25.5
8	160	11.0	250	17.2	380	26.2
10	140	9.7	230	15.9	—	—
12	130	9.0	230	15.9	—	—
14	130	9.1	220	15.4	—	—
16	130	9.1	220	15.4	—	—
18	130	9.1	220	15.4	—	—
20	120	8.4	220	15.4	—	—
24	120	8.4	210	14.7	—	—

### Negative Pressures

Critical collapse pressure is the maximum allowable pressure that can be applied externally to a pipe and is directly related to the wall thickness and diameter of the pipe selected. Examples of when external pressure conditions can occur are as follows:

1. When buried pipe is subjected to soil loads
2. Underwater applications
3. Vacuum service
4. Pipe installed on pump suction lines

The actual external load being applied to the pipe is the difference between the external pressure and the internal pressure which counteract each other. Thus, a pressurized pipe can withstand a greater external load than an empty pipe. As implied by the collapse rating, thermoplastic pipe is suitable for vacuum pressure conditions as well. The process

for determining maximum vacuum pressures are the same as for external pressures as negative pressure inside the pipe is equivalent to positive pressure outside the pipe.

**Note: Collapse pressure calculations are for static external pressures only. Dynamic factors are not taken in to account and may cause additional stresses.**

Equation (3-3) and Equation (3-4) below are the basic formulas for calculating critical collapse pressure applied uniformly to a long pipe.

### Equation (3-3) - Imperial

$$P_c = \frac{1}{SF} \cdot \frac{2 \cdot E}{(1 - \nu^2)(D_{ave} / t_{min})^3}$$

### Equation (3-4) - Metric

$$P_c = \frac{1}{SF} \cdot \frac{20 \cdot E}{(1 - \nu^2)(D_{ave} / t_{min})^3}$$

Where:

- $P_c$  = Critical Collapse Pressure, psi (bar)
- $E$  = Modulus of Elasticity, psi (MPa)
- $\nu$  = Poisson's Ratio
- $D_{ave}$  = Average Pipe Diameter, in. (mm)
- $t_{min}$  = Minimum wall thickness, in. (mm)
- SF = Safety factor

### Equation (3-3) - Imperial Examples:

What is the critical collapse pressure for 1" Schedule 80 Industrial PVC Pipe?

### Equation (3-3) - Schedule with no Safety Factor:

$$E = 420,000 \text{ psi} \quad D_{ave} = 1.136 \text{ in} \quad t_{min} = 0.179 \text{ in}$$

$$\nu = 0.41 \quad SF = 1.0$$

$$D_{ave} = 1.315 \text{ in} - 0.179 \text{ in} = 1.136 \text{ in}$$

$$P_c = \frac{1}{1.0} \cdot \frac{2 \cdot 420,000 \text{ psi}}{(1 - 0.41^2)(1.136 \text{ in} / 0.179 \text{ in})^3}$$

$$P_c = 3950 \text{ psi}$$

### Equation (3-3) - Schedule with Safety Factor = 3.0:

$$E = 420,000 \text{ psi} \quad D_{ave} = 1.136 \text{ in} \quad t_{min} = 0.179 \text{ in}$$

$$\nu = 0.41 \quad SF = 3.0$$

$$D_{ave} = 1.315 \text{ in} - 0.179 \text{ in} = 1.136 \text{ in}$$

$$P_c = \frac{1}{3.0} \cdot \frac{2 \cdot 420,000 \text{ psi}}{(1 - 0.41^2)(1.136 \text{ in} / 0.179 \text{ in})^3}$$

$$P_c = 1316 \text{ psi}$$



**Equation (3-4) - Metric Examples:**

What is the short-term burst pressure rating of 1" Schedule 80 Industrial CPVC Pipe?

**Equation (3-4) - Metric with no Safety Factor:**

$$E = 2500\text{MPa} \quad D_{ave} = 28.85\text{mm} \quad t_{min} = 4.55\text{mm}$$

$$\nu = 0.386 \quad SF = 1.0$$

$$D_{ave} = 33.40\text{mm} - 4.55\text{mm} = 28.85\text{mm}$$

$$P_c = \frac{1}{1.0} \cdot \frac{20 \cdot 2500\text{MPa}}{(1 - 0.386^2)(28.85\text{mm} / 4.55\text{mm})^3}$$

$$P_c = 230\text{bar}$$

**Equation (3-4) - Metric with Safety Factor = 3.0:**

$$E = 2500\text{MPa} \quad D_{ave} = 28.85\text{mm} \quad t_{min} = 4.55\text{mm}$$

$$\nu = 0.386 \quad SF = 3.0$$

$$D_{ave} = 1.315\text{in} - 0.179\text{in} = 1.136\text{in}$$

$$P_c = \frac{1}{3.0} \cdot \frac{20 \cdot 2500\text{MPa}}{(1 - 0.386^2)(28.85\text{mm} / 4.55\text{mm})^3}$$

$$P_c = 77\text{bar}$$

Table 3-3, Table 3-4 and Table 3-5 below give the calculated critical collapse pressure with no safety factor. For long term collapse pressures, values should be divided by a safety factor of 2 or 3.

**Table 3-3: Short term collapse pressure for available sizes of Industrial PVC, and Industrial CPVC Schedule 40 pipe at 73°F (23°C)**

Nominal Size (inch)	Industrial PVC		Industrial CPVC	
	P (psi)	P (bar)	P (psi)	P (bar)
1/8	8258	569.4	-	-
1/4	7418	511.4	6244	430.5
3/8	3803	262.2	3201	220.7
1/2	3332	229.8	2805	193.4
3/4	1763	121.6	1484	102.3
1	1432	98.7	1205	83.1
1 1/4	785	54.2	661	45.6
1 1/2	567	39.1	477	32.9
2	335	23.1	282	19.4
2 1/2	441	30.4	371	25.6
3	286	19.7	241	16.6
3 1/2	216	14.9	182	12.5
4	173	11.9	145	10.0
5	116	8.0	97	6.7
6	86	6.0	73	5.0
8	59	4.0	49	3.4
10	44	3.0	37	2.5
12	36	2.5	30	2.1
14	34	2.3	28	2.0
16	34	2.3	28	2.0
18	34	2.3	28	2.0
20	29	2.0	24	1.7
24	26	1.8	22	1.5

**Table 3-4: Short term collapse pressure for available sizes of PVC Schedule 120 pipe at 73°F (23°C)**

Nominal Size (inch)	Industrial PVC	
	P (psi)	P (bar)
1/2	16494	1137.2
3/4	7280	501.9
1	5827	401.8
1 1/4	3326	229.3
1 1/2	2447	168.7
2	1644	113.4
2 1/2	1597	110.1
3	1385	95.5
4	1256	86.6
6	804	55.4
8	756	52.1

GF Piping Systems recommends the use of solvent-cemented connections when using PVC and CPVC piping in vacuum service applications. Threaded connections are not recommended due to the greater potential for leakage when used in negative pressure applications.

**Also, note that external pressures are also subject to temperature derating factors.**

**Table 3-5: Short term collapse pressure for available sizes of Industrial PVC, and Industrial CPVC Schedule 80 pipe at 73°F (23°C)**

Nominal Size (inch)	Industrial PVC		Industrial CPVC	
	P (psi)	P (bar)	P (psi)	P (bar)
1/8	29060	2003.6	-	-
1/4	22804	1572.3	19107	1317.4
3/8	12207	841.6	10228	705.2
1/2	9637	664.5	8075	556.8
3/4	5127	353.5	4296	296.2
1	3950	272.4	3310	228.2
1 1/4	2219	153.0	1860	128.2
1 1/2	1644	113.4	1378	95.0
2	1042	71.9	873	60.2
2 1/2	1209	83.4	1013	69.9
3	832	57.4	697	48.1
3 1/2	650	44.8	545	37.6
4	536	36.9	449	30.9
5	381	26.3	320	22.0
6	343	23.6	287	19.8
8	235	16.2	197	13.6
10	201	13.9	168	11.6
12	187	12.9	156	10.8
14	183	12.6	153	10.6
16	174	12.0	146	10.0
18	167	11.5	140	9.7
20	162	11.2	136	9.4
24	154	10.6	129	8.9

## Surge Pressure (Water Hammer)

Surge pressure, or water hammer, is a term used to describe dynamic surges caused by pressure changes in a piping system. They occur whenever there is a deviation from the steady state, i.e.; when the velocity of the fluid is increased or decreased, and may be transient or oscillating. Waves of positive or negative pressure may be generated by any of the following:

- Opening or closing of a valve
- Pump startup or shutdown
- Change in pump or turbine speed
- Wave action in a feed tank
- Entrapped air

The pressure waves travel along at speeds limited by the speed of sound in the medium, causing the pipe to expand and contract. The energy carried by the wave is dissipated and the waves are progressively damped (see figure below).

The pressure excess to water hammer must be considered in addition to the hydrostatic load, and this total pressure must be sustainable by the piping system. In the case of oscillatory surge pressures, extreme caution is needed as surging at the harmonic frequency of the system could lead to catastrophic damage.

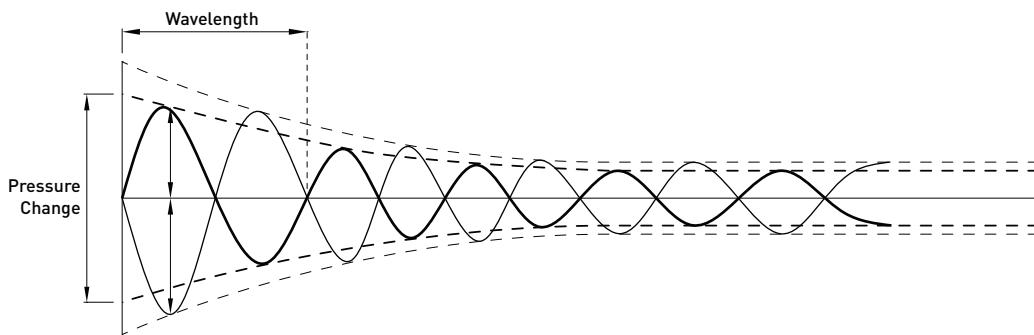

The maximum positive or negative addition of pressure due to surging is a function of fluid velocity, fluid density, bulk fluid density and pipe dimensions of the piping system. It can be calculated using the following steps.

### Step 1

Determine the velocity of the pressure wave in pipes.

- $v_w$  = velocity of pressure wave (ft/s)
- $K$  = bulk modulus of elasticity of fluid (psi)
- $\rho$  = fluid density (slugs/ft<sup>3</sup>)
- $n_i$  = conversion factor 1/144 (ft<sup>2</sup>/in<sup>2</sup>)
- $E$  = modulus of elasticity of pipe wall (psi)
- $d_i$  = pipe inner diameter (inch)
- $e$  = pipe wall thickness (inch)

$$v_w = \sqrt{\frac{K}{\rho \times n_i \left(1 + \frac{K \times d_i}{e \times E}\right)}}$$

### Step 2

Critical time for valve closure.

- $t_c$  = Time for Valve Closure (sec)
- $V_w$  = Velocity of Pressure Wave (ft/sec)
- $L$  = Upstream Pipe Length (ft)

$$t_c = \frac{2L}{V_w}$$

### Step 3

Maximum pressure increase; assume valve closure time is less than the critical closure time and fluid velocity goes to 0.

- $P_i$  = Maximum Total Pressure (lb/in<sup>2</sup>)
- $\delta$  = Fluid Density (slugs/ft<sup>3</sup>)
- $V$  = Fluid Velocity (ft/sec)
- $V_w$  = Velocity of Pressure Wave
- $n_i$  = Conversion Factor 1/144 (ft<sup>2</sup>/in<sup>2</sup>)

$$P_i = \delta \cdot V \cdot V_w \cdot n_i$$

### Special Consideration

Calculate the Maximum Instantaneous System Pressure.

- $P$  = Maximum System Operating Pressure (lb/in<sup>2</sup>)
- $P_i^{\max}$  = Maximum Pressure Increase (lb/in<sup>2</sup>)
- $P_s$  = Standard System Operating Pressure (lb/in<sup>2</sup>)

$$P_{\max} = P_i + P_s$$

**Cautionary Note**

Caution is recommended if  $P_{max}$  is greater than the maximum system design pressure multiplied by a safety factor of 2x. e.g., Pipe is rated at 150 psi. If  $P_{max}$  exceeds 300 psi (150 psi × 2 safety factor), then precaution must be implemented in case of maximum pressure wave (i.e. water hammer) to prevent possible pipe failure.

**Step 4**

Determine the Maximum System Pressure Increase with Gradual Valve Closure

- $P_g$  = Gradual Pressure Increase with Valve Closure (lb/in<sup>2</sup>)
- $L_g$  = Upstream Pipe Length (ft.)
- $V$  = Fluid Velocity (ft./sec)
- $n_i$  = Conversion Factor 1/144 (ft<sup>2</sup>/in<sup>2</sup>)
- $t_v$  = Time of Valve Closure (sec)

$$P_g = \frac{2 \cdot \delta \cdot L \cdot V \cdot n_i}{t_v}$$

**Thrust Blocking**

It is recommended to limit velocities to 5 ft/s (1.5 m/s), especially with larger diameters (6 in and above), and consideration should be given to stresses induced with intermittent pump operation, quick opening stresses induced with intermittent pump operation, quick opening valves, and back flow in elevated discharge lines. Use of bypass piping with electrically actuated time cycle valves or variable speed pumps and check valves on the discharge side are suggested with higher flow rates.

Thrust blocking should be considered for directional changes and pump operations in buried lines 10 in and above, particularly where fabricated fittings are utilized. Above grade installations 10 in and above should have equivalent bracing to simulate thrust blocking at directional changes and for intermittent pump operations. Thrust blocking of directional changes and time cycle valves are also recommended for large diameter drain lines in installations such as large swimming pools and tanks. Use of appropriate pump vibration dampers are also recommended.

The calculation for thrusts due to static internal pressure is below followed by a table of values for the available sizes.

**Equation (3-5) - Imperial**

$$F_T = \frac{D_i^2 \cdot \pi}{4} \cdot P_w C_T$$

**Equation (3-6) - Metric**

$$F_T = \frac{D_i^2 \cdot \pi}{40} \cdot P_w C_T$$

Where:

- $F_T$  = Thrust Force, lb (N)
- $D_i$  = Inner Diameter, in (mm)
- $P_w$  = Working Pressure, psi (bar)
- $C_T$  = Thrust Constant

**Table 3-6: Thrust Constant for various fittings**

Fitting	$C_T$
Tee	1.000
22.5° Ell	0.390
45° Ell	0.764
60° Ell	1.000
90° Ell	1.414
Plugs and Caps	1.000

**Equation (3-5) - Imperial Example**

What is the thrust from static internal pressure of a 1" Schedule 80 Industrial Plus PVC pipe at full working pressure at a 90° ell fitting?

$P_w = 630\text{psi}$        $C_T = 1.414$

$D_i = 1.315\text{in} - 2(0.179\text{in}) = 0.957\text{in}$

$$F_T = \frac{(0.957\text{in})^2 \cdot \pi}{4} \cdot (630\text{psi})(1.414)$$

$F_T = 641\text{lb}$

**Equation (3-6) - Metric Example**

What is the thrust from static internal pressure of a 1" Schedule 80 Industrial CPVC pipe at full working pressure at a 45° ell fitting?

$$P_w = 43.4\text{bar} \quad C_T = 0.764$$

$$D_i = 33.4\text{mm} - 2(4.55\text{mm}) = 24.3\text{mm}$$

$$F_T = \frac{(24.3\text{mm})^2 \cdot \pi}{40} \cdot (43.4\text{bar})(0.764)$$

$$F_T = 1540\text{N}$$

**Equation (3-7) - Imperial/Metric**

$$F_R = D_o \cdot \pi \cdot L_s \cdot T_c \quad (\text{Imperial/Metric Example})$$

Where:

$F_R$  = Joint Resistance to Thrust, lb (N)

$D_o$  = Outside Diameter of Pipe, in (mm)

$L_s$  = Length of Socket, in (mm)

$T_c$  = Shear Strength of Cement Bond psi (MPa)\*

\*Usually at least 300psi (2.1MPa) in a good bond

**Equation (3-7) - Imperial Example**

What is the joint resistance to thrust for a 1" Schedule 80 PVC Industrial Plus pipe at a 90° ell fitting?

$$D_o = 1.315\text{in} \quad L_s = 1.125\text{in} \quad T_c = 300\text{psi}$$

$$F_R = (1.315\text{in}) \cdot \pi \cdot (1.125\text{in}) \cdot (300\text{psi})$$

$$F_R = 1395\text{lbs}$$

**Equation (3-7) - Metric Example**

What is the joint resistance to thrust for a 1" Schedule 80 Industrial CPVC pipe at a 45° ell fitting?

$$D_o = 33.4\text{mm} \quad L_s = 28.6\text{mm} \quad T_c = 2.1\text{MPa}$$

$$F_R = (33.4\text{mm}) \cdot \pi \cdot (28.6\text{mm}) \cdot (2.1\text{MPa})$$

$$F_R = 6302\text{N}$$

**THRUST IN POUNDS  
FROM STATIC INTERNAL PRESSURE**

Size in.	Socket Depth in.	For Plug, 60° Ell Cap Tee	For 22.5° Ell	For 45° Ell	For 90° Ell	Joint Resistant To Thrust	90° Ell Safety Factor
6	6	7,170	2,800	16	16	16	16
8	6	11,240	4,380	16	16	16	16
10	8	16,280	6,350	16	16	16	16
12	8	23,040	8,990	16	16	16	16
14	9	26,610	10,380	16	16	16	16
16	10	34,910	13,620	16	16	16	16
18	12	44,290	17,270	16	16	16	16
20	12	43,410	16,450	16	16	16	16
24	14	61,040	23,810	16	16	16	16



**Table 3-7: Thrust and joint resistance to thrust for Industrial PVC, and Industrial CPVC Schedule 80 Imperial Units**

Thrust (lbs) Size (inch)	Joint Resistant to Thrust (ft/s)	For Tee, Plug, Cap, 60°Ell	For 22.5°Ell	For 45°Ell	For 90°Ell
¼	318	81	32	62	114
⅜	477	129	50	99	183
½	693	199	78	152	281
¾	990	298	116	228	422
1	1,394	453	177	346	641
1¼	1,956	667	260	510	943
1½	2,462	831	324	635	1,174
2	3,358	1,181	461	902	1,670
2½	4,742	1,780	694	1,360	2,517
3	6,185	2,444	953	1,867	3,456
3½	8,011	3,111	1,213	2,377	4,399
4	9,543	3,679	1,435	2,811	5,202
5	13,763	5,276	2,058	4,031	7,461
6	18,732	7,299	2,846	5,576	10,320
8	32,515	11,416	4,452	8,722	16,142
10	50,658	16,523	6,444	12,624	23,364
12	72,100	23,377	9,117	17,860	33,056

**Metric Units**

Thrust (lbs) Size (inch)	Joint Resistant to Thrust (m/s)	For Tee, Plug, Cap, 60°Ell	For 22.5°Ell	For 45°Ell	For 90°Ell
¼	1,415	360	140	275	43,083
⅜	2,123	575	224	440	814
½	3,083	886	345	677	1,252
¾	4,404	1,328	518	1,014	1,877
1	6,205	2,017	786	1,541	2,851
1¼	8,703	2,968	1,158	2,268	4,197
1½	10,957	3,696	1,441	2,824	5,226
2	14,941	5,256	2,050	4,016	7,432
2½	21,101	7,921	3,089	6,052	11,201
3	27,523	10,875	4,241	8,309	15,378
3½	35,649	13,843	5,399	10,576	19,574
4	42,465	16,372	6,385	12,508	23,149
5	61,245	23,479	9,157	17,938	33,199
6	83,356	32,479	12,667	24,814	45,925
8	144,694	50,801	19,812	38,812	71,832
10	225,429	73,529	28,676	56,176	103,970
12	320,843	104,030	40,572	79,479	147,098

**Velocity**

Thermoplastic piping has been successfully installed in systems with a water velocity in excess of 10 ft/s (3 m/s). Thermoplastic pipe is not subject to erosion caused by high velocities and turbulent flow and is superior to metal piping systems in this regard, particularly where corrosive or chemically aggressive fluids are involved. The accepted industry position is that while the maximum safe water velocity in a thermoplastic piping system depends on the specific details of the system and operating conditions, 5 ft/s (1.5 m/s) is considered safe. Higher velocities may be used in systems where the operating characteristics of the valves and pumps are known and sudden changes in flow velocity can be controlled. It is important that the total pressure in the system at any time (operating plus surge or water hammer) not exceed 150% of the pressure rating for the system.

**Entrapped Air**

Entrapped air presents both an important and not well understood factor in piping systems. Systems can develop entrapped air where the fluid enters the system, during the initial filling of the system, through mechanical air releases when the system pressure drops below atmospheric pressure, or from dissolved air in water during large temperature or pressure changes within the system. The entrapped air accumulates at the local high points in the system; this causes a restriction in flow area, causing a larger liquid velocity. The liquid velocity then moves the air packets along the system to an outlet. When the air pocket reaches the outlet, the increased air pressure forces the air out at a high velocity and is then followed by a surge of the transported medium. This causes the equivalent of water hammer and can cause the system to fail.

Entrapped air is not well understood, but the effects can be reduced by filling the system slowly with a fluid velocity of less than 1 ft/s (0.3 m/s) and venting air from high points.

**Cyclic Fatigue**

When discussing water hammer or pressure surge in a piping system, one should also be aware of a failure mode termed cyclic fatigue. Fatigue is caused when a system is exposed to intermittent stresses and can cause failure even when the stresses do not exceed the maximum allowable stress of the system. A piping system that has frequent and significant changes in flow conditions or pressure, creating a fluctuating surge, can effect the structural integrity of a thermoplastic fitting. This condition has been observed in golf course irrigation systems that experience tens of thousands of water pressure surges over the course of a year. The resultant failure from cyclic fatigue is very similar in appearance to long-term static failure, and it may be very difficult to ascertain the exact cause of such failures.

The design engineer should consider the phenomenon when designing a thermoplastic piping system with frequent pressure changes, particularly if the surge pressure exceeds

50% of the system's working pressure. Based on some testing by Keller-Bliesener Engineering, the engineer may want to consider devaluing the fitting by 40% from the published pipe burst pressure. Keeping the flow velocity to 5 ft/s (1.5 m/s) or less will also reduce pressure surges. Other considerations would be to use actuated valves that can be set to provide a slow opening or to install soft-start pumps as both will limit the water hammer and the resultant pressure surges.

## Temperature Effects

### Temperature De-rating

The pressure ratings given are for water, non-shock, @ 73°F. The following temperature de-rating factors are to be applied to the working pressure ratings (W.P.) listed when operating at elevated temperatures.

Multiply the working pressure rating of the selected pipe at 73°F, by the appropriate de-rating factor to determine the maximum working pressure rating of the pipe at the elevated temperature chosen.

Solvent-cemented joints should be utilized when working at or near maximum temperatures of the material selected. GF does not recommend the use of standard threaded connections at temperatures above 110°F for PVC or at temperatures above 150°F for CPVC; use flanged joints or unions where disassembly is necessary at elevated temperatures.

Threading of Schedule 40 pipe (PVC or CPVC) is not a recommended practice due to insufficient wall thickness. Thread only Schedule 80 or heavier walls. Threading requires a 50% reduction in pressure rating stated for plain end pipe @73°F.

Chemical resistance data should be referenced for proper material selection and possible pressure de-rating when working with fluids other than water. Refer to GF Harvel's chemical resistance guide for additional information.

PVC Pipe		CPVC Pipe	
Operating temp (°F)	De-rating factor	Operating temp (°F)	De-rating factor
73	1.00	73-80	1.00
80	0.88	90	0.91
90	0.75	100	0.82
100	0.62	110	0.72
110	0.51	120	0.65
120	0.40	130	0.57
130	0.31	140	0.50
140	0.22	150	0.42
Ex: 10" PVC sch 80 @ 120°F 230 psi × 0.40 = 92 psi max. @ 120°F		160	0.40
		180	0.25
		200	0.20
		Ex: 10" CPVC sch 80 @ 120°F 230 psi × 0.65 = 149.5 psi max. @ 120°F	

### Equation (3-8)

$$P_{OT} = P_{73°F} f$$

Where:

$P_{OT}$  = Pressure at the operating temperature, psi (bar)

$P_{73°F}$  = Pressure at room temperature, psi (bar)

f = Derating factor

The tables show the derated pressures in Imperial and Metric units for the full range of PVC and CPVC piping sizes available from GF Piping Systems.

**Table 3-8: Derated pressures for available sizes of PVC Industrial Schedule 40**

Nominal Size (inch)	Imperial Units								Metric Units								
	Temp. f = s(psi/bar)=	32-73°F	80°F	90°F	100°F	110°F	120°F	130°F	140°F	0-23°C	27°C	32°C	38°C	43°C	49°C	54°C	60°C
		1.00	0.88	0.75	0.62	0.51	0.40	0.31	0.22	1.00	0.88	0.75	0.62	0.51	0.40	0.31	0.22
		2000	1760	1500	1240	1020	800	800	440	138	121	103	86	70	55	55	30
1/8		810	713	608	502	413	324	251	178	55.8	49.1	41.9	34.6	28.5	22.3	17.3	12.3
1/4		780	686	585	484	398	312	242	172	53.8	47.3	40.4	33.4	27.4	21.5	16.7	11.8
3/8		620	546	465	384	316	248	192	136	42.7	37.6	32.0	26.5	21.8	17.1	13.2	9.4
1/2		600	528	450	372	306	240	186	132	41.4	36.4	31.1	25.7	21.1	16.6	12.8	9.1
3/4		480	422	360	298	245	192	149	106	33.1	29.1	24.8	20.5	16.9	13.2	10.3	7.3
1		450	396	338	279	230	180	140	99	31.0	27.3	23.3	19.2	15.8	12.4	9.6	6.8
1 1/4		370	326	278	229	189	148	115	81	25.5	22.4	19.1	15.8	13.0	10.2	7.9	5.6
1 1/2		330	290	248	205	168	132	102	73	22.8	20.1	17.1	14.1	11.6	9.1	7.1	5.0
2		280	246	210	174	143	112	87	62	19.3	17.0	14.5	12.0	9.8	7.7	6.0	4.2
2 1/2		300	264	225	186	153	120	93	66	20.7	18.2	15.5	12.8	10.6	8.3	6.4	4.6
3		260	229	195	161	133	104	81	57	17.9	15.8	13.4	11.1	9.1	7.2	5.5	3.9
3 1/2		240	211	180	149	122	96	74	53	16.5	14.5	12.4	10.2	8.4	6.6	5.1	3.6
4		220	194	165	136	112	88	68	48	15.2	13.4	11.4	9.4	7.8	6.1	4.7	3.3
5		190	167	143	118	97	76	59	42	13.1	11.5	9.8	8.1	6.7	5.2	4.1	2.9
6		180	158	135	112	92	72	56	40	12.4	10.9	9.3	7.7	6.3	5.0	3.8	2.7
8		160	141	120	99	82	64	50	35	11.0	9.7	8.3	6.8	5.6	4.4	3.4	2.4
10		140	123	105	87	71	56	43	31	9.7	8.5	7.3	6.0	4.9	3.9	3.0	2.1
12		130	114	98	81	66	52	40	29	9.0	7.9	6.8	5.6	4.6	3.6	2.8	2.0
14		130	114	98	81	66	52	40	29	9.1	8.0	6.8	5.6	4.6	3.6	2.8	2.0
16		130	114	98	81	66	52	40	29	9.1	8.0	6.8	5.6	4.6	3.6	2.8	2.0
18		130	114	98	81	66	52	40	29	9.1	8.0	6.8	5.6	4.6	3.6	2.8	2.0
20		120	106	90	74	61	48	37	26	8.4	7.4	6.3	5.2	4.3	3.4	2.6	1.8
24		120	106	90	74	61	48	37	26	8.4	7.4	6.3	5.2	4.3	3.4	2.6	1.8

**Table 3-9: Derated pressures for available sizes of Industrial CPVC Schedule 40**

Nominal Size (inch)	Imperial Units											
	Temp. f = s(psi/bar)=	32-73°F	90°F	100°F	110°F	120°F	130°F	140°F	150°F	160°F	180°F	200°F
		1.00	0.88	0.75	0.62	0.51	0.40	0.31	0.22	0.51	0.40	0.31
		2000	1760	1500	1240	1020	800	800	440	1020	800	800
1/4		780	710	640	562	507	445	390	328	312	195	156
3/8		620	564	508	446	403	353	310	260	248	155	124
1/2		600	546	492	432	390	342	300	252	240	150	120
3/4		480	437	394	346	312	274	240	202	192	120	96
1		450	410	369	324	293	257	225	189	180	113	90
1 1/4		370	337	303	266	241	211	185	155	148	93	74
1 1/2		330	300	271	238	215	188	165	139	132	83	66
2		280	255	230	202	182	160	140	118	112	70	56
2 1/2		300	273	246	216	195	171	150	126	120	75	60
3		260	237	213	187	169	148	130	109	104	65	52
3 1/2		240	218	197	173	156	137	120	101	96	60	48
4		220	200	180	158	143	125	110	92	88	55	44
5		190	173	156	137	124	108	95	80	76	48	38
6		180	164	148	130	117	103	90	76	72	45	36
8		160	146	131	115	104	91	80	67	64	40	32
10		140	127	115	101	91	80	70	59	56	35	28
12		130	118	107	94	85	74	65	55	52	33	26
14		130	118	107	94	85	74	65	55	52	33	26
16		130	118	107	94	85	74	65	55	52	33	26
18		130	118	107	94	85	74	65	55	52	33	26
20		120	109	98	86	78	68	60	50	48	30	24
24		120	109	98	86	78	68	60	50	48	30	24

**Table 3-9: Derated pressures for available sizes of Industrial CPVC Schedule 40 - Metric**

Nominal Size (inch)	Metric Units											
	Temp. f = s(psi/bar)=	0-23°C	32°C	38°C	43°C	49°C	54°C	60°C	66°C	71°C	82°C	93°C
		1.00	0.88	0.75	0.62	0.51	0.40	0.31	0.22	0.51	0.40	0.31
		13.8	12.1	10.4	8.6	7.0	5.5	4.3	3.0	7.0	5.5	4.3
¼		53.8	49.0	44.1	38.7	35.0	30.7	26.9	22.6	21.5	13.5	10.8
⅜		42.7	38.9	35.0	30.7	27.8	24.3	21.4	17.9	17.1	10.7	8.5
½		41.4	37.7	33.9	29.8	26.9	23.6	20.7	17.4	16.6	10.4	8.3
¾		33.1	30.1	27.1	23.8	21.5	18.9	16.6	13.9	13.2	8.3	6.6
1		31.0	28.2	25.4	22.3	20.2	17.7	15.5	13.0	12.4	7.8	6.2
1¼		25.5	23.2	20.9	18.4	16.6	14.5	12.8	10.7	10.2	6.4	5.1
1½		22.8	20.7	18.7	16.4	14.8	13.0	11.4	9.6	9.1	5.7	4.6
2		19.3	17.6	15.8	13.9	12.5	11.0	9.7	8.1	7.7	4.8	3.9
2½		20.7	18.8	17.0	14.9	13.5	11.8	10.4	8.7	8.3	5.2	4.1
3		17.9	16.3	14.7	12.9	11.6	10.2	9.0	7.5	7.2	4.5	3.6
3½		16.5	15.0	13.5	11.9	10.7	9.4	8.3	6.9	6.6	4.1	3.3
4		15.2	13.8	12.5	10.9	9.9	8.7	7.6	6.4	6.1	3.8	3.0
5		13.1	11.9	10.7	9.4	8.5	7.5	6.6	5.5	5.2	3.3	2.6
6		12.4	11.3	10.2	8.9	8.1	7.1	6.2	5.2	5.0	3.1	2.5
8		11.0	10.0	9.0	7.9	7.2	6.3	5.5	4.6	4.4	2.8	2.2
10		9.7	8.8	8.0	7.0	6.3	5.5	4.9	4.1	3.9	2.4	1.9
12		9.0	8.2	7.4	6.5	5.9	5.1	4.5	3.8	3.6	2.3	1.8
14		9.1	8.3	7.5	6.6	5.9	5.2	4.6	3.8	3.6	2.3	1.8
16		9.1	8.3	7.5	6.6	5.9	5.2	4.6	3.8	3.6	2.3	1.8
18		9.1	8.3	7.5	6.6	5.9	5.2	4.6	3.8	3.6	2.3	1.8
20		8.4	7.6	6.9	6.0	5.5	4.8	4.2	3.5	3.4	2.1	1.7
24		8.4	7.6	6.9	6.0	5.5	4.8	4.2	3.5	3.4	2.1	1.7

**Table 3-10: Derated pressures for available sizes of Industrial PVC Schedule 80**

Nominal Size (inch)	Imperial Units								Metric Units								
	Temp. f = s(psi/bar)=	32-73°F	80°F	90°F	100°F	110°F	120°F	130°F	140°F	0-23°C	27°C	32°C	38°C	43°C	49°C	54°C	60°C
		1.00	0.88	0.75	0.62	0.51	0.40	0.31	0.22	1.00	0.88	0.75	0.62	0.51	0.40	0.31	0.22
		2000	1760	1500	1240	1020	800	800	440	13.8	12.1	10.4	8.6	7.0	5.5	4.3	3.0
⅛		1230	1082	923	763	627	492	381	271	84.8	74.6	63.6	52.6	43.2	33.9	26.3	18.7
¼		1130	994	848	701	576	452	350	249	77.9	68.6	58.4	48.3	39.7	31.2	24.1	17.1
⅜		920	810	690	570	469	368	285	202	63.4	55.8	47.6	39.3	32.3	25.4	19.7	13.9
½		850	748	638	527	434	340	264	187	58.6	51.6	44.0	36.3	29.9	23.4	18.2	12.9
¾		690	607	518	428	352	276	214	152	47.6	41.9	35.7	29.5	24.3	19.0	14.8	10.5
1		630	554	473	391	321	252	195	139	43.4	38.2	32.6	26.9	22.1	17.4	13.5	9.5
1¼		520	458	390	322	265	208	161	114	35.9	31.6	26.9	22.3	18.3	14.4	11.1	7.9
1½		470	414	353	291	240	188	146	103	32.4	28.5	24.3	20.1	16.5	13.0	10.0	7.1
2		400	352	300	248	204	160	124	88	27.6	24.3	20.7	17.1	14.1	11.0	8.6	6.1
2½		420	370	315	260	214	168	130	92	29.0	25.5	21.8	18.0	14.8	11.6	9.0	6.4
3		370	326	278	229	189	148	115	81	25.5	22.4	19.1	15.8	13.0	10.2	7.9	5.6
3½		350	308	263	217	179	140	109	77	24.1	21.2	18.1	14.9	12.3	9.6	7.5	5.3
4		320	282	240	198	163	128	99	70	22.1	19.4	16.6	13.7	11.3	8.8	6.9	4.9
5		290	255	218	180	148	116	90	64	20.0	17.6	15.0	12.4	10.2	8.0	6.2	4.4
6		280	246	210	174	143	112	87	62	19.3	17.0	14.5	12.0	9.8	7.7	6.0	4.2
8		250	220	188	155	128	100	78	55	17.2	15.1	12.9	10.7	8.8	6.9	5.3	3.8
10		230	202	173	143	117	92	71	51	15.9	14.0	11.9	9.9	8.1	6.4	4.9	3.5
12		230	202	173	143	117	92	71	51	15.9	14.0	11.9	9.9	8.1	6.4	4.9	3.5
14		220	194	165	136	112	88	68	48	15.4	13.6	11.6	9.5	7.9	6.2	4.8	3.4
16		220	194	165	136	112	88	68	48	15.4	13.6	11.6	9.5	7.9	6.2	4.8	3.4
18		220	194	165	136	112	88	68	48	15.4	13.6	11.6	9.5	7.9	6.2	4.8	3.4
20		220	194	165	136	112	88	68	48	15.4	13.6	11.6	9.5	7.9	6.2	4.8	3.4
24		210	185	158	130	107	84	65	46	14.7	12.9	11.0	9.1	7.5	5.9	4.6	3.2



**Table 3-11: Derated pressures for available sizes of Industrial CPVC Schedule 80**

Nominal Size (inch)	Imperial Units											
	Temp. f = s(psi/bar)=	32-73°F	90°F	100°F	110°F	120°F	130°F	140°F	150°F	160°F	180°F	200°F
		1.00	0.88	0.75	0.62	0.51	0.40	0.31	0.22	0.51	0.40	0.31
		2000	1760	1500	1240	1020	800	800	440	1020	800	800
¼		1130	1028	927	814	735	644	565	475	452	283	226
⅜		920	837	754	662	598	524	460	386	368	230	184
½		850	774	697	612	553	485	425	357	340	213	170
¾		690	628	566	497	449	393	345	290	276	173	138
1		630	573	517	454	410	359	315	265	252	158	126
1¼		520	473	426	374	338	296	260	218	208	130	104
1½		470	428	385	338	306	268	235	197	188	118	94
2		400	364	328	288	260	228	200	168	160	100	80
2½		420	382	344	302	273	239	210	176	168	105	84
3		370	337	303	266	241	211	185	155	148	93	74
3½		350	319	287	252	228	200	175	147	140	88	70
4		320	291	262	230	208	182	160	134	128	80	64
5		290	264	238	209	189	165	145	122	116	73	58
6		280	255	230	202	182	160	140	118	112	70	56
8		250	228	205	180	163	143	125	105	100	63	50
10		230	209	189	166	150	131	115	97	92	58	46
12		230	209	189	166	150	131	115	97	92	58	46
14		220	200	180	158	143	125	110	92	88	55	44
16		220	200	180	158	143	125	110	92	88	55	44
18		220	200	180	158	143	125	110	92	88	55	44
20		220	200	180	158	143	125	110	92	88	55	44
24		210	191	172	151	137	120	105	88	84	53	42

**Table 3-11: Derated pressures for available sizes of Industrial CPVC Schedule 80 - Metric**

Nominal Size (inch)	Metric Units											
	Temp. f = s(psi/bar)=	0-23°C	32°C	38°C	43°C	49°C	54°C	60°C	66°C	71°C	82°C	93°C
		1.00	0.88	0.75	0.62	0.51	0.40	0.31	0.22	0.51	0.40	0.31
		13.8	12.1	10.4	8.6	7.0	5.5	4.3	3.0	7.0	5.5	4.3
¼		77.9	70.9	63.9	56.1	50.6	44.4	39.0	32.7	31.2	19.5	15.6
⅜		63.4	57.7	52.0	45.6	41.2	36.1	31.7	26.6	25.4	15.9	12.7
½		58.6	53.3	48.1	42.2	38.1	33.4	29.3	24.6	23.4	14.7	11.7
¾		47.6	43.3	39.0	34.3	30.9	27.1	23.8	20.0	19.0	11.9	9.5
1		43.4	39.5	35.6	31.2	28.2	24.7	21.7	18.2	17.4	10.9	8.7
1¼		35.9	32.7	29.4	25.8	23.3	20.5	18.0	15.1	14.4	9.0	7.2
1½		32.4	29.5	26.6	23.3	21.1	18.5	16.2	13.6	13.0	8.1	6.5
2		27.6	25.1	22.6	19.9	17.9	15.7	13.8	11.6	11.0	6.9	5.5
2½		29.0	26.4	23.8	20.9	18.9	16.5	14.5	12.2	11.6	7.3	5.8
3		25.5	23.2	20.9	18.4	16.6	14.5	12.8	10.7	10.2	6.4	5.1
3½		24.1	21.9	19.8	17.4	15.7	13.7	12.1	10.1	9.6	6.0	4.8
4		22.1	20.1	18.1	15.9	14.4	12.6	11.1	9.3	8.8	5.5	4.4
5		20.0	18.2	16.4	14.4	13.0	11.4	10.0	8.4	8.0	5.0	4.0
6		19.3	17.6	15.8	13.9	12.5	11.0	9.7	8.1	7.7	4.8	3.9
8		17.2	15.7	14.1	12.4	11.2	9.8	8.6	7.2	6.9	4.3	3.4
10		15.9	14.5	13.0	11.4	10.3	9.1	8.0	6.7	6.4	4.0	3.2
12		15.9	14.5	13.0	11.4	10.3	9.1	8.0	6.7	6.4	4.0	3.2
14		15.4	14.0	12.6	11.1	10.0	8.8	7.7	6.5	6.2	3.9	3.1
16		15.4	14.0	12.6	11.1	10.0	8.8	7.7	6.5	6.2	3.9	3.1
18		15.4	14.0	12.6	11.1	10.0	8.8	7.7	6.5	6.2	3.9	3.1
20		15.4	14.0	12.6	11.1	10.0	8.8	7.7	6.5	6.2	3.9	3.1
24		14.7	13.4	12.1	10.6	9.6	8.4	7.4	6.2	5.9	3.7	2.9

**Table 3-12: Derated pressures for available sizes of Industrial PVC Schedule 120**

Nominal Size (inch)	Imperial Units								Metric Units							
	Temp.	32-73°F	80°F	90°F	100°F	110°F	120°F	130°F	140°F	0-23°C	27°C	32°C	38°C	43°C	49°C	54°C
f =	1.00	0.88	0.75	0.62	0.51	0.40	0.31	0.22	1.00	0.88	0.75	0.62	0.51	0.40	0.31	0.22
s (psi/bar)=	2000	1760	1500	1240	1020	800	800	440	13.8	12.1	10.4	8.6	7.0	5.5	4.3	3.0
½	1010	889	758	626	515	404	313	222	69.6	61.2	52.2	43.2	35.5	27.8	21.6	15.3
¾	770	678	578	477	393	308	239	169	53.1	46.7	39.8	32.9	27.1	21.2	16.5	11.7
1	720	634	540	446	367	288	223	158	49.6	43.6	37.2	30.8	25.3	19.8	15.4	10.9
1¼	600	528	450	372	306	240	186	132	41.4	36.4	31.1	25.7	21.1	16.6	12.8	9.1
1½	540	475	405	335	275	216	167	119	37.2	32.7	27.9	23.1	19.0	14.9	11.5	8.2
2	470	414	353	291	240	188	146	103	32.4	28.5	24.3	20.1	16.5	13.0	10.0	7.1
2½	470	414	353	291	240	188	146	103	32.4	28.5	24.3	20.1	16.5	13.0	10.0	7.1
3	440	387	330	273	224	176	136	97	30.3	26.7	22.7	18.8	15.5	12.1	9.4	6.7
4	430	378	323	267	219	172	133	95	29.6	26.0	22.2	18.4	15.1	11.8	9.2	6.5
6	370	326	278	229	189	148	115	81	25.5	22.4	19.1	15.8	13.0	10.2	7.9	5.6
8	380	334	285	236	194	152	118	84	26.2	23.1	19.7	16.2	13.4	10.5	8.1	5.8

Solvent-cemented joints should be utilized when working at or near maximum temperatures of the material selected. GF Piping Systems does not recommend the use of standard threaded connections at temperatures above 110°F (43°C) for PVC or at temperatures above 150°F (66°C) for CPVC; use specialty reinforced adapters, flanged joints, unions or roll grooved couplings where disassembly is necessary at elevated temperatures.

Threaded, Schedule 40 pipe (PVC and CPVC) is not recommended practice due to insufficient wall thickness. Thread only Schedule 80 or heavier walls. Threading requires a 50% reduction in pressure rating stated for plain end pipe at 73°F (23°C).

**Chemical resistance data should be referenced for proper material selection and possible pressure derating when working with fluids other than water. Refer to Georg Fischer's online chemical resistance guide (<http://gfps.com/chemres>) for additional information.**

### Thermal Expansion and Contraction

All piping systems expand and contract with changes in temperature. Thermoplastics exhibit a relatively high coefficient of thermal expansion that can be as much as ten times that of steel. The issue must be addressed with appropriate system design to prevent damage to the piping system. The degree of movement (change in length) generated as the result of temperature changes must be calculated based on the type of piping material and the anticipated temperature changes of the system. The rate of expansion does not vary with pipe size. In many cases this movement must then be compensated for by the construction of appropriate sized expansion loops, offsets, or bends or the installation of expansion joints.

If designed improperly, expansion and contraction can cause unnecessary bending stresses in the piping system. The above described configurations will absorb the stresses generated from the movement, thereby minimizing damage to the piping. The effects of thermal expansion and contraction must be considered during the design phase, particularly for systems involving long runs, hot water lines, hot drain lines, and piping

systems exposed to environmental temperature extremes (i.e. summer to winter).

Thermal expansion can be evaluated using Equation (3-9) and values are illustrated in Table 3-13 and Table 3-14.

#### Calculating Linear Movement Caused by Thermal Expansion

The rate of movement (change in length) caused by thermal expansion or contraction can be calculated as follows:

##### Equation (3-9)

$$\Delta L = 12yl(\Delta T)$$

**Where:**

$\Delta L$  = expansion or contraction in inches

y = Coefficient of linear expansion of piping material selected

l = length of piping run in feet

$\Delta T$  = (T1 -T2) temperature change °F

**Where:**

T1= maximum service temperature of system and

T2 = temperature at time of installation (or difference between lowest system temperature and maximum system temperature – whichever is greatest )

##### Equation (3-9) - Imperial Example

**Example 1:** Calculate the change in length for a 100 foot straight run of 2" Schedule 80 PVC pipe operating at a temperature of 73°F; installed at 32°F.

$$\Delta L = 12yl(DT)$$

**Where:**

$\Delta L$  = linear expansion or contraction in inches

y = 2.9 x 10<sup>-5</sup> in/in/°F

l = 100ft

$\Delta T$  = 41 °F (73°F – 32°F)

$$\Delta L = 12 \text{ in/ft} \times 0.000029 \text{ in/in/ft} \times 100\text{ft} \times 41 \text{ °F}$$

$$\Delta L = 1.43"$$

In this example the piping would expand approximately 1 1/2" in length over a 100 ft straight run once the operating temperature of 73°F was obtained.

<b>Coefficient of Linear Expansion (y) of Various GF Harvel Piping Products (in/in/°F) per ASTM D696</b>	
<b>Pipe Material</b>	<b>y</b>
GF Harvel PVC Pressure Pipe (all schedules & SDR's) and PVC Duct	$2.9 \times 10^{-5}$
GF Harvel CPVC Schedule 40 & Schedule 80 Pressure Pipe	$3.7 \times 10^{-5}$
GF Harvel CPVC Duct	$3.9 \times 10^{-5}$
GF Harvel CTS CPVC Plumbing Pipe	$3.2 \times 10^{-5}$
GF Harvel Clear PVC Schedule 40 & Schedule 80 Pipe	$4.1 \times 10^{-5}$
GF Harvel LXT UPW P	$3.9 \times 10^{-5}$

Note: Refer to appropriate physical Properties Tables for additional detailed information

**Table 3-13: Thermal expansion of Industrial PVC, all schedules**

<b>Imperial Units (inch)</b>																		
<b>Change in Temperature (°F)</b>	<b>Length of Pipe (Ft)</b>																	
	<b>10</b>	<b>20</b>	<b>30</b>	<b>40</b>	<b>50</b>	<b>60</b>	<b>70</b>	<b>80</b>	<b>90</b>	<b>100</b>	<b>125</b>	<b>150</b>	<b>175</b>	<b>200</b>	<b>250</b>	<b>300</b>	<b>350</b>	<b>400</b>
10	0.03	0.07	0.10	0.13	0.17	0.20	0.24	0.27	0.30	0.34	0.42	0.50	0.59	0.67	0.84	1.01	1.18	1.34
20	0.07	0.13	0.20	0.27	0.34	0.40	0.47	0.54	0.60	0.67	0.84	1.01	1.18	1.34	1.68	2.02	2.35	2.69
30	0.10	0.20	0.30	0.40	0.50	0.60	0.71	0.81	0.91	1.01	1.26	1.51	1.76	2.02	2.52	3.02	3.53	4.03
40	0.13	0.27	0.40	0.54	0.67	0.81	0.94	1.08	1.21	1.34	1.68	2.02	2.35	2.69	3.36	4.03	4.70	5.38
50	0.17	0.34	0.50	0.67	0.84	1.01	1.18	1.34	1.51	1.68	2.10	2.52	2.94	3.36	4.20	5.04	5.88	6.72
60	0.20	0.40	0.60	0.81	1.01	1.21	1.41	1.61	1.81	2.02	2.52	3.02	3.53	4.03	5.04	6.05	7.06	8.06
70	0.24	0.47	0.71	0.94	1.18	1.41	1.65	1.88	2.12	2.35	2.94	3.53	4.12	4.70	5.88	7.06	8.23	9.41
80	0.27	0.54	0.81	1.08	1.34	1.61	1.88	2.15	2.42	2.69	3.36	4.03	4.70	5.38	6.72	8.06	9.41	10.75
90	0.30	0.60	0.91	1.21	1.51	1.81	2.12	2.42	2.72	3.02	3.78	4.54	5.29	6.05	7.56	9.07	10.58	12.10
100	0.34	0.67	1.01	1.34	1.68	2.02	2.35	2.69	3.02	3.36	4.20	5.04	5.88	6.72	8.40	10.08	11.76	13.44

<b>Metric Units (mm)</b>																		
<b>Change in Temperature (°C)</b>	<b>Length of Pipe (m)</b>																	
	<b>5</b>	<b>10</b>	<b>15</b>	<b>20</b>	<b>25</b>	<b>30</b>	<b>35</b>	<b>40</b>	<b>45</b>	<b>50</b>	<b>60</b>	<b>70</b>	<b>80</b>	<b>90</b>	<b>100</b>	<b>110</b>	<b>120</b>	<b>130</b>
5	1	3	4	5	6	8	9	10	11	13	15	18	20	23	26	28	31	33
10	3	5	8	10	13	15	18	20	23	26	31	36	41	46	51	56	61	66
15	4	8	11	15	19	23	27	31	34	38	46	54	61	69	77	84	92	99
20	5	10	15	20	26	31	36	41	46	51	61	71	82	92	102	112	122	133
25	6	13	19	26	32	38	45	51	57	64	77	89	102	115	128	140	153	166
30	8	15	23	31	38	46	54	61	69	77	92	107	122	138	153	168	184	199
35	9	18	27	36	45	54	62	71	80	89	107	125	143	161	179	196	214	232
40	10	20	31	41	51	61	71	82	92	102	122	143	163	184	204	224	245	265
45	11	23	34	46	57	69	80	92	103	115	138	161	184	207	230	252	275	298
50	13	26	38	51	64	77	89	102	115	128	153	179	204	230	255	281	306	332

**Table 3-14: Thermal expansion of Industrial CPVC, all schedules**

<b>Imperial Units (inch)</b>																		
<b>Change in Temperature (°F)</b>	<b>Length of Pipe (Ft)</b>																	
	<b>10</b>	<b>20</b>	<b>30</b>	<b>40</b>	<b>50</b>	<b>60</b>	<b>70</b>	<b>80</b>	<b>90</b>	<b>100</b>	<b>125</b>	<b>150</b>	<b>175</b>	<b>200</b>	<b>250</b>	<b>300</b>	<b>350</b>	<b>400</b>
10	0.04	0.09	0.13	0.18	0.22	0.27	0.31	0.36	0.40	0.44	0.56	0.67	0.78	0.89	1.11	1.33	1.55	1.78
20	0.09	0.18	0.27	0.36	0.44	0.53	0.62	0.71	0.80	0.89	1.11	1.33	1.55	1.78	2.22	2.66	3.11	3.55
30	0.13	0.27	0.40	0.53	0.67	0.80	0.93	1.07	1.20	1.33	1.67	2.00	2.33	2.66	3.33	4.00	4.66	5.33
40	0.18	0.36	0.53	0.71	0.89	1.07	1.24	1.42	1.60	1.78	2.22	2.66	3.11	3.55	4.44	5.33	6.22	7.10
50	0.22	0.44	0.67	0.89	1.11	1.33	1.55	1.78	2.00	2.22	2.78	3.33	3.89	4.44	5.55	6.66	7.77	8.88
60	0.27	0.53	0.80	1.07	1.33	1.60	1.86	2.13	2.40	2.66	3.33	4.00	4.66	5.33	6.66	7.99	9.32	10.66
70	0.31	0.62	0.93	1.24	1.55	1.86	2.18	2.49	2.80	3.11	3.89	4.66	5.44	6.22	7.77	9.32	10.88	12.43
80	0.36	0.71	1.07	1.42	1.78	2.13	2.49	2.84	3.20	3.55	4.44	5.33	6.22	7.10	8.88	10.66	12.43	14.21
90	0.40	0.80	1.20	1.60	2.00	2.40	2.80	3.20	3.60	4.00	5.00	5.99	6.99	7.99	9.99	11.99	13.99	15.98
100	0.44	0.89	1.33	1.78	2.22	2.66	3.11	3.55	4.00	4.44	5.55	6.66	7.77	8.88	11.10	13.32	15.54	17.76

<b>Metric Units (mm)</b>																		
<b>Change in Temperature (°C)</b>	<b>Length of Pipe (m)</b>																	
	<b>5</b>	<b>10</b>	<b>15</b>	<b>20</b>	<b>25</b>	<b>30</b>	<b>35</b>	<b>40</b>	<b>45</b>	<b>50</b>	<b>60</b>	<b>70</b>	<b>80</b>	<b>90</b>	<b>100</b>	<b>110</b>	<b>120</b>	<b>130</b>
5	2	3	5	7	8	10	12	13	15	17	20	23	27	30	34	37	40	44
10	3	7	10	13	17	20	23	27	30	34	40	47	54	60	67	74	80	87
15	5	10	15	20	25	30	35	40	45	50	60	70	80	90	101	111	121	131
20	7	13	20	27	34	40	47	54	60	67	80	94	107	121	134	147	161	174
25	8	17	25	34	42	50	59	67	75	84	101	117	134	151	168	184	201	218
30	10	20	30	40	50	60	70	80	90	101	121	141	161	181	201	221	241	261
35	12	23	35	47	59	70	82	94	106	117	141	164	188	211	235	258	281	305
40	13	27	40	54	67	80	94	107	121	134	161	188	214	241	268	295	322	348
45	15	30	45	60	75	90	106	121	136	151	181	211	241	271	302	332	362	392
50	17	34	50	67	84	101	117	134	151	168	201	235	268	302	335	369	402	436

**Expansion Control**

In most piping applications, the effects of thermal expansion/contraction are usually absorbed by the system in changes of direction in the piping. However, long, straight runs of piping are more susceptible to experiencing measurable movement with changes in temperature.

**Thermal Stress**

Compressive stress is generated in piping that is restrained from expanding in cases where the effects of thermal expansion are not addressed. This induced stress can damage the piping system leading to premature failure and in some cases also cause damage to hangers, supports, or other structural members.

The amount of compressive stress generated is dependent on the pipe material, coefficient of thermal expansion, and tensile modulus and can be determined by the following equation:



**Equation (3-10)**

$S = E\alpha\Delta T$  (Imperial and Metric)

Where:

S = Thermal stress introduced in the pipe, psi (MPa)

E = Change in length due to thermal expansion, in (mm)

$\alpha$  = Maximum change in temperature between installation and operation, °F (°C)

$\Delta T$  = Coefficient of thermal expansion, in/in-°F (mm/mm-°C)

**Equation (3-10) - Imperial Example**

What is the thermal stress of a 1" Schedule 80 CPVC pipe installed at 80°F and operating at 180°F?

$E = 420,000 \text{ psi}$

$\Delta T = 180 \text{ }^\circ\text{F} - 80 \text{ }^\circ\text{F} = 100 \text{ }^\circ\text{F}$

$\alpha = 2.9 \times 10^{-5} \text{ in/in-}^\circ\text{F}$

$S = (420,000 \text{ psi})(2.9 \times 10^{-5} \text{ in/in-}^\circ\text{F}) \times (4200 \text{ in}) \times (100 \text{ }^\circ\text{F})$

$S = 1220 \text{ psi}$

**Equation (3-10) - Metric Example**

What is the thermal stress of a 1" Schedule 80 CPVC pipe installed at 23°C and operating at 50°C?

$L = 2480 \text{ MPa}$

$\Delta T = 50^\circ\text{C} - 23^\circ\text{C} = 27 \text{ }^\circ\text{C}$

$\alpha = 6.7 \times 10^{-5} \text{ in/in-}^\circ\text{C}$

$S = (2480 \text{ MPa}) \times (6.7 \times 10^{-5} \text{ in/in-}^\circ\text{C}) \times (27 \text{ }^\circ\text{C})$

$S = 4.5 \text{ MPa}$

The stress induced in the pipe as a result of thermal influences must not exceed the maximum allowable working stress of the pipe material. The maximum allowable working stress (fiber stress) is dependent on the temperature the pipe is exposed to. Increases in temperature will reduce the allowable stress as shown in Table 3-15 and Table 3-16.

**Table 3-15: Maximum allowable working (fiber) stress and tensile modulus at various temperatures for Industrial PVC**

Temperature (°F)	Temperature (°C)	Maximum Allowable Working (Fiber) Stress (psi)	Maximum Allowable Working (Fiber) Stress (MPa)	Tensile Modulus of Elasticity (psi)	Tensile Modulus of Elasticity (Mpa)
73	23	2,000	13.79	420,000	2,896
80	27	1,760	12.14	369,600	2,548
90	32	1,500	10.34	315,000	2,172
100	38	1,240	8.55	260,400	1,796
110	43	1,020	7.03	214,200	1,477
120	49	800	5.52	168,000	1,158
130	54	620	4.27	130,200	898
140	60	440	3.03	92,400	637

**Table 3-16: Maximum allowable working (fiber) stress and tensile modulus at various temperatures for Industrial CPVC**

Temperature (°F)	Temperature (°C)	Maximum Allowable Working (Fiber) Stress (psi)	Maximum Allowable Working (Fiber) Stress (MPa)	Tensile Modulus of Elasticity (psi)	Tensile Modulus of Elasticity (Mpa)
73	23	2,000	13.79	420,000	2,896
80	27	1,760	12.14	369,600	2,548
90	32	1,500	10.34	315,000	2,172
100	38	1,240	8.55	260,400	1,796
110	43	1,020	7.03	214,200	1,477
120	49	800	5.52	168,000	1,158
130	54	620	4.27	130,200	898
140	60	440	3.03	92,400	637

## Compensating for Movement Caused by Thermal Expansion and Contraction

As with other piping materials, the installation of expansion joints, expansion loops or offsets is required on long, straight runs. This will allow the piping system to absorb the forces generated by expansion and contraction without damage. Examples are shown in Figure 3-1.

**Figure 3-1: Expansion loop, offset, and change in direction.**

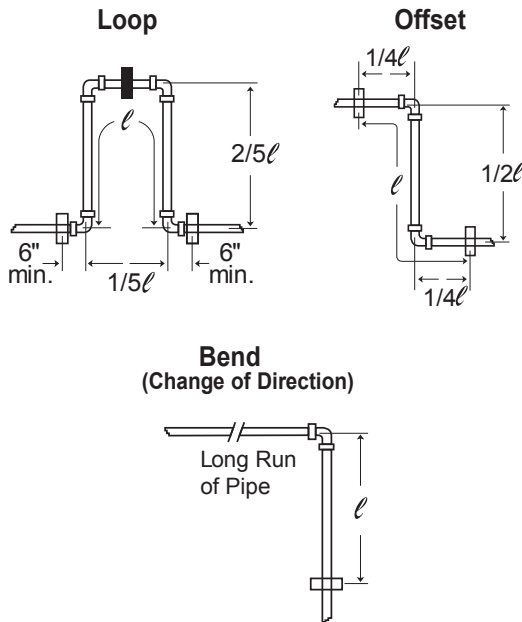

Once the change in length ( $\Delta L$ ) has been determined, the length of an offset, expansion loop, or bend required to compensate for this change can be calculated as follows:

### Equation (3-11) - Imperial/Metric:

$$\ell = \sqrt{\frac{3E D_{ave} \Delta L}{2S}} \quad (10)$$

Where:

- $\ell$  = Compensated expansion length, in. (mm)
- $E$  = Modulus of elasticity, psi (MPa)
- $D_{ave}$  = Average outside diameter of pipe, in. (mm)
- $\Delta L$  = Change in length of pipe due to temperature change, in. (mm)
- $S$  = Thermal stress at maximum temperature, psi (MPa)

### Equation (3-11) - Imperial Example

What is the minimum sizing of an expansion loop for 1" Schedule 80 CPVC pipe installed at 80°F and operating at 180°F, and with a  $\Delta L$  of 4"?

- $E = 360,000$  psi
- $D_{ave} = 1.136$  in.
- $\Delta L = 4$ "
- $S = 500$  psi

$$\ell = \sqrt{\frac{3(360,000 \text{ psi})(1.136 \text{ in})(4 \text{ in})}{2(500 \text{ psi})}}$$

$$\ell = 70 \text{ in} \quad \frac{3}{5}\ell = 28 \text{ in} \quad \frac{1}{5}\ell = 14 \text{ in}$$

### Equation (3-11) - Metric Example

What is the minimum sizing of a bend for 1" Schedule 80 CPVC pipe installed at 23°C and operating at 43°C, and with a  $\Delta L$  of 100 mm?

- $E = 2500$  MPa
- $D_{ave} = 28.85$  mm
- $\Delta L = 100$  mm
- $S = 10.3$  MPa

$$\ell = \sqrt{\frac{3(2500 \text{ MPa})(28.85 \text{ mm})(100 \text{ mm})}{2(10.3 \text{ MPa})}}$$

$$\ell = 1025 \text{ mm} = 1.03 \text{ m}$$

Hangers or guides should only be placed in the loop, offset, or change of direction as indicated above, and they must not compress or restrict the pipe from axial movement. Piping supports should restrict lateral movement and should direct axial movement into the expansion loop configuration. Do not restrain change in direction configurations by butting up against joists, studs, walls, or other structures. Use only solvent-cemented connections on straight pipe lengths, in combination with 90° elbows, to construct the expansion loop, offset, or bend. The use of threaded components to construct the loop configuration is not recommended.

Expansion loops, offsets, and bends should be installed as nearly as possible to the midpoint between anchors. Concentrated loads, such as valves, should not be installed in the developed length. Calculated support guide spacing distances for offsets and bends must not exceed recommended hanger support spacing for the maximum anticipated temperature. If this occurs, the distance between anchors must be reduced until the support guide spacing distance is less than or equal to the maximum recommended support spacing distance for the appropriate pipe size at the temperature used. All valve support should not restrict movement.

### Expansion Joints

Expansion joints are necessary when standard expansion loops are not practical or not desired. Expansion joints allow for rigid mounting between two fixed points with the inner tube expanding and contracting, like a piston, against the anchored outer tube. Expansion joints are an effective means of designing for expansion or contraction and should be the preferred consideration when

1. The system has critical dimensions with no room for movement (i.e. manifold systems),
2. The system has significant space constraints (i.e. containment piping systems),
3. The system will experience frequent thermal cycling,
4. The system will be exposed to a temperature change beyond 30°F (17°C), or
5. Physical appearance is critical.

Normally expansion joints are not necessary indoors unless the temperature of the air and/or liquid is going to vary. Outdoor installations need to consider expansion and

contraction. The amount of expansion is based on the temperature differential between the minimum and maximum of the air and/or liquid.

GF expansion joints are available in 6 in and 12 in piston lengths. Table 3-17 and Table 3-18 give the pressure ratings of the expansion joints depending on pipe diameter and temperature. Equation (3-12) will assist in the determination of piston position during installation.

**Note that the thermal expansion equation in Section 3.2.2 is used to determine the minimum piston length.**

**Caution: Do not test with air or air over water.**

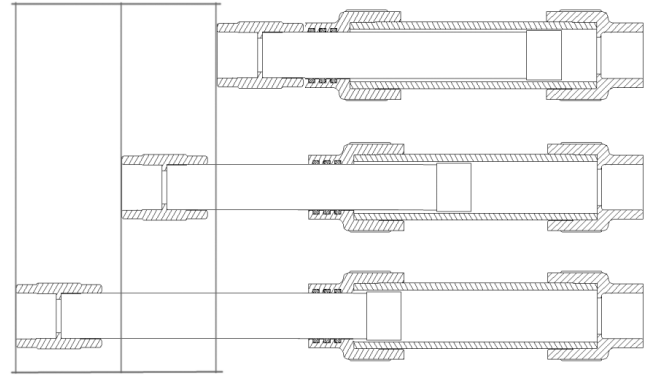

**Figure 3-2: Piston position for expansion joint.**

**Table 3-17: Expansion joint pressure ratings for Industrial PVC**

Max. Pressure	73°F	100°F	120°F	140°F	23°C	38°C	49°C	60°C
½"	340	260	170	95	23.4	17.9	11.7	6.6
¾"	340	210	140	75	23.4	14.5	9.7	5.2
1"	320	200	130	70	22.1	13.8	9.0	4.8
1¼"	260	165	105	60	17.9	11.4	7.2	4.1
1½"	240	150	100	55	16.5	10.3	6.9	3.8
2"	200	125	80	45	13.8	8.6	5.5	3.1
3"	190	120	75	42	13.1	8.3	5.2	2.9
4"	160	100	65	40	11.0	6.9	4.5	2.8
6"	130	100	55	30	9.0	6.9	3.8	2.1
8"	130	100	55	30	9.0	6.9	3.8	2.1
10"	130	100	55	30	9.0	6.9	3.8	2.1

**Table 3-18: Expansion joint pressure ratings for Industrial CPVC.**

Max. Pressure	73°F	120°F	140°F	160°F	180°F	23°C	49°C	60°C	71°C	82°C
½"	340	275	215	170	110	23.4	19.0	14.8	11.7	7.6
¾"	340	225	170	135	85	23.4	15.5	11.7	9.3	5.9
1"	320	205	160	125	80	22.1	14.1	11.0	8.6	5.5
1¼"	260	170	130	105	65	17.9	11.7	9.0	7.2	4.5
1½"	240	150	120	95	60	16.5	10.3	8.3	6.6	4.1
2"	200	130	100	80	50	13.8	9.0	6.9	5.5	3.4
3"	190	125	95	75	50	13.1	8.6	6.6	5.2	3.4
4"	160	105	80	65	40	11.0	7.2	5.5	4.5	2.8
6"	130	90	70	50	36	9.0	6.2	4.8	3.4	2.5
8"	130	90	70	50	36	9.0	6.2	4.8	3.4	2.5
10"	130	90	70	50	36	9.0	6.2	4.8	3.4	2.5

**Equation (3-12) - Imperial/Metric**

$$P_x = \frac{T_{max} - T_{amb}}{T_{amb} - T_{min}} \Delta X$$

Where:  
 $P_x$  = Piston position at time of installation, in (mm)  
 $T_{max}$  = Temperature maximum, °F (°C)  
 $T_{amb}$  = Temperature ambient, °F (°C)  
 $T_{min}$  = Temperature minimum, °F (°C)  
 $\Delta X$  = Piston Length, in (mm)

$$T_{min} = 50^\circ F \quad T_{max} = 90^\circ F \quad T_{amb} = 60^\circ F$$

$$L = 300ft \times 12in/ft = 3600in$$

$$\alpha = 3.7 \times 10^{-5}in/in-^\circ F$$

$$\Delta T = 90^\circ F - 50^\circ F = 40^\circ F$$

$$\Delta L = (3.7 \times 10^{-5}in/in-^\circ F)(3600in)(40^\circ F)$$

$$\Delta L = 5.3in \rightarrow \Delta x = 6in$$

**Equation (3-12) - Imperial Example**

What is the required piston length and installation position of a 1" Schedule 80 CPVC expansion joint when the ambient temperature is 60°F, maximum temperature is 90°F, and the minimum temperature is 50°F? The pipe run is 300 feet long.

$$P_x = \frac{90^\circ F - 60^\circ F}{60^\circ F - 50^\circ F} \times 6in$$

$$P_x = 4.5in$$

### Equation (3-12) - Metric Example

What is the required piston length and installation position of a 1" Schedule 80 CPVC expansion joint when the ambient temperature is 23°C, maximum temperature is 32°C, and the minimum temperature is 15°C? The pipe run is 150 m long.

$$T_{min} = 15^{\circ}\text{C} \quad T_{max} = 32^{\circ}\text{C} \quad T_{amb} = 23^{\circ}\text{C}$$

$$L = 150\text{m} \times 1000\text{mm/m} = 150,000\text{mm}$$

$$\alpha = 6.7 \times 10^{-5}\text{mm/mm-}^{\circ}\text{C}$$

$$\Delta T = 32^{\circ}\text{C} - 15^{\circ}\text{C} = 17^{\circ}\text{C}$$

$$\Delta L = (6.7 \times 10^{-5}\text{mm/mm-}^{\circ}\text{C})(150,000\text{mm})(17^{\circ}\text{C})$$

$$\Delta L = 170.9\text{mm} \rightarrow \Delta x = 304.8\text{mm}$$

$$P_x = \frac{32^{\circ}\text{C} - 23^{\circ}\text{C}}{32^{\circ}\text{C} - 15^{\circ}\text{C}} \times 304.8\text{mm}$$

$$P_x = 161.4\text{mm}$$

### Thermal Conductivity

One of the benefits to using thermoplastic piping is its ability to act as a thermal insulator. The heat transfer coefficient, a constant describing the ability of a material to transfer heat, is significantly lower than that of metal piping. This reduces the condensation production on the outside of the piping; condensation can cause issues with electrical equipment, cause corrosion, and present a safety hazard. A lower heat transfer coefficient also allows the transported fluid to retain heat, or lack thereof, leading to smaller temperature changes throughout the system. Equation (3-13) demonstrates the calculations for heat flux.

### Equation (3-13) - Imperial/Metric

$$q = \frac{2\pi K L \Delta T}{\ln(D_o/D_i)}$$

Where:

- q = Heat gain (negative values = heat loss, BTU/hr (W))
- K = Thermal conductivity of pipe, BTU/hr°F ft (W/°C m)
- L = Length of pipe, ft (m)
- D<sub>o</sub> = Outside diameter, in (mm)
- D<sub>i</sub> = Inside diameter, in (mm)
- T<sub>amb</sub> = Temperature ambient, °F (°C)
- T<sub>i</sub> = Temperature fluid, °F (°C)
- ΔT = T<sub>amb</sub> - T<sub>i</sub>, °F (°C)
- ln(x) = Natural Log of x

### Equation (3-13) - Imperial Example

What is the heat gain (loss) of a 1" Schedule 80 CPVC pipe, 100ft long, where the fluid temperature is 180°F and the ambient temperature is 75°F?

$$L = 100\text{ft}$$

$$D_o = 1.315\text{in}$$

$$D_i = 0.957\text{in}$$

$$T_{amb} = 75^{\circ}\text{F}$$

$$T_i = 180^{\circ}\text{F}$$

$$\Delta T = 75^{\circ}\text{F} - 180^{\circ}\text{F} = -105^{\circ}\text{F}$$

$$K = 0.079 \text{ BTU/hr-}^{\circ}\text{F ft}$$

$$q = \frac{2\pi(0.079 \text{ BTU/hr-}^{\circ}\text{F ft})(100\text{ft})(-105^{\circ}\text{F})}{\ln(1.315\text{in}/0.957\text{in})}$$

$$P_x = -16400 \text{ BTU/hr (heat loss)}$$

### Equation (3-13) - Metric Example

What is the heat gain (loss) of a 1" Schedule 80 SeaCor pipe, 100m long, where the fluid temperature is 10°C and the ambient temperature is 25°C?

$$L = 100\text{m}$$

$$D_o = 33.4\text{mm}$$

$$D_i = 24.3\text{mm}$$

$$T_{amb} = 25^{\circ}\text{C}$$

$$T_i = 10^{\circ}\text{C}$$

$$\Delta T = 25^{\circ}\text{C} - 10^{\circ}\text{C} = 15^{\circ}\text{C}$$

$$K = 0.138 \text{ W/}^{\circ}\text{C m}$$

$$q = \frac{2\pi(0.138 \text{ W/}^{\circ}\text{C m})(100\text{m})(15^{\circ}\text{C})}{\ln(33.4\text{mm}/24.3\text{mm})}$$

$$P_x = 4088 \text{ W (heat gain)}$$

Thermal conductivity coefficients are listed Table 3-19. Equation (3-13) is to be used as a general estimate of heat flux. More complicated systems will also need to evaluate heat flux based on:

1. A more accurate heat transfer coefficient
2. Fluid conductivity
3. Fluid heat capacity
4. Viscosity
5. Air temperature
6. Air velocity

**Table 3-19: Coefficients of thermal conductivity for various materials**

Material	K (BTU/hr°F ft)	K (W/°C m)
Industrial PVC	0.108	0.187
Industrial CPVC	0.079	0.137
Carbon Steel	21-31	36-54
Cast Iron	32	55
Copper	222	385
Stainless Steel	9.4-14	16.3-24
FRP	0.13-0.61	0.23-1.06
Polyethylene	0.24-0.29	0.42-0.51

### Friction Loss

A major advantage of thermoplastic pipe is its exceptionally smooth inside surface, which reduces friction loss compared to other materials. Friction loss in thermoplastic pipe remains constant over extended periods of time in contrast to many traditional materials where the value of the Hazen and Williams C factor (constant for inside roughness) decreases with time.

### C Factors

The relationship between a material's C factor and inside roughness is such that the higher the C factor, the smoother the surface. Tests made both with new pipe and pipe that had been in service revealed C factor values for thermoplastic pipe between 160 and 165; thus, the factor of 150 recommended for water is on the conservative side. On the other hand, the C factor for metallic pipe varies from 65 to 125 depending upon age and interior roughening. A benefit with thermoplastic piping



is that it is often possible to achieve the desired flow rate using a smaller diameter pipe, resulting in less initial cost for pipe, valves, fittings, and pumps and still maintaining the same, or even lower, friction losses. A long-term benefit would be the resultant savings in energy required to operate the system.

### Hazen and Williams Formula

The head losses resulting from various water flow rates in thermoplastic piping may be calculated by means of the Hazen and Williams equation below, assuming a value of 150 for C:

#### Equation (3-14) - Imperial

$$f = 0.0983 \frac{Q^{1.852}}{D_i^{4.8655}}$$

#### Equation (3-15) - Metric

$$f = 56962 \frac{Q^{1.852}}{D_i^{4.8655}}$$

Where:  
 $f$  = Friction head in ft. (m) of water per 100 ft. (100m) of pipe  
 $D_i$  = Inside pipe diameter, in. (mm)  
 $Q$  = Flow rate, gal/min (L/min)

#### Equation (3-14) - Imperial Example

What is the head loss for 50 ft of 1" Schedule 80 CPVC at a flow rate of 5 gal/minute?

$$Q = 5 \text{ gal/min}$$

$$D_i = 1.315 \text{ in} - 2(0.179) = 0.957 \text{ in}$$

$$f = 0.0983 \frac{(5 \text{ gal/min})^{1.852}}{(0.957 \text{ in})^{4.8655}}$$

$$f = 2.40 \text{ (ft/100ft)}$$

$$f = 1.20 \text{ (ft/50ft)}$$

#### Equation (3-15) - Metric Example

What is the head loss for 200 m of 1" Schedule 80 CPVC at a flow rate of 10 l/minute?

$$Q = 10 \text{ l/min}$$

$$D_i = 33.40 \text{ mm} - 2(4.55 \text{ mm}) = 24.3 \text{ mm}$$

$$f = 56962 \frac{(10 \text{ l/min})^{1.852}}{(24.3 \text{ mm})^{4.8655}}$$

$$f = 0.734 \text{ (m/100m)}$$

$$f = 1.468 \text{ (m/200m)}$$

Pressure losses are generally described in psi (bar) for calculations. Equation (3-18) and Equation (3-19) give the conversions from head loss to pressure loss for water.

#### Equation (3-16) - Imperial

$$P = 0.4335f$$

#### Equation (3-17) - Metric

$$P = 0.980f$$

Where:

$$P = \text{Pressure loss per 100ft (100m) of pipe, psi (bar)}$$

#### Equation (3-16) - Imperial Example

What is the pressure loss per 100 ft of pipe if the head loss is 2ft/100ft of pipe?

$$f = 2 \text{ ft/100ft of pipe}$$

$$P = 0.4335 (2 \text{ ft/100ft})$$

$$P = 0.867 \text{ psi/100ft}$$

#### Equation (3-17) - Metric Example

What is the pressure loss per 100 m of pipe if the head loss is 0.1m/100m of pipe?

$$f = 0.1 \text{ m/100m of pipe}$$

$$P = 0.980 (0.1 \text{ m/100m})$$

$$P = 0.0196 \text{ bar/100m}$$

### Friction Loss

Carrying capacity, friction loss, and flow data for the various schedules of thermoplastic pipe are presented in tabular form in the following tables. These tables are applicable to pipe made of either PVC or CPVC as they have equally smooth interior surfaces.



Table 3-20: Friction loss for Industrial PVC, and Industrial CPVC Schedule 40 in Imperial units (1½ in - 6in)

Gallons per minute	1½ in ID = 1.61in			2 in ID = 2.067in			2½ in ID = 2.469in			3 in ID = 3.068in			3½ in ID = 3.548in			4 in ID = 4.026in			5 in ID = 5.047in			6 in ID = 6.065in			
	Friction Loss (psi/100 ft)	Friction Loss (ft/100 ft)	Velocity (ft/s)	Friction Loss (psi/100 ft)	Friction Loss (ft/100 ft)	Velocity (ft/s)	Friction Loss (psi/100 ft)	Friction Loss (ft/100 ft)	Velocity (ft/s)	Friction Loss (psi/100 ft)	Friction Loss (ft/100 ft)	Velocity (ft/s)	Friction Loss (psi/100 ft)	Friction Loss (ft/100 ft)	Velocity (ft/s)	Friction Loss (psi/100 ft)	Friction Loss (ft/100 ft)	Velocity (ft/s)	Friction Loss (psi/100 ft)	Friction Loss (ft/100 ft)	Velocity (ft/s)	Friction Loss (psi/100 ft)	Friction Loss (ft/100 ft)	Velocity (ft/s)	
1	0.16	0.01	0.00																						
2	0.31	0.03	0.02	0.13	0.00	0.00																			
5	0.78	0.19	0.08	0.33	0.02	0.01	0.21	0.01	0.00																
7	1.09	0.36	0.15	0.46	0.04	0.02	0.30	0.02	0.01	0.22	0.01	0.00													
10	1.56	0.69	0.30	0.66	0.09	0.04	0.43	0.03	0.01	0.32	0.01	0.01	0.25	0.01	0.00										
15	2.33	1.46	0.63	0.99	0.18	0.08	0.64	0.06	0.03	0.48	0.03	0.01	0.37	0.02	0.01	0.24	0.01	0.00							
20	3.11	2.49	1.08	1.32	0.31	0.13	0.86	0.11	0.05	0.64	0.05	0.02	0.50	0.03	0.01	0.32	0.01	0.00							
25	3.89	3.76	1.63	1.65	0.47	0.20	1.07	0.16	0.07	0.80	0.08	0.03	0.62	0.04	0.02	0.40	0.01	0.01	0.27	0.01	0.00				
30	4.67	5.27	2.28	1.99	0.66	0.29	1.29	0.23	0.10	0.96	0.11	0.05	0.75	0.06	0.03	0.48	0.02	0.01	0.33	0.01	0.00				
35	5.45	7.01	3.04	2.32	0.88	0.38	1.50	0.30	0.13	1.12	0.15	0.07	0.87	0.08	0.04	0.55	0.03	0.01	0.38	0.01	0.00				
40	6.22	8.98	3.89	2.65	1.12	0.49	1.71	0.39	0.17	1.28	0.19	0.08	1.00	0.10	0.05	0.63	0.03	0.01	0.44	0.01	0.01				
45	7.00	11.17	4.84	2.98	1.39	0.60	1.93	0.48	0.21	1.44	0.24	0.10	1.12	0.13	0.06	0.71	0.04	0.02	0.49	0.02	0.01				
50	7.78	13.57	5.88	3.31	1.70	0.73	2.14	0.59	0.26	1.60	0.29	0.13	1.24	0.16	0.07	0.79	0.05	0.02	0.55	0.02	0.01				
55	8.56	16.20	7.02	3.64	2.02	0.88	2.36	0.70	0.30	1.76	0.35	0.15	1.37	0.19	0.08	0.87	0.06	0.03	0.60	0.03	0.01				
60	9.34	19.03	8.25	3.97	2.38	1.03	2.57	0.83	0.36	1.92	0.41	0.18	1.49	0.22	0.10	0.95	0.07	0.03	0.66	0.03	0.01				
65	10.11	22.07	9.57	4.30	2.76	1.19	2.79	0.96	0.42	2.08	0.47	0.20	1.62	0.26	0.11	1.03	0.09	0.04	0.71	0.03	0.02				
70	10.89	25.31	10.97	4.63	3.16	1.37	3.00	1.10	0.48	2.24	0.54	0.23	1.74	0.29	0.13	1.11	0.10	0.04	0.77	0.04	0.02				
75				4.96	3.59	1.56	3.21	1.25	0.54	2.40	0.62	0.27	1.87	0.33	0.14	1.19	0.11	0.05	0.82	0.05	0.02				
80				5.29	4.05	1.75	3.43	1.41	0.61	2.56	0.69	0.30	1.99	0.38	0.16	1.27	0.12	0.05	0.88	0.05	0.02				
90				5.96	5.03	2.18	3.86	1.75	0.76	2.88	0.86	0.37	2.24	0.47	0.20	1.43	0.16	0.07	0.99	0.06	0.03				
100				6.62	6.12	2.65	4.29	2.13	0.92	3.20	1.05	0.45	2.49	0.57	0.25	1.58	0.19	0.08	1.10	0.08	0.03				
125				8.27	9.25	4.01	5.36	3.22	1.39	4.01	1.59	0.69	3.11	0.86	0.37	1.98	0.29	0.12	1.37	0.12	0.05				
150				9.93	12.97	5.62	6.43	4.51	1.95	4.81	2.22	0.96	3.73	1.20	0.52	2.38	0.40	0.17	1.64	0.16	0.07				
175				11.58	17.25	7.48	7.50	6.00	2.60	5.61	2.96	1.28	4.35	1.60	0.69	2.77	0.53	0.23	1.92	0.22	0.09				
200							8.57	7.68	3.33	6.41	3.79	1.64	4.98	2.05	0.89	3.17	0.68	0.30	2.19	0.28	0.12				
250							10.71	11.61	5.03	8.01	5.72	2.48	6.22	3.09	1.34	3.96	1.03	0.45	2.74	0.42	0.18				
300										9.61	8.02	3.48	7.47	4.34	1.88	4.75	1.44	0.63	3.29	0.59	0.26				
350										11.21	10.67	4.63	8.71	5.77	2.50	5.54	1.92	0.83	3.84	0.79	0.34				
400													9.95	7.39	3.20	6.33	2.46	1.07	4.39	1.01	0.44				
450													11.20	9.19	3.98	7.13	3.06	1.33	4.93	1.25	0.54				
500																7.92	3.72	1.61	5.48	1.52	0.66				
750																11.88	7.88	3.42	8.22	3.22	1.40				
800																			8.77	3.63	1.57				
1000																			10.97	5.49	2.38				

Table 3-20: Friction loss for Industrial PVC, and Industrial CPVC Schedule 40 in Imperial units (8in -24in)

Gallons per minute	8 in			10 in			12 in			14 in			16 in			18 in			20 in			24 in		
	Velocity (ft/s)	Friction Loss (ft/100 ft)	Friction Loss (psi/100 ft)	Velocity (ft/s)	Friction Loss (ft/100 ft)	Friction Loss (psi/100 ft)	Velocity (ft/s)	Friction Loss (ft/100 ft)	Friction Loss (psi/100 ft)	Velocity (ft/s)	Friction Loss (ft/100 ft)	Friction Loss (psi/100 ft)	Velocity (ft/s)	Friction Loss (ft/100 ft)	Friction Loss (psi/100 ft)	Velocity (ft/s)	Friction Loss (ft/100 ft)	Friction Loss (psi/100 ft)	Velocity (ft/s)	Friction Loss (ft/100 ft)	Friction Loss (psi/100 ft)			
75	7.981	10.02	11.938	13.126	15.000	16.876	18.814	22.626	0.01	0.00	0.00	0.00	0.00	0.00	0.00	0.00	0.00	0.00	0.00	0.00	0.00			
80	0.47	0.01	0.01	0.32	0.00	0.00	0.23	0.00	0.00	0.25	0.00	0.00	0.21	0.00	0.00	0.25	0.00	0.00	0.20	0.00	0.00			
80	0.51	0.01	0.01	0.36	0.01	0.00	0.25	0.00	0.00	0.25	0.00	0.00	0.21	0.00	0.00	0.25	0.00	0.00	0.20	0.00	0.00			
90	0.57	0.02	0.01	0.36	0.01	0.00	0.28	0.00	0.00	0.28	0.00	0.00	0.23	0.00	0.00	0.28	0.00	0.00	0.23	0.00	0.00			
100	0.63	0.02	0.01	0.40	0.01	0.00	0.29	0.00	0.00	0.31	0.00	0.00	0.23	0.00	0.00	0.31	0.00	0.00	0.23	0.00	0.00			
125	0.79	0.03	0.01	0.50	0.01	0.00	0.35	0.00	0.00	0.36	0.00	0.00	0.29	0.00	0.00	0.36	0.00	0.00	0.28	0.00	0.00			
150	0.95	0.04	0.02	0.60	0.01	0.00	0.42	0.01	0.00	0.45	0.01	0.00	0.35	0.00	0.00	0.42	0.00	0.00	0.34	0.00	0.00			
175	1.11	0.06	0.02	0.70	0.02	0.01	0.50	0.01	0.00	0.47	0.01	0.00	0.41	0.01	0.00	0.47	0.01	0.00	0.40	0.00	0.00			
200	1.27	0.07	0.03	0.80	0.02	0.01	0.57	0.01	0.00	0.47	0.01	0.00	0.41	0.01	0.00	0.47	0.01	0.00	0.40	0.00	0.00			
250	1.58	0.11	0.05	1.00	0.04	0.02	0.71	0.02	0.01	0.59	0.01	0.00	0.45	0.01	0.00	0.59	0.01	0.00	0.42	0.00	0.00			
300	1.90	0.16	0.07	1.21	0.05	0.02	0.85	0.02	0.01	0.70	0.01	0.00	0.54	0.01	0.00	0.70	0.01	0.00	0.42	0.00	0.00			
350	2.22	0.21	0.09	1.41	0.07	0.03	0.99	0.03	0.01	0.82	0.02	0.01	0.63	0.01	0.00	0.82	0.02	0.01	0.40	0.00	0.00			
400	2.53	0.26	0.11	1.61	0.09	0.04	1.13	0.04	0.02	0.94	0.02	0.01	0.72	0.01	0.01	0.94	0.02	0.01	0.46	0.00	0.00			
450	2.85	0.33	0.14	1.81	0.11	0.05	1.27	0.05	0.02	1.05	0.03	0.01	0.81	0.02	0.01	1.05	0.03	0.01	0.51	0.01	0.00			
500	3.17	0.40	0.17	2.01	0.13	0.06	1.42	0.06	0.02	1.17	0.04	0.02	0.90	0.02	0.01	1.17	0.04	0.02	0.57	0.01	0.00			
750	4.75	0.85	0.37	3.01	0.28	0.12	2.12	0.12	0.05	1.76	0.08	0.03	1.34	0.04	0.02	1.76	0.08	0.03	0.85	0.01	0.01			
1000	6.33	1.44	0.63	4.02	0.48	0.21	2.83	0.20	0.09	2.34	0.13	0.06	1.79	0.07	0.03	2.34	0.13	0.06	1.14	0.02	0.01			
1250	7.92	2.18	0.95	5.02	0.72	0.31	3.54	0.31	0.13	2.93	0.19	0.08	2.24	0.10	0.04	2.93	0.19	0.08	1.42	0.03	0.01			
1500	9.50	3.06	1.33	6.03	1.01	0.44	4.25	0.43	0.19	3.51	0.27	0.12	2.69	0.14	0.06	3.51	0.27	0.12	1.71	0.05	0.02			
1750	11.08	4.07	1.76	7.03	1.35	0.58	4.95	0.57	0.25	4.10	0.36	0.16	3.14	0.19	0.08	4.10	0.36	0.16	1.99	0.06	0.03			
2000				8.04	1.72	0.75	5.66	0.73	0.32	4.68	0.46	0.20	3.59	0.24	0.10	4.68	0.46	0.20	2.28	0.08	0.03			
2500				10.04	2.61	1.13	7.08	1.11	0.48	5.85	0.70	0.30	4.48	0.37	0.16	5.85	0.70	0.30	2.85	0.12	0.05			
3000							8.49	1.56	0.68	7.02	0.98	0.43	5.38	0.51	0.22	7.02	0.98	0.43	3.42	0.17	0.07			
3500							9.91	2.07	0.90	8.19	1.31	0.57	6.27	0.68	0.30	8.19	1.31	0.57	3.99	0.23	0.10			
4000							11.32	2.65	1.15	9.36	1.67	0.72	7.17	0.87	0.38	9.36	1.67	0.72	4.56	0.29	0.13			
4500										10.54	2.08	0.90	8.07	1.09	0.47	10.54	2.08	0.90	5.13	0.36	0.16			
5000													8.96	1.32	0.57	8.96	1.32	0.57	5.70	0.44	0.19			
5500													9.86	1.58	0.68	9.86	1.58	0.68	6.27	0.52	0.23			
6000													10.76	1.85	0.80	10.76	1.85	0.80	6.84	0.61	0.27			
6500																			7.41	0.71	0.31			
7000																			7.98	0.82	0.35			
7500																			8.55	0.93	0.40			
8000																			9.12	1.05	0.45			
9000																			10.26	1.30	0.56			
10000																								
12000																								
14000																								

Table 3-21: Friction loss for Industrial PVC, and Industrial CPVC Schedule 40 in Metric units (1/8 in - 1 1/4 in)

Flow Rate (L/min)	1/8 in			1/4 in			3/8 in			1/2 in			3/4 in			1 in			1 1/4 in		
	Friction Loss (bar/100 m)	Friction Loss (m/100 m)	Velocity (cm/s)	Friction Loss (bar/100 m)	Friction Loss (m/100 m)	Velocity (cm/s)	Friction Loss (bar/100 m)	Friction Loss (m/100 m)	Velocity (cm/s)	Friction Loss (bar/100 m)	Friction Loss (m/100 m)	Velocity (cm/s)	Friction Loss (bar/100 m)	Friction Loss (m/100 m)	Velocity (cm/s)	Friction Loss (bar/100 m)	Friction Loss (m/100 m)	Velocity (cm/s)	Friction Loss (bar/100 m)	Friction Loss (m/100 m)	Velocity (cm/s)
1	11.4	5.0	4.9	6.2	1.1	1.1	3.4	0.3	0.3	2.1	0.1	0.1	1.2	0.0	0.0	0.7	0.0	0.0	0.0	0.0	35.1
5	56.8	97.6	95.6	31.0	22.4	22.0	16.9	5.1	5.0	10.6	1.7	1.6	6.1	0.4	0.4	3.7	0.1	0.1	0.1	0.0	2.2
10	113.6	352.3	345.2	62.1	80.9	79.3	33.8	18.5	18.1	21.3	6.0	5.8	12.1	1.5	1.5	7.5	0.5	0.5	0.1	0.1	4.3
15	170.5	746.5	731.6	93.1	171.4	167.9	50.8	39.2	38.4	31.9	12.6	12.4	18.2	3.2	3.2	11.2	1.0	1.0	0.3	0.3	6.5
30	340.9	2694.9	2641.0	186.2	618.7	606.3	101.5	141.4	138.6	63.8	45.6	44.7	36.3	11.6	11.4	22.4	3.6	3.5	0.9	0.9	13.0
50				310.3	1593.4	1561.5	169.2	364.2	356.9	106.3	117.5	115.2	60.6	29.9	29.3	37.4	9.2	9.1	2.4	2.4	21.6
75							253.8	771.7	756.2	159.4	249.1	244.1	90.8	63.4	62.1	56.0	19.6	19.2	5.1	5.1	32.4
100							338.3	1314.7	1288.4	212.5	424.3	415.8	121.1	108.0	105.8	74.7	33.4	32.7	8.6	8.6	43.2
125										265.7	641.4	628.6	151.4	163.3	160.0	93.4	50.4	49.4	13.0	13.0	54.0
150										318.8	899.1	881.1	181.7	228.8	224.3	112.1	70.7	69.3	18.2	18.2	64.8
175													211.9	304.5	298.4	130.8	94.1	92.2	24.3	24.3	75.6
200													242.2	389.9	382.1	149.5	120.4	118.0	31.1	31.1	86.4
225													272.5	484.9	475.2	168.1	149.8	146.8	38.7	38.7	97.2
250													302.8	589.4	577.6	186.8	182.1	178.4	47.0	47.0	107.9
275													333.1	703.2	689.1	205.5	217.2	212.9	56.1	56.1	118.7
300																224.2	255.2	250.1	65.9	65.9	129.5
325																242.9	296.0	290.1	76.4	76.4	140.3
350																261.6	339.5	332.8	87.6	87.6	151.1
400																298.9	434.8	426.1	112.2	112.2	172.7
450																336.3	540.8	530.0	139.6	139.6	194.3
500																			169.6	169.6	215.9
600																			237.8	237.8	259.1
700																			316.3	316.3	302.3
800																			405.1	405.1	345.4



Table 3-21: Friction loss for Industrial PVC, and Industrial CPVC Schedule 40 in Metric units (1 1/2 in - 6 in)

Flow Rate (L/min)	1 1/2 in			2 in			2 1/2 in			3 in			3 1/2 in			4 in			5 in			6 in		
	Velocity (cm/s)	Friction Loss (m/100 m)	Friction Loss (bar/100 m)	Velocity (cm/s)	Friction Loss (m/100 m)	Friction Loss (bar/100 m)	Velocity (cm/s)	Friction Loss (m/100 m)	Friction Loss (bar/100 m)	Velocity (cm/s)	Friction Loss (m/100 m)	Friction Loss (bar/100 m)	Velocity (cm/s)	Friction Loss (m/100 m)	Friction Loss (bar/100 m)	Velocity (cm/s)	Friction Loss (m/100 m)	Friction Loss (bar/100 m)	Velocity (cm/s)	Friction Loss (m/100 m)	Friction Loss (bar/100 m)	Velocity (cm/s)	Friction Loss (m/100 m)	Friction Loss (bar/100 m)
10	3.2	0.1	0.1																					
15	4.8	0.1	0.1	2.9	0.0	0.0																		
30	9.5	0.4	0.4	5.8	0.1	0.1	4.0	0.1	0.1	2.6	0.0	0.0												
50	15.9	1.1	1.1	9.6	0.3	0.3	6.7	0.1	0.1	4.4	0.0	0.0	3.3	0.0	0.0									
75	23.8	2.4	2.4	14.4	0.7	0.7	10.1	0.3	0.3	6.6	0.1	0.1	4.9	0.1	0.1	3.8	0.0	0.0						
100	31.7	4.1	4.1	19.2	1.2	1.2	13.5	0.5	0.5	8.7	0.2	0.2	6.5	0.1	0.1	5.1	0.0	0.0	3.2	0.0	0.0			
125	39.6	6.3	6.1	24.1	1.9	1.8	16.9	0.8	0.8	10.9	0.3	0.3	8.2	0.1	0.1	6.3	0.1	0.1	4.0	0.0	0.0	2.8	0.0	0.0
150	47.6	8.8	8.6	28.9	2.6	2.6	20.2	1.1	1.1	13.1	0.4	0.4	9.8	0.2	0.2	7.6	0.1	0.1	4.8	0.0	0.0	3.4	0.0	0.0
175	55.5	11.7	11.5	33.7	3.5	3.4	23.6	1.5	1.4	15.3	0.5	0.5	11.4	0.3	0.3	8.9	0.1	0.1	5.6	0.0	0.0	3.9	0.0	0.0
200	63.4	15.0	14.7	38.5	4.4	4.4	27.0	1.9	1.8	17.5	0.7	0.6	13.1	0.3	0.3	10.1	0.2	0.2	6.5	0.1	0.1	4.5	0.0	0.0
225	71.4	18.6	18.2	43.3	5.5	5.4	30.4	2.3	2.3	19.7	0.8	0.8	14.7	0.4	0.4	11.4	0.2	0.2	7.3	0.1	0.1	5.0	0.0	0.0
250	79.3	22.6	22.2	48.1	6.7	6.6	33.7	2.8	2.8	21.9	1.0	1.0	16.3	0.5	0.5	12.7	0.3	0.3	8.1	0.1	0.1	5.6	0.0	0.0
275	87.2	27.0	26.5	52.9	8.0	7.9	37.1	3.4	3.3	24.0	1.2	1.2	18.0	0.6	0.6	13.9	0.3	0.3	8.9	0.1	0.1	6.1	0.0	0.0
300	95.1	31.7	31.1	57.7	9.4	9.2	40.5	4.0	3.9	26.2	1.4	1.4	19.6	0.7	0.7	15.2	0.4	0.4	9.7	0.1	0.1	6.7	0.0	0.0
325	103.1	36.8	36.1	62.6	10.9	10.7	43.9	4.6	4.5	28.4	1.6	1.6	21.2	0.8	0.8	16.5	0.4	0.4	10.5	0.1	0.1	7.3	0.1	0.1
350	111.0	42.2	41.4	67.4	12.5	12.3	47.2	5.3	5.2	30.6	1.8	1.8	22.9	0.9	0.9	17.7	0.5	0.5	11.3	0.2	0.2	7.8	0.1	0.1
400	126.9	54.0	53.0	77.0	16.0	15.7	54.0	6.8	6.6	35.0	2.4	2.3	26.1	1.2	1.1	20.3	0.6	0.6	12.9	0.2	0.2	8.9	0.1	0.1
450	142.7	67.2	65.9	86.6	19.9	19.5	60.7	8.4	8.2	39.3	2.9	2.9	29.4	1.4	1.4	22.8	0.8	0.8	14.5	0.3	0.3	10.1	0.1	0.1
500	158.6	81.7	80.1	96.2	24.2	23.8	67.5	10.2	10.0	43.7	3.6	3.5	32.7	1.8	1.7	25.3	0.9	0.9	16.1	0.3	0.3	11.2	0.1	0.1
550	174.4	97.5	95.5	105.9	28.9	28.3	74.2	12.2	11.9	48.1	4.2	4.2	35.9	2.1	2.0	27.9	1.1	1.1	17.8	0.4	0.4	12.3	0.2	0.2
600	190.3	114.5	112.2	115.5	34.0	33.3	81.0	14.3	14.0	52.5	5.0	4.9	39.2	2.5	2.4	30.4	1.3	1.3	19.4	0.4	0.4	13.4	0.2	0.2
750	237.9	173.1	169.7	144.4	51.4	50.3	101.2	21.7	21.2	65.6	7.5	7.4	49.0	3.7	3.6	38.0	2.0	2.0	24.2	0.7	0.7	16.8	0.3	0.3
1000	317.1	294.9	289.0				134.9	36.9	36.2	87.4	12.8	12.6	65.4	6.3	6.2	50.7	3.4	3.3	32.3	1.1	1.1	22.3	0.5	0.5
1250				240.6	132.3	129.7	168.7	55.8	54.7	109.3	19.4	19.0	81.7	9.6	9.4	63.4	5.2	5.0	40.3	1.7	1.7	27.9	0.7	0.7
1500				288.7	185.5	181.8	202.4	78.2	76.6	131.1	27.2	26.6	98.0	13.4	13.1	76.0	7.2	7.1	48.4	2.4	2.4	33.5	1.0	1.0
1750				336.8	246.7	241.8	236.2	104.0	101.9	153.0	36.2	35.5	114.4	17.8	17.5	88.7	9.6	9.4	56.5	3.2	3.1	39.1	1.3	1.3
2000							269.9	133.2	130.5	174.8	46.3	45.4	130.7	22.8	22.4	101.4	12.3	12.1	64.6	4.1	4.0	44.7	1.7	1.6
3000							404.8	282.2	276.6	262.3	98.2	96.2	196.1	48.4	47.4	152.1	26.1	25.5	96.8	8.7	8.5	67.0	3.6	3.5
4000										349.7	167.2	163.9	261.4	82.4	80.7	202.8	44.4	43.5	129.1	14.8	14.5	89.4	6.1	5.9
5000													326.8	124.6	122.1	253.5	67.1	65.8	161.4	22.4	21.9	111.7	9.1	9.0
6000																304.2	94.1	92.2	193.7	31.4	30.8	134.0	12.8	12.6
7000																			226.0	41.8	40.9	156.4	17.1	16.7
8000																			258.2	53.5	52.4	178.7	21.8	21.4
9000																			290.5	66.5	65.2	201.1	27.2	26.6
10000																			322.8	80.8	79.2	223.4	33.0	32.4
12000																						268.1	46.3	45.4
14000																						312.8	61.6	60.4

Table 3-21: Friction loss for Industrial PVC, and Industrial CPVC Schedule 40 in Metric units (8 in - 24 in)

Flow Rate (L/min)	8 in			10 in			12 in			14 in			16 in			18 in			20 in			24 in		
	Velocity (cm/s)	Friction Loss (m/100 m)	Friction Loss (bar/100 m)	Velocity (cm/s)	Friction Loss (m/100 m)	Friction Loss (bar/100 m)	Velocity (cm/s)	Friction Loss (m/100 m)	Friction Loss (bar/100 m)	Velocity (cm/s)	Friction Loss (m/100 m)	Friction Loss (bar/100 m)	Velocity (cm/s)	Friction Loss (m/100 m)	Friction Loss (bar/100 m)	Velocity (cm/s)	Friction Loss (m/100 m)	Friction Loss (bar/100 m)	Velocity (cm/s)	Friction Loss (m/100 m)	Friction Loss (bar/100 m)			
500	6.5	0.0	0.0	254.5	0.0	0.0	303.2	0.0	0.0	333.4	0.0	0.0	381.0	0.0	0.0	428.7	0.0	0.0	477.9	0.0	0.0	574.7		
550	7.1	0.0	0.0	4.1	0.0	0.0	2.9	0.0	0.0	2.9	0.0	0.0	2.7	0.0	0.0	2.9	0.0	0.0	2.9	0.0	0.0	2.8		
600	7.7	0.0	0.0	4.5	0.0	0.0	3.2	0.0	0.0	3.6	0.0	0.0	3.7	0.0	0.0	3.6	0.0	0.0	3.5	0.0	0.0	3.2		
750	9.7	0.1	0.1	4.9	0.0	0.0	3.5	0.0	0.0	4.3	0.0	0.0	4.6	0.0	0.0	4.3	0.0	0.0	4.1	0.0	0.0	3.2		
1000	12.9	0.1	0.1	6.1	0.0	0.0	4.3	0.0	0.0	6.0	0.0	0.0	5.5	0.0	0.0	5.1	0.0	0.0	4.6	0.0	0.0	3.2		
1250	16.1	0.2	0.2	8.2	0.0	0.0	5.8	0.0	0.0	8.4	0.0	0.0	6.4	0.0	0.0	5.8	0.0	0.0	5.1	0.0	0.0	3.2		
1500	19.4	0.3	0.3	10.2	0.1	0.1	7.2	0.0	0.0	10.1	0.0	0.0	7.3	0.0	0.0	6.4	0.0	0.0	5.1	0.0	0.0	2.8		
1750	22.6	0.3	0.3	12.3	0.1	0.1	8.7	0.0	0.0	13.3	0.1	0.1	8.7	0.0	0.0	7.0	0.0	0.0	5.1	0.0	0.0	2.8		
2000	25.8	0.4	0.4	14.3	0.1	0.1	10.1	0.0	0.0	16.4	0.1	0.1	11.0	0.0	0.0	8.7	0.0	0.0	5.1	0.0	0.0	2.8		
3000	38.7	0.9	0.9	24.6	0.3	0.3	17.3	0.1	0.1	24.6	0.1	0.1	14.3	0.1	0.1	11.5	0.0	0.0	7.0	0.0	0.0	2.8		
4000	51.6	1.6	1.6	32.8	0.5	0.5	23.1	0.2	0.2	32.8	0.1	0.1	14.6	0.1	0.1	11.5	0.0	0.0	9.3	0.0	0.0	2.8		
5000	64.5	2.4	2.4	41.0	0.8	0.8	28.9	0.3	0.3	41.0	0.1	0.1	18.3	0.1	0.1	14.4	0.1	0.1	11.6	0.0	0.0	2.8		
6000	77.5	3.4	3.3	49.1	1.1	1.1	34.6	0.5	0.5	49.1	0.3	0.3	21.9	0.2	0.2	17.3	0.1	0.1	13.9	0.1	0.1	2.8		
7000	90.4	4.5	4.4	57.3	1.5	1.5	40.4	0.6	0.6	57.3	0.4	0.4	25.6	0.2	0.2	20.2	0.1	0.1	16.3	0.1	0.1	2.8		
8000	103.3	5.8	5.6	65.5	1.9	1.9	46.2	0.8	0.8	65.5	0.5	0.5	29.2	0.3	0.3	23.1	0.2	0.2	18.6	0.1	0.1	2.8		
9000	116.2	7.2	7.0	73.7	2.4	2.3	51.9	1.0	1.0	73.7	0.6	0.6	32.9	0.3	0.3	26.0	0.2	0.2	20.9	0.1	0.1	2.8		
10000	129.1	8.7	8.5	81.9	2.9	2.8	57.7	1.2	1.2	81.9	0.8	0.8	36.5	0.4	0.4	28.9	0.2	0.2	23.2	0.1	0.1	2.8		
12500	161.4	13.1	12.9	102.4	4.3	4.3	72.1	1.9	1.8	102.4	1.1	1.1	45.7	0.6	0.6	36.1	0.3	0.3	29.0	0.2	0.2	2.8		
15000	193.6	18.4	18.1	122.9	6.1	6.0	86.6	2.6	2.5	122.9	1.6	1.6	54.8	0.9	0.8	43.3	0.5	0.5	34.8	0.3	0.3	2.8		
17500	225.9	24.5	24.0	143.3	8.1	7.9	101.0	3.5	3.4	143.3	2.2	2.1	64.0	1.1	1.1	50.5	0.6	0.6	40.7	0.4	0.4	2.8		
20000	258.2	31.4	30.8	163.8	10.4	10.2	115.4	4.4	4.3	163.8	2.8	2.7	73.1	1.5	1.4	57.7	0.8	0.8	46.5	0.5	0.5	2.8		
22500	290.5	39.1	38.3	184.3	12.9	12.7	129.8	5.5	5.4	184.3	3.5	3.4	82.2	1.8	1.8	65.0	1.0	1.0	52.3	0.6	0.6	2.8		
25000	322.7	47.5	46.5	204.8	15.7	15.4	144.3	6.7	6.6	204.8	4.2	4.1	91.4	2.2	2.2	72.2	1.2	1.2	58.1	0.7	0.7	2.8		
27500				225.2	18.7	18.3	158.7	8.0	7.8	225.2	5.0	4.9	100.5	2.6	2.6	79.4	1.5	1.5	63.9	0.9	0.9	2.8		
30000				245.7	22.0	21.6	173.1	9.4	9.2	245.7	5.8	5.8	109.6	3.1	3.0	86.6	1.7	1.7	69.7	1.0	1.0	2.8		
35000				286.7	29.3	28.7	202.0	12.5	12.2	286.7	7.9	7.7	127.9	4.1	4.0	101.1	2.3	2.3	81.3	1.4	1.3	2.8		
40000				327.6	37.5	36.7	230.8	16.0	15.7	327.6	10.1	9.9	146.2	5.3	5.2	115.5	3.0	2.9	92.9	1.7	1.7	2.8		
45000							257.7	19.9	19.5		12.5	12.3	164.5	6.5	6.4	129.9	3.7	3.6	104.5	2.2	2.1	2.8		
50000							288.5	24.2	23.7		15.2	14.9	182.7	8.0	7.8	144.4	4.5	4.4	116.2	2.6	2.6	2.8		
60000							346.2	33.9	33.2		20.9	20.9	219.3	11.1	10.9	173.2	6.3	6.2	139.4	3.7	3.6	2.8		
70000										334.1	28.4	27.8	255.8	14.8	14.5	202.1	8.4	8.2	162.6	4.9	4.8	2.8		
80000												292.4	19.0	18.6	231.0	10.7	10.5	185.9	6.3	6.2	2.8			
90000												328.9	23.6	23.2	259.9	13.3	13.0	209.1	7.8	7.7	2.8			
100000												288.7	16.2	15.9	232.3	9.5	9.3	160.6	3.9	3.8	2.8			
120000												346.5	22.7	22.2	278.8	13.4	13.1	192.8	5.4	5.3	2.8			
140000															325.2	17.8	17.4	224.9	7.2	7.1	2.8			
160000																		257.0	9.3	9.1	2.8			
200000																			321.3	14.0	13.7	2.8		

Table 3-22: Friction loss for Industrial PVC, and Industrial CPVC Schedule 80 in Imperial units (1/8 in - 1 1/4 in)

per minute Gallons	1/8 in		1/4 in		3/8 in		1/2 in		3/4 in		1 in		1 1/4 in	
	0.215	0.302	0.423	0.546	0.742	0.957	1.278	1.611	1.944	2.277	2.610	2.943	3.276	3.609
0.25	2.18	13.35	5.79	1.11	2.56	1.11	0.06	0.18	0.03	0.01	0.11	0.01	0.00	0.06
0.5	4.36	48.20	20.90	2.21	9.23	4.00	0.22	0.37	0.12	0.05	0.22	0.03	0.01	0.12
0.75	6.54	102.14	44.28	3.32	19.55	8.48	0.48	0.55	0.25	0.11	0.33	0.07	0.03	0.19
1	8.73	174.01	75.43	4.42	33.31	14.44	0.81	0.73	0.42	0.18	0.44	0.12	0.05	0.25
1.25	10.91	263.06	114.04	5.53	50.36	21.83	1.22	0.92	0.63	0.28	0.55	0.18	0.08	0.31
1.5				6.63	70.58	30.60	1.72	1.10	0.89	0.39	0.66	0.26	0.11	0.37
2				8.85	120.25	52.13	2.92	1.47	1.52	0.66	0.88	0.44	0.19	0.49
2.5				11.06	181.79	78.80	4.42	1.83	2.29	0.99	1.10	0.66	0.29	0.62
3							6.19	2.20	3.21	1.39	1.32	0.93	0.40	0.74
3.5							8.24	2.56	4.27	1.85	1.54	1.24	0.54	0.86
4							10.55	2.93	5.47	2.37	1.76	1.59	0.69	0.99
4.5							13.12	3.30	6.81	2.95	1.98	1.97	0.86	1.11
5							15.95	3.66	8.27	3.59	2.20	2.40	1.04	1.23
7.5							33.79	5.49	17.53	7.60	3.30	5.08	2.20	1.85
10								7.33	29.86	12.94	4.40	8.66	3.75	2.47
12.5								9.16	45.14	19.57	5.51	13.09	5.67	3.09
15								10.99	63.27	27.43	6.61	18.35	7.95	3.70
17.5											7.71	24.41	10.58	4.32
20											8.81	31.26	13.55	4.94
25											11.01	47.25	20.48	6.17
30														7.41
35														8.64
40														9.88
45														11.11
														14.89

Table 3-22: Friction loss for Industrial PVC, and Industrial CPVC Schedule 80 in Imperial units (1 1/2 in - 6 in)

Gallons per minute	1 1/2 in			2 in			2 1/2 in			3 in			3 1/2 in			4 in			5 in			6 in		
	Velocity (ft/s)	Friction Loss (ft/100 ft)	Friction Loss (psi/100 ft)	Velocity (ft/s)	Friction Loss (ft/100 ft)	Friction Loss (psi/100 ft)	Velocity (ft/s)	Friction Loss (ft/100 ft)	Friction Loss (psi/100 ft)	Velocity (ft/s)	Friction Loss (ft/100 ft)	Friction Loss (psi/100 ft)	Velocity (ft/s)	Friction Loss (ft/100 ft)	Friction Loss (psi/100 ft)	Velocity (ft/s)	Friction Loss (ft/100 ft)	Friction Loss (psi/100 ft)	Velocity (ft/s)	Friction Loss (ft/100 ft)	Friction Loss (psi/100 ft)	Velocity (ft/s)	Friction Loss (ft/100 ft)	Friction Loss (psi/100 ft)
2	0.36	0.05	0.02	1.500	1.939	2.323	2.900	3.364	3.826	4.813	5.761													
5	0.90	0.27	0.12	0.54	0.08	0.03	0.34	0.02	0.01	0.24	0.01	0.00												
7	1.25	0.50	0.22	0.75	0.14	0.06	0.52	0.06	0.03	0.34	0.02	0.01	0.25	0.01	0.00									
10	1.79	0.97	0.42	1.07	0.28	0.12	0.75	0.12	0.05	0.48	0.04	0.02	0.36	0.02	0.01	0.28	0.01	4.34						
15	2.69	2.06	0.89	1.61	0.59	0.26	1.12	0.25	0.11	0.72	0.08	0.04	0.53	0.04	0.02	0.41	0.02	6.50	0.26	0.01	0.00			
20	3.59	3.51	1.52	2.15	1.01	0.44	1.49	0.42	0.18	0.96	0.14	0.06	0.71	0.07	0.03	0.55	0.04	8.67	0.35	0.01	0.01	0.24	0.01	0.00
25	4.48	5.31	2.30	2.68	1.52	0.66	1.87	0.63	0.27	1.20	0.21	0.09	0.89	0.10	0.05	0.69	0.06	10.84	0.44	0.02	0.01	0.30	0.01	0.00
30	5.38	7.44	3.22	3.22	2.13	0.92	2.24	0.89	0.38	1.44	0.30	0.13	1.07	0.15	0.06	0.83	0.08	13.01	0.52	0.03	0.01	0.36	0.01	0.00
35	6.27	9.89	4.29	3.75	2.84	1.23	2.62	1.18	0.51	1.68	0.40	0.17	1.25	0.19	0.08	0.96	0.10	15.17	0.61	0.03	0.01	0.43	0.01	0.01
40	7.17	12.67	5.49	4.29	3.63	1.58	2.99	1.51	0.65	1.92	0.51	0.22	1.43	0.25	0.11	1.10	0.13	17.34	0.70	0.04	0.02	0.49	0.02	0.01
45	8.07	15.76	6.83	4.83	4.52	1.96	3.36	1.88	0.81	2.16	0.64	0.28	1.60	0.31	0.13	1.24	0.17	19.51	0.78	0.05	0.02	0.55	0.02	0.01
50	8.96	19.15	8.30	5.36	5.49	2.38	3.74	2.28	0.99	2.40	0.77	0.34	1.78	0.38	0.16	1.38	0.20	21.68	0.87	0.07	0.03	0.61	0.03	0.01
55	9.86	22.85	9.91	5.90	6.55	2.84	4.11	2.72	1.18	2.64	0.92	0.40	1.96	0.45	0.19	1.52	0.24	23.84	0.96	0.08	0.03	0.67	0.03	0.01
60	10.76	26.85	11.64	6.44	7.70	3.34	4.48	3.20	1.39	2.88	1.09	0.47	2.14	0.53	0.23	1.65	0.28	26.01	1.04	0.09	0.04	0.73	0.04	0.02
65	11.65	31.14	13.50	6.97	8.93	3.87	4.86	3.71	1.61	3.12	1.26	0.55	2.32	0.61	0.27	1.79	0.33	28.18	1.13	0.11	0.05	0.79	0.04	0.02
70				7.51	10.24	4.44	5.23	4.25	1.84	3.36	1.45	0.63	2.50	0.70	0.30	1.93	0.38	30.35	1.22	0.12	0.05	0.85	0.05	0.02
75				8.05	11.64	5.05	5.61	4.83	2.09	3.60	1.64	0.71	2.67	0.80	0.35	2.07	0.43	32.51	1.31	0.14	0.06	0.91	0.06	0.03
80				8.58	13.12	5.69	5.98	5.45	2.36	3.84	1.85	0.80	2.85	0.90	0.39	2.20	0.48	34.68	1.39	0.16	0.07	0.97	0.07	0.03
90				9.66	16.32	7.07	6.73	6.77	2.94	4.32	2.30	1.00	3.21	1.12	0.48	2.48	0.60	39.02	1.57	0.20	0.08	1.09	0.08	0.04
100				10.73	19.83	8.60	7.47	8.23	3.57	4.80	2.80	1.21	3.56	1.36	0.59	2.76	0.73	43.35	1.74	0.24	0.10	1.22	0.10	0.04
125							9.34	12.45	5.40	6.00	4.23	1.83	4.46	2.05	0.89	3.44	1.10	54.19	2.18	0.36	0.16	1.52	0.15	0.06
150							11.21	17.44	7.56	7.19	5.93	2.57	5.35	2.88	1.25	4.13	1.54	65.03	2.61	0.50	0.22	1.82	0.21	0.09
175							8.39	7.89	3.42	8.39	7.89	3.42	6.24	3.83	1.66	4.82	2.05	75.86	3.05	0.67	0.29	2.13	0.28	0.12
200							9.59	10.10	4.38	9.59	10.10	4.38	7.13	4.91	2.13	5.51	2.62	86.70	3.48	0.86	0.37	2.43	0.36	0.16
250							11.99	15.27	6.62	11.99	15.27	6.62	8.91	7.42	3.21	6.89	3.96	108.38	4.35	1.30	0.56	3.04	0.54	0.23
300													10.69	10.39	4.51	8.27	5.56	130.05	5.22	1.82	0.79	3.65	0.76	0.33
350													9.64	7.39	4.51	9.64	7.39	151.73	6.09	2.42	1.05	4.25	1.01	0.44
400													11.02	9.47	4.51	11.02	9.47	173.40	6.97	3.10	1.34	4.86	1.29	0.56
450													7.84	3.85	1.67	7.84	3.85	1.67	7.84	3.85	1.67	5.47	1.61	0.70
500													8.71	4.69	2.03	8.71	4.69	2.03	8.71	4.69	2.03	6.08	1.95	0.85
600													10.45	6.57	2.85	10.45	6.57	2.85	10.45	6.57	2.85	7.29	2.74	1.19
700																						8.51	3.64	1.58
800																						9.72	4.67	2.02
900																						10.94	5.80	2.52



Table 3-22: Friction loss for Industrial PVC, and Industrial CPVC Schedule 80 in Imperial units (8 in - 24 in)

Flow Rate (GPM)	8 in			10 in			12 in			14 in			16 in			18 in			20 in			24 in								
	Velocity (ft/s)	Friction Loss (ft/100 ft)	Friction Loss (psi/100 ft)	Velocity (ft/s)	Friction Loss (ft/100 ft)	Friction Loss (psi/100 ft)	Velocity (ft/s)	Friction Loss (ft/100 ft)	Friction Loss (psi/100 ft)	Velocity (ft/s)	Friction Loss (ft/100 ft)	Friction Loss (psi/100 ft)	Velocity (ft/s)	Friction Loss (ft/100 ft)	Friction Loss (psi/100 ft)	Velocity (ft/s)	Friction Loss (ft/100 ft)	Friction Loss (psi/100 ft)	Velocity (ft/s)	Friction Loss (ft/100 ft)	Friction Loss (psi/100 ft)									
75	7.625	0.52	0.01	9.564	0.33	0.00	11.376	0.23	0.00	0.00	12.500	0.23	0.00	0.00	14.314	0.25	0.00	0.00	16.126	0.23	0.00	0.00	17.938	0.22	0.00	0.00	21.564	0.22	0.00	0.00
80		0.56	0.02		0.35	0.01		0.25	0.00	0.00		0.23	0.00	0.00		0.30	0.00	0.00		0.27	0.00	0.00		0.25	0.00	0.00		0.25	0.00	0.00
90		0.62	0.02		0.40	0.01		0.28	0.00	0.00		0.26	0.00	0.00		0.34	0.00	0.00		0.31	0.00	0.00		0.31	0.00	0.00		0.31	0.00	0.00
100		0.69	0.03		0.44	0.01		0.31	0.00	0.00		0.32	0.00	0.00		0.39	0.00	0.00		0.39	0.00	0.00		0.39	0.00	0.00		0.39	0.00	0.00
125		0.87	0.04		0.55	0.01		0.39	0.01	0.00		0.39	0.01	0.00		0.49	0.01	0.00		0.47	0.01	0.00		0.47	0.01	0.00		0.47	0.01	0.00
150		1.04	0.05		0.66	0.02		0.47	0.01	0.00		0.45	0.01	0.00		0.59	0.01	0.00		0.54	0.01	0.00		0.54	0.01	0.00		0.54	0.01	0.00
175		1.21	0.07		0.77	0.02		0.55	0.01	0.00		0.52	0.01	0.00		0.69	0.01	0.00		0.62	0.01	0.00		0.62	0.01	0.00		0.62	0.01	0.00
200		1.39	0.09		0.88	0.03		0.62	0.01	0.01		0.65	0.01	0.00		0.79	0.02	0.01		0.70	0.01	0.00		0.70	0.01	0.00		0.70	0.01	0.00
250		1.73	0.14		1.10	0.05		0.78	0.02	0.01		0.77	0.02	0.01		0.98	0.02	0.01		0.78	0.01	0.01		0.78	0.01	0.01		0.78	0.01	0.01
300		2.08	0.19		1.32	0.06		0.94	0.03	0.01		0.90	0.02	0.01		1.16	0.04	0.02		0.89	0.02	0.01		0.89	0.02	0.01		0.89	0.02	0.01
350		2.43	0.26		1.54	0.09		1.09	0.04	0.02		1.03	0.03	0.01		1.29	0.05	0.02		0.98	0.02	0.01		0.98	0.02	0.01		0.98	0.02	0.01
400		2.78	0.33		1.76	0.11		1.25	0.05	0.02		1.16	0.04	0.02		1.48	0.05	0.02		1.16	0.03	0.01		1.16	0.03	0.01		1.16	0.03	0.01
450		3.12	0.41		1.98	0.14		1.40	0.06	0.03		1.29	0.05	0.02		1.77	0.08	0.04		1.16	0.03	0.01		1.16	0.03	0.01		1.16	0.03	0.01
500		3.47	0.50		2.20	0.17		1.56	0.07	0.03		1.29	0.05	0.02		1.94	0.10	0.04		1.16	0.03	0.01		1.16	0.03	0.01		1.16	0.03	0.01
750		5.20	1.06		3.31	0.35		2.34	0.15	0.07		1.94	0.10	0.04		2.58	0.16	0.07		1.94	0.10	0.04		1.94	0.10	0.04		1.94	0.10	0.04
1000		6.94	1.80		4.41	0.60		3.12	0.26	0.11		2.58	0.16	0.07		3.12	0.26	0.11		2.58	0.16	0.07		2.58	0.16	0.07		2.58	0.16	0.07
1250		8.67	2.73		5.51	0.91		3.90	0.39	0.17		3.23	0.25	0.11		4.68	0.55	0.24		3.23	0.25	0.11		3.23	0.25	0.11		3.23	0.25	0.11
1500		10.41	3.82		6.61	1.27		4.68	0.55	0.24		3.87	0.34	0.15		5.16	0.59	0.25		3.87	0.34	0.15		3.87	0.34	0.15		3.87	0.34	0.15
2000					8.82	2.16		6.23	0.93	0.40		5.16	0.59	0.25		7.79	1.40	0.61		5.16	0.59	0.25		5.16	0.59	0.25		5.16	0.59	0.25
2500					11.02	3.27		7.79	1.40	0.61		6.45	0.89	0.39		8.86	1.36	0.59		6.45	0.89	0.39		6.45	0.89	0.39		6.45	0.89	0.39
3000								9.35	1.97	0.85		7.74	1.24	0.54		9.84	1.66	0.72		7.74	1.24	0.54		7.74	1.24	0.54		7.74	1.24	0.54
3500								10.91	2.62	1.14		9.04	1.66	0.72		10.83	1.98	0.86		9.04	1.66	0.72		9.04	1.66	0.72		9.04	1.66	0.72
4000												10.33	2.12	0.92						10.33	2.12	0.92		10.33	2.12	0.92		10.33	2.12	0.92
4500																														
5000																														
5500																														
6000																														
6500																														
7000																														
7500																														
8000																														
10000																														
11000																														
12000																														



Table 3-23: Friction loss for Industrial PVC, and Industrial CPVC Schedule 80 in Metric units (1/8 in - 1 1/4 in)

Flow Rate (L/min)	1/8 in			1/4 in			3/8 in			1/2 in			3/4 in			1 in			1 1/4 in			
	Velocity (cm/s)	Friction Loss (m/100 m)	Friction Loss (bar/100 m)	Velocity (cm/s)	Friction Loss (m/100 m)	Friction Loss (bar/100 m)	Velocity (cm/s)	Friction Loss (m/100 m)	Friction Loss (bar/100 m)	Velocity (cm/s)	Friction Loss (m/100 m)	Friction Loss (bar/100 m)	Velocity (cm/s)	Friction Loss (m/100 m)	Friction Loss (bar/100 m)	Velocity (cm/s)	Friction Loss (m/100 m)	Friction Loss (bar/100 m)	Velocity (cm/s)	Friction Loss (m/100 m)	Friction Loss (bar/100 m)	
1	17.8	14.7	14.4	7.7	2.8	0.2	13.9	0.2	0.0	0.0	0.0	18.8	1.5	0.0	0.0	24.3	0.9	0.0	32.5	0.5	0.0	0.0
5	88.9	290.3	284.5	45.1	13.8	3.1	27.6	11.2	0.7	0.7	0.7	75	7.5	0.7	0.7	4.5	0.2	0.2	2.5	0.0	0.0	0.0
10	177.9	1048.1	1027.1	90.2	27.6	11.0	55.2	23.8	2.5	2.5	2.5	14.9	14.9	2.5	2.5	9.0	0.7	0.7	5.0	0.2	0.2	0.2
15	266.8	2220.8	2176.4	135.2	41.4	23.4	82.8	40.6	5.4	5.3	5.3	22.4	22.4	5.4	5.3	13.5	1.6	1.5	7.6	0.4	0.4	0.4
20	355.8	3783.5	3707.8	180.3	55.2	39.8	110.3	86.0	9.1	8.9	8.9	29.9	29.9	9.1	8.9	18.0	2.6	2.6	10.1	0.6	0.6	0.6
30				270.5	82.8	84.3	137.9	143.6	19.3	19.0	19.0	44.8	44.8	19.3	19.0	26.9	5.6	5.5	15.1	1.4	1.3	1.3
40				360.7	110.3	143.6	137.9	221.6	33.0	32.3	32.3	59.7	59.7	33.0	32.3	35.9	9.6	9.4	20.1	2.3	2.3	2.3
50					137.9	217.2	206.9	469.5	49.8	48.8	48.8	74.7	74.7	49.8	48.8	44.9	14.4	14.2	25.2	3.5	3.5	3.5
75					206.9	460.1	275.8	799.9	103.5	103.5	103.5	112.0	112.0	103.5	103.5	67.3	30.6	30.0	37.8	7.5	7.5	7.3
100					275.8	783.9	344.8	1209.3	176.3	176.3	176.3	149.4	149.4	176.3	176.3	89.8	52.1	51.1	50.3	12.8	12.8	12.5
125					344.8	1185.1			266.5	266.5	266.5	186.7	186.7	271.9	266.5	112.2	78.8	77.3	62.9	19.3	18.9	18.9
150									373.5	373.5	373.5	224.0	224.0	381.1	373.5	134.7	110.5	108.3	75.5	27.0	26.5	26.5
175									496.9	496.9	496.9	261.4	261.4	507.0	496.9	157.1	147.0	144.1	88.1	36.0	35.3	35.3
200									636.3	636.3	636.3	298.7	298.7	649.3	636.3	179.6	188.3	184.5	100.7	46.1	45.2	45.2
225									791.4	791.4	791.4	336.1	336.1	807.5	791.4	202.0	234.1	229.5	113.3	57.3	56.2	56.2
250																224.5	284.6	278.9	125.9	69.7	68.3	68.3
275																246.9	339.5	332.7	138.5	83.1	81.5	81.5
300																269.4	398.9	390.9	151.0	97.6	95.7	95.7
325																291.8	462.6	453.4	163.6	113.3	111.0	111.0
350																314.3	530.7	520.1	176.2	129.9	127.3	127.3
400																			201.4	166.4	163.0	163.0
500																			251.7	251.5	246.5	246.5
600																			302.1	352.5	345.5	345.5



Table 3-23: Friction loss for Industrial PVC, and Industrial CPVC Schedule 80 in Metric units (8 in - 24 in)

Flow Rate (L/min)	8 in			10 in			12 in			14 in			16 in			18 in			20 in			24 in		
	Velocity (cm/s)	Friction Loss (m/100 m)	Friction Loss (bar/100 m)	Velocity (cm/s)	Friction Loss (m/100 m)	Friction Loss (bar/100 m)	Velocity (cm/s)	Friction Loss (m/100 m)	Friction Loss (bar/100 m)	Velocity (cm/s)	Friction Loss (m/100 m)	Friction Loss (bar/100 m)	Velocity (cm/s)	Friction Loss (m/100 m)	Friction Loss (bar/100 m)	Velocity (cm/s)	Friction Loss (m/100 m)	Friction Loss (bar/100 m)	Velocity (cm/s)	Friction Loss (m/100 m)	Friction Loss (bar/100 m)			
350	5.0	0.0	0.0	3.1	0.0	0.0	2.5	0.0	0.0	2.6	0.0	0.0	2.4	0.0	0.0	2.6	0.0	0.0	2.6	0.0	0.0			
400	5.7	0.0	0.0	3.6	0.0	0.0	2.9	0.0	0.0	2.9	0.0	0.0	3.0	0.0	0.0	3.2	0.0	0.0	3.2	0.0	0.0			
450	6.4	0.0	0.0	4.0	0.0	0.0	3.2	0.0	0.0	3.2	0.0	0.0	3.3	0.0	0.0	3.5	0.0	0.0	3.5	0.0	0.0			
500	7.1	0.0	0.0	4.5	0.0	0.0	3.5	0.0	0.0	3.5	0.0	0.0	3.9	0.0	0.0	4.0	0.0	0.0	4.0	0.0	0.0			
550	7.8	0.1	0.0	4.9	0.0	0.0	3.8	0.0	0.0	3.8	0.0	0.0	4.8	0.0	0.0	5.0	0.0	0.0	5.0	0.0	0.0			
600	8.5	0.1	0.1	5.4	0.0	0.0	4.8	0.0	0.0	4.8	0.0	0.0	6.4	0.0	0.0	6.6	0.0	0.0	6.6	0.0	0.0			
750	10.6	0.1	0.1	6.7	0.0	0.0	6.4	0.0	0.0	6.4	0.0	0.0	7.9	0.0	0.0	7.9	0.0	0.0	7.9	0.0	0.0			
1000	14.1	0.2	0.1	9.0	0.1	0.0	9.5	0.0	0.0	9.5	0.0	0.0	11.1	0.1	0.1	11.1	0.1	0.1	11.1	0.1	0.1			
1250	17.7	0.2	0.2	11.2	0.1	0.1	12.7	0.1	0.1	12.7	0.1	0.1	15.8	0.1	0.1	15.8	0.1	0.1	15.8	0.1	0.1			
1500	21.2	0.3	0.3	13.5	0.1	0.1	19.1	0.2	0.2	19.1	0.2	0.2	21.1	0.2	0.2	21.1	0.2	0.2	21.1	0.2	0.2			
1750	24.8	0.4	0.4	15.7	0.1	0.1	25.4	0.3	0.3	25.4	0.3	0.3	26.3	0.3	0.3	26.3	0.3	0.3	26.3	0.3	0.3			
2000	28.3	0.6	0.5	18.0	0.2	0.2	31.8	0.4	0.4	31.8	0.4	0.4	31.6	0.4	0.4	31.6	0.4	0.4	31.6	0.4	0.4			
3000	42.4	1.2	1.1	27.0	0.4	0.4	44.5	0.8	0.8	44.5	0.8	0.8	42.1	0.6	0.6	42.1	0.6	0.6	42.1	0.6	0.6			
4000	56.6	2.0	2.0	36.0	0.7	0.6	57.2	1.3	1.3	57.2	1.3	1.3	47.4	0.8	0.8	47.4	0.8	0.8	47.4	0.8	0.8			
5000	70.7	3.0	2.9	45.0	1.0	1.0	72.6	2.1	2.1	72.6	2.1	2.1	52.6	1.0	1.0	52.6	1.0	1.0	52.6	1.0	1.0			
6000	84.9	4.2	4.1	53.9	1.4	1.4	92.1	2.8	2.8	92.1	2.8	2.8	63.5	1.6	1.5	63.5	1.6	1.5	63.5	1.6	1.5			
7000	99.0	5.6	5.5	62.9	1.9	1.8	112.4	3.5	3.5	112.4	3.5	3.5	79.4	2.3	2.3	79.4	2.3	2.3	79.4	2.3	2.3			
8000	113.1	7.2	7.0	71.9	2.4	2.3	134.9	4.4	4.4	134.9	4.4	4.4	95.3	3.3	3.2	95.3	3.3	3.2	95.3	3.3	3.2			
9000	127.3	8.9	8.8	80.9	3.0	2.9	158.9	5.5	5.5	158.9	5.5	5.5	105.3	4.4	4.3	105.3	4.4	4.3	105.3	4.4	4.3			
10000	141.4	10.9	10.6	89.9	3.6	3.5	184.2	6.8	6.8	184.2	6.8	6.8	118.4	5.2	5.2	118.4	5.2	5.2	118.4	5.2	5.2			
12500	176.8	16.4	16.1	112.4	5.5	5.3	224.4	10.1	9.9	224.4	10.1	9.9	144.7	6.4	6.3	144.7	6.4	6.3	144.7	6.4	6.3			
15000	212.2	23.0	22.6	134.9	7.6	7.5	285.9	15.5	15.5	285.9	15.5	15.5	184.2	8.3	8.3	184.2	8.3	8.3	184.2	8.3	8.3			
17500	247.5	30.6	30.0	157.3	10.2	10.0	317.7	21.6	21.6	317.7	21.6	21.6	210.5	10.8	10.8	210.5	10.8	10.8	210.5	10.8	10.8			
20000	282.9	39.2	38.4	179.8	13.0	12.8	371.7	28.5	28.5	371.7	28.5	28.5	236.8	13.9	13.9	236.8	13.9	13.9	236.8	13.9	13.9			
22500	318.2	48.8	47.8	202.3	16.2	15.9	409.6	36.0	36.0	409.6	36.0	36.0	263.1	17.3	17.3	263.1	17.3	17.3	263.1	17.3	17.3			
25000	353.5	59.4	58.4	224.8	19.7	19.3	459.6	44.4	44.4	459.6	44.4	44.4	291.6	21.1	21.1	291.6	21.1	21.1	291.6	21.1	21.1			
27500	388.8	70.9	70.0	247.2	23.5	23.0	519.6	52.8	52.8	519.6	52.8	52.8	315.8	25.1	25.1	315.8	25.1	25.1	315.8	25.1	25.1			
30000	424.1	82.4	81.4	269.7	27.6	27.0	579.6	61.2	61.2	579.6	61.2	61.2	340.0	29.1	29.1	340.0	29.1	29.1	340.0	29.1	29.1			
35000	500.0	102.9	102.0	314.7	36.7	36.0	679.6	79.6	79.6	679.6	79.6	79.6	391.6	36.0	36.0	391.6	36.0	36.0	391.6	36.0	36.0			
40000	575.6	123.4	122.4	359.6	45.1	44.4	779.6	98.0	98.0	779.6	98.0	98.0	433.2	44.4	44.4	433.2	44.4	44.4	433.2	44.4	44.4			
45000	651.1	143.9	142.9	404.6	53.5	52.8	879.6	116.4	116.4	879.6	116.4	116.4	474.8	52.8	52.8	474.8	52.8	52.8	474.8	52.8	52.8			
50000	726.7	164.4	163.4	449.6	61.9	61.2	979.6	134.8	134.8	979.6	134.8	134.8	516.4	61.2	61.2	516.4	61.2	61.2	516.4	61.2	61.2			
60000	852.2	205.9	204.9	544.6	79.6	78.9	1179.6	173.2	173.2	1179.6	173.2	173.2	591.6	78.9	78.9	591.6	78.9	78.9	591.6	78.9	78.9			
70000	977.7	247.4	246.4	639.6	97.0	96.3	1379.6	211.6	211.6	1379.6	211.6	211.6	666.4	96.3	96.3	666.4	96.3	96.3	666.4	96.3	96.3			
80000	1103.2	288.9	287.9	734.6	115.4	114.7	1579.6	250.0	250.0	1579.6	250.0	250.0	741.2	114.7	114.7	741.2	114.7	114.7	741.2	114.7	114.7			
90000	1228.7	330.4	329.4	829.6	133.8	133.1	1779.6	288.4	288.4	1779.6	288.4	288.4	816.0	133.1	133.1	816.0	133.1	133.1	816.0	133.1	133.1			
100000	1354.2	371.9	370.9	924.6	152.2	151.5	1979.6	326.8	326.8	1979.6	326.8	326.8	890.8	151.5	151.5	890.8	151.5	151.5	890.8	151.5	151.5			
110000	1479.7	413.4	412.4	1019.6	170.6	169.9	2179.6	365.2	365.2	2179.6	365.2	365.2	965.6	169.9	169.9	965.6	169.9	169.9	965.6	169.9	169.9			
125000	1655.2	494.9	493.9	1164.6	211.0	210.3	2519.6	443.6	443.6	2519.6	443.6	443.6	1110.4	210.3	210.3	1110.4	210.3	210.3	1110.4	210.3	210.3			
150000	1980.7	616.4	615.4	1409.6	270.4	269.7	2959.6	562.0	562.0	2959.6	562.0	562.0	1304.0	269.7	269.7	1304.0	269.7	269.7	1304.0	269.7	269.7			
175000	2306.2	737.9	736.9	1654.6	329.8	329.1	3399.6	680.4	680.4	3399.6	680.4	680.4	1497.6	329.1	329.1	1497.6	329.1	329.1	1497.6	329.1	329.1			

Table 3-24: Friction loss for Industrial PVC Schedule 120 in Imperial units (1/2 in - 2 1/2 in)

Gallons per minute	1/2 in			3/4 in			1 in			1 1/4 in			1 1/2 in			2 in			2 1/2 in			
	Friction Loss (psi/100 ft)	Friction Loss (ft/100 ft)	Velocity (ft/s)	Friction Loss (psi/100 ft)	Friction Loss (ft/100 ft)	Velocity (ft/s)	Friction Loss (psi/100 ft)	Friction Loss (ft/100 ft)	Velocity (ft/s)	Friction Loss (psi/100 ft)	Friction Loss (ft/100 ft)	Velocity (ft/s)	Friction Loss (psi/100 ft)	Friction Loss (ft/100 ft)	Velocity (ft/s)	Friction Loss (psi/100 ft)	Friction Loss (ft/100 ft)	Velocity (ft/s)	Friction Loss (psi/100 ft)	Friction Loss (ft/100 ft)	Velocity (ft/s)	
0.25	0.40	0.22	0.10	0.20	0.04	0.02	0.12	0.01	0.01	0.07	0.00	0.00	0.05	0.00	0.00	0.03	0.00	0.00	0.00	0.00	0.00	0.02
0.5	0.81	0.79	0.34	0.40	0.14	0.06	0.24	0.04	0.02	0.13	0.01	0.00	0.10	0.00	0.00	0.06	0.00	0.00	0.00	0.00	0.00	0.04
0.75	1.21	1.68	0.73	0.60	0.31	0.13	0.36	0.09	0.04	0.20	0.02	0.01	0.14	0.01	0.00	0.09	0.00	0.00	0.00	0.00	0.00	0.06
1	1.61	2.87	1.24	0.80	0.52	0.23	0.48	0.15	0.07	0.27	0.04	0.02	0.19	0.02	0.01	0.11	0.00	0.00	0.00	0.00	0.00	0.08
2	3.23	10.34	4.48	1.60	1.88	0.81	0.96	0.55	0.24	0.53	0.13	0.06	0.38	0.06	0.03	0.23	0.02	0.01	0.01	0.00	0.00	0.16
5	8.07	56.46	24.47	4.00	10.25	4.44	2.41	2.98	1.29	1.33	0.71	0.31	0.96	0.32	0.14	0.57	0.09	0.04	0.04	0.00	0.00	0.39
7	11.29	105.28	45.64	5.60	19.12	8.29	3.37	5.56	2.41	1.87	1.32	0.57	1.34	0.59	0.26	0.80	0.17	0.07	0.07	0.00	0.00	0.55
10				8.00	37.00	16.04	4.82	10.77	4.67	2.67	2.55	1.11	1.92	1.15	0.50	1.15	0.33	0.14	0.14	0.00	0.00	0.78
15				12.00	78.41	33.99	7.23	22.82	9.89	4.00	5.41	2.35	2.88	2.43	1.05	1.72	0.70	0.30	0.30	0.00	0.00	1.17
20							9.64	38.88	16.86	5.33	9.22	4.00	3.84	4.14	1.79	2.29	1.19	0.51	0.51	0.00	0.00	1.56
25							12.04	58.78	25.48	6.67	13.93	6.04	4.80	6.26	2.71	2.87	1.79	0.78	0.78	0.00	0.00	1.95
30										8.00	19.53	8.47	5.76	8.77	3.80	3.44	2.51	1.09	1.09	0.00	0.00	2.34
35										9.33	25.99	11.26	6.71	11.67	5.06	4.02	3.34	1.45	1.45	0.00	0.00	2.73
40										10.66	33.28	14.43	7.67	14.94	6.48	4.59	4.28	1.85	1.85	0.00	0.00	3.12
45													8.63	18.59	8.06	5.16	5.32	2.31	2.31	0.00	0.00	3.51
50													9.59	22.59	9.79	5.74	6.47	2.80	2.80	0.00	0.00	3.90
55													10.55	26.95	11.68	6.31	7.72	3.35	3.35	0.00	0.00	4.29
60																6.88	9.07	3.93	3.93	0.00	0.00	4.68
65																7.46	10.51	4.56	4.56	0.00	0.00	5.07
70																8.03	12.06	5.23	5.23	0.00	0.00	5.46
75																8.61	13.71	5.94	5.94	0.00	0.00	5.85
80																9.18	15.45	6.70	6.70	0.00	0.00	6.23
90																10.33	19.21	8.33	8.33	0.00	0.00	7.01
100																						7.79
110																						8.57
120																						9.35
130																						10.13



Table 3-24: Friction loss for Industrial PVC Schedule 120 in Imperial units (3 in - 8 in)

Gallons per minute	3 in			4 in			6 in			8 in		
	Velocity (ft/s)	Friction Loss (ft/100 ft)	Friction Loss (psi/100 ft)	Velocity (ft/s)	Friction Loss (ft/100 ft)	Friction Loss (psi/100 ft)	Velocity (ft/s)	Friction Loss (ft/100 ft)	Friction Loss (psi/100 ft)	Velocity (ft/s)	Friction Loss (ft/100 ft)	Friction Loss (psi/100 ft)
10	0.51	0.05	0.02	0.31	0.01	0.01	0.13	0.00	0.00	0.08	0.00	0.00
15	0.77	0.10	0.04	0.46	0.03	0.01	0.20	0.00	0.00	0.12	0.00	0.00
20	1.03	0.17	0.07	0.61	0.05	0.02	0.27	0.01	0.00	0.16	0.00	0.00
25	1.29	0.25	0.11	0.77	0.07	0.03	0.33	0.01	0.00	0.20	0.00	0.00
30	1.54	0.36	0.15	0.92	0.10	0.04	0.40	0.01	0.01	0.23	0.00	0.00
35	1.80	0.47	0.21	1.07	0.13	0.06	0.47	0.02	0.01	0.27	0.00	0.00
40	2.06	0.61	0.26	1.23	0.17	0.07	0.53	0.02	0.01	0.31	0.01	0.00
45	2.32	0.76	0.33	1.38	0.21	0.09	0.60	0.03	0.01	0.35	0.01	0.00
50	2.57	0.92	0.40	1.53	0.26	0.11	0.67	0.03	0.01	0.39	0.01	0.00
55	2.83	1.10	0.48	1.69	0.31	0.14	0.73	0.04	0.02	0.43	0.01	0.00
60	3.09	1.29	0.56	1.84	0.37	0.16	0.80	0.05	0.02	0.47	0.01	0.01
65	3.34	1.49	0.65	1.99	0.42	0.18	0.87	0.06	0.02	0.51	0.02	0.01
70	3.60	1.71	0.74	2.15	0.49	0.21	0.93	0.06	0.03	0.55	0.02	0.01
75	3.86	1.95	0.84	2.30	0.55	0.24	1.00	0.07	0.03	0.59	0.02	0.01
80	4.12	2.19	0.95	2.45	0.62	0.27	1.07	0.08	0.04	0.62	0.02	0.01
90	4.63	2.73	1.18	2.76	0.78	0.34	1.20	0.10	0.04	0.70	0.03	0.01
100	5.14	3.32	1.44	3.07	0.94	0.41	1.33	0.12	0.05	0.78	0.03	0.01
125	6.43	5.02	2.17	3.83	1.43	0.62	1.67	0.19	0.08	0.98	0.05	0.02
150	7.72	7.03	3.05	4.60	2.00	0.87	2.00	0.26	0.11	1.17	0.07	0.03
175	9.00	9.35	4.06	5.37	2.66	1.15	2.33	0.35	0.15	1.37	0.10	0.04
200	10.29	11.98	5.19	6.14	3.41	1.48	2.67	0.45	0.19	1.56	0.12	0.05
250				7.67	5.15	2.23	3.33	0.68	0.29	1.95	0.18	0.08
300				9.20	7.22	3.13	4.00	0.95	0.41	2.34	0.26	0.11
350				10.74	9.60	4.16	4.67	1.26	0.55	2.73	0.34	0.15
400							5.33	1.62	0.70	3.12	0.44	0.19
450							6.00	2.01	0.87	3.51	0.55	0.24
500							6.66	2.45	1.06	3.90	0.67	0.29
750							10.00	5.18	2.25	5.85	1.41	0.61
1000										7.80	2.40	1.04
1250										9.76	3.63	1.57
1500										11.71	5.09	2.21



Table 3-25: Friction loss for Industrial PVC Schedule 120 in Metric units (1 1/2 in - 2 1/2 in)

Flow Rate (L/min)	1/2 in			3/4 in			1 in			1 1/4 in			1 1/2 in			2 in			2 1/2 in					
	Friction Loss (bar/100 m)	Friction Loss (m/100 m)	Velocity (cm/s)	Friction Loss (bar/100 m)	Friction Loss (m/100 m)	Velocity (cm/s)	Friction Loss (bar/100 m)	Friction Loss (m/100 m)	Velocity (cm/s)	Friction Loss (bar/100 m)	Friction Loss (m/100 m)	Velocity (cm/s)	Friction Loss (bar/100 m)	Friction Loss (m/100 m)	Velocity (cm/s)	Friction Loss (bar/100 m)	Friction Loss (m/100 m)	Velocity (cm/s)	Friction Loss (bar/100 m)	Friction Loss (m/100 m)	Velocity (cm/s)			
1	3.3	0.2	0.2	1.6	0.0	0.0	4.9	0.3	0.2	2.7	0.1	0.1	3.9	0.1	0.1	5.9	0.2	0.2	3.5	0.1	0.1	2.4	0.0	0.0
5	16.4	4.8	4.7	8.2	0.9	0.9	9.8	0.9	0.9	5.4	0.2	0.2	5.9	0.2	0.2	11.7	0.7	0.7	7.0	0.2	0.2	4.8	0.1	0.1
10	32.9	17.3	16.9	16.3	3.1	3.1	14.7	1.9	1.9	8.2	0.5	0.4	11.7	0.7	0.7	19.6	1.9	1.9	11.7	0.5	0.5	7.9	0.2	0.2
15	49.3	36.6	35.8	24.5	6.6	6.5	29.5	7.0	6.8	16.3	1.7	1.6	19.6	1.9	1.9	29.3	4.1	4.0	17.5	1.2	1.1	11.9	0.5	0.4
30	98.7	132.0	129.4	48.9	24.0	23.5	49.1	18.0	17.6	27.2	4.3	4.2	39.1	6.9	6.8	48.9	10.4	10.2	29.2	3.0	2.9	19.9	1.2	1.1
50	164.5	340.0	333.2	81.6	61.7	60.5	73.7	38.1	37.3	40.8	9.0	8.8	58.7	14.6	14.3	78.2	24.9	24.4	46.8	7.1	7.0	31.8	2.8	2.7
75	246.7	720.5	706.1	122.3	130.8	128.2	98.2	64.9	63.6	54.4	15.4	15.1	88.0	31.0	30.4	88.0	31.0	30.4	52.6	8.9	8.7	35.7	3.5	3.4
100	328.9	1227.5	1203.0	163.1	222.9	218.4	122.8	98.1	96.1	67.9	23.2	22.8	97.8	37.7	36.9	107.6	45.0	44.1	58.5	10.8	10.6	39.7	4.2	4.1
125				203.9	336.9	330.2	147.3	137.5	134.7	81.5	32.6	31.9	107.6	45.0	44.1	107.6	45.0	44.1	64.3	12.9	12.6	43.7	5.0	4.9
150				244.7	472.3	462.8	171.9	182.9	179.2	95.1	43.4	42.5	117.3	52.8	51.8	117.3	52.8	51.8	70.2	15.1	14.8	47.7	5.9	5.8
175				285.5	628.3	615.7	196.4	234.2	229.5	108.7	55.5	54.4	127.1	61.3	60.0	127.1	61.3	60.0	76.0	17.5	17.2	51.6	6.8	6.7
200				326.3	804.6	788.5	221.0	291.3	285.5	122.3	69.1	67.7	136.9	70.3	68.9	136.9	70.3	68.9	81.9	20.1	19.7	55.6	7.9	7.7
225							245.5	354.0	347.0	135.9	83.9	82.3	156.4	90.0	88.2	156.4	90.0	88.2	93.6	25.8	25.3	63.6	10.1	9.9
250							270.1	422.4	413.9	149.5	100.1	98.1	176.0	111.9	109.7	176.0	111.9	109.7	105.3	32.1	31.4	71.5	12.5	12.3
300							294.7	496.3	486.3	163.1	117.6	115.3	195.6	136.1	133.3	195.6	136.1	133.3	117.0	39.0	38.2	79.4	15.2	14.9
325							319.2	575.5	564.0	176.6	136.4	133.7	215.1	162.3	159.1	215.1	162.3	159.1	128.6	46.5	45.5	87.4	18.1	17.8
350										190.2	156.5	153.4	234.7	190.7	186.9	234.7	190.7	186.9	140.3	54.6	53.5	95.3	21.3	20.9
400										217.4	200.4	196.4	293.3	288.3	282.5	293.3	288.3	282.5	175.4	82.5	80.9	119.2	32.2	31.6
450										244.6	249.3	244.3	391.1	491.2	481.3	391.1	491.2	481.3	233.9	140.6	137.8	158.9	54.9	53.8
500										271.8	303.0	296.9	292.4	212.6	208.3	292.4	212.6	208.3	292.4	212.6	208.3	198.6	83.0	81.3
550										298.9	361.5	354.3	350.9	298.0	292.0	350.9	298.0	292.0	350.9	298.0	292.0	238.3	116.3	114.0
600										326.1	424.7	416.2										278.0	154.7	151.6
750																						317.8	198.1	194.2
1000																						199	83.0	81.3
1250																								
1500																								
1750																								
2000																								
1250																								

Table 3-25: Friction loss for Industrial PVC Schedule 120 in Metric units (3 in - 8 in)

Flow Rate (L/min)	3 in			4 in			6 in			8 in		
	Friction Loss (bar/100 m)	Friction Loss (m/100 m)	Velocity (cm/s)	Friction Loss (bar/100 m)	Friction Loss (m/100 m)	Velocity (cm/s)	Friction Loss (bar/100 m)	Friction Loss (m/100 m)	Velocity (cm/s)	Friction Loss (bar/100 m)	Friction Loss (m/100 m)	Velocity (cm/s)
100	10.5	0.3	0.3	6.3	0.1	0.1	139.7254	182.6006				
125	13.1	0.4	0.4	7.8	0.1	0.1						
150	15.7	0.6	0.6	9.4	0.2	0.2	4.1	0.0				
175	18.4	0.8	0.8	10.9	0.2	0.2	4.8	0.0	0.0			
200	21.0	1.0	1.0	12.5	0.3	0.3	5.4	0.0	0.0			
225	23.6	1.3	1.2	14.1	0.4	0.4	6.1	0.0	0.0			
250	26.2	1.5	1.5	15.6	0.4	0.4	6.8	0.1	0.1	3.6	0.0	0.0
275	28.8	1.8	1.8	17.2	0.5	0.5	7.5	0.1	0.1	4.0	0.0	0.0
300	31.5	2.1	2.1	18.8	0.6	0.6	8.2	0.1	0.1	4.4	0.0	0.0
325	34.1	2.5	2.4	20.3	0.7	0.7	8.8	0.1	0.1	4.8	0.0	0.0
350	36.7	2.9	2.8	21.9	0.8	0.8	9.5	0.1	0.1	5.2	0.0	0.0
400	42.0	3.7	3.6	25.0	1.0	1.0	10.9	0.1	0.1	5.6	0.0	0.0
450	47.2	4.6	4.5	28.1	1.3	1.3	12.2	0.2	0.2	6.4	0.0	0.0
500	52.4	5.5	5.4	31.3	1.6	1.5	13.6	0.2	0.2	7.2	0.0	0.0
550	57.7	6.6	6.5	34.4	1.9	1.8	14.9	0.2	0.2	8.0	0.1	0.1
600	62.9	7.8	7.6	37.5	2.2	2.2	16.3	0.3	0.3	8.8	0.1	0.1
750	78.7	11.7	11.5	46.9	3.3	3.3	20.4	0.4	0.4	9.5	0.1	0.1
1000	104.9	20.0	19.6	62.5	5.7	5.6	27.2	0.7	0.7	11.9	0.1	0.1
1250	131.1	30.2	29.6	78.2	8.6	8.4	34.0	1.1	1.1	15.9	0.2	0.2
1500	157.3	42.3	41.5	93.8	12.0	11.8	40.8	1.6	1.6	19.9	0.3	0.3
1750	183.6	56.3	55.2	109.5	16.0	15.7	47.6	2.1	2.1	23.9	0.4	0.4
2000	209.8	72.1	70.7	125.1	20.5	20.1	54.3	2.7	2.6	27.8	0.6	0.6
3000	314.7	152.9	149.8	187.6	43.5	42.6	81.5	5.7	5.6	31.8	0.7	0.7
4000				250.2	74.0	72.6	108.7	9.7	9.5	47.7	1.6	1.5
5000				312.7	111.9	109.7	135.9	14.7	14.4	63.6	2.7	2.6
6000							163.0	20.6	20.2	79.6	4.0	3.9
7000							190.2	27.5	26.9	95.5	5.6	5.5
8000							217.4	35.2	34.5	111.4	7.5	7.3
9000							244.6	43.8	42.9	127.3	9.6	9.4
10000							271.7	53.2	52.1	143.2	11.9	11.7
12500							339.7	80.4	78.8	159.1	14.5	14.2
15000										198.9	21.9	21.4
17500										238.7	30.6	30.0
20000										278.4	40.8	40.0
12500										318.2	52.2	51.2
										199	21.9	21.4

The nomograph in Figure 3-3 provides approximate values for a wide range of thermoplastic pipe sizes. The nomograph is used by lining up values on the scales by means of a ruler or straight edge. Two independent variables must be set to obtain the other values. For example, line (1) indicates that 500 gpm may be obtained with a 6 in inside diameter pipe with a pressure loss of about 0.65 psi per 100 feet of pipe at a velocity of 6.0 ft/s. Line (2) indicates that to have a flow of

about 60 gpm at with a loss of pressure of 2 psi per 100 feet of pipe, you must have a pipe with an inside diameter of 2.1 in. Line (3) and dotted line (3) show that with a flow of 70 gpm, to reduce the pressure loss from 4 psi to 3 psi per 100 feet of pipe, the pipe size must increase from 2 in to 2.1 in inside diameter. Flow velocities in excess of 5.0 ft/s (1.5 m/s) are not recommended.

**Figure 3-3: Head Loss Nomograph**

Courtesy of Plastics Pipe Institute, a division of The Society of The Plastics Industry

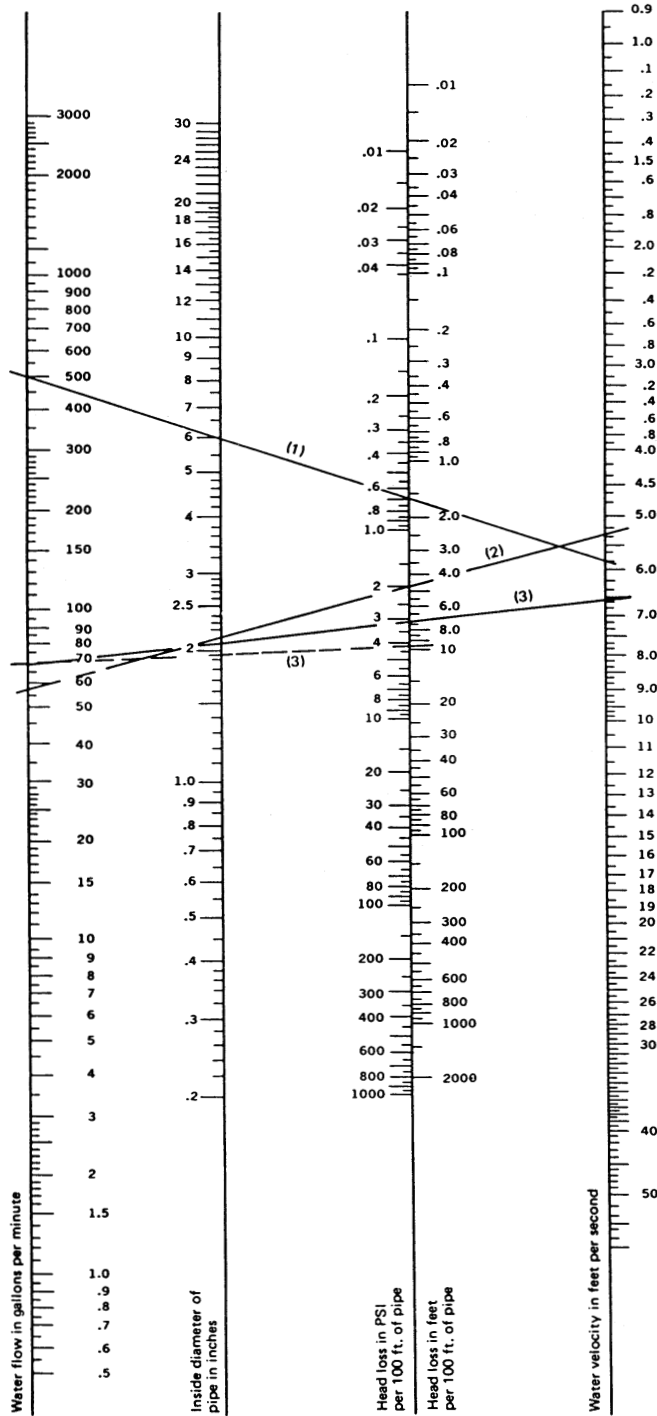

## Pressure Loss of Fittings

Pressure loss due to fittings depends on the type. In general it can be calculated from the following formula:

$$L_e = K_r \times \frac{V^2}{2 \times g}$$

where

$L_e$  = Head loss in equivalent feet of pipe

$K_r$  = resistance coefficient (dimensionless, depends on fitting type)

$g$  = Gravitational constant 32 ft/sec<sup>2</sup>

$V$  = Flow velocity in ft/sec

$K_r$

Sweep 90	Sharp 90	45 Elbow	Tee	Reducer	Increaser
0.4	1.2	0.3	1.3	1.0	0.5

The pressure loss due to all fittings in the piping system is the sum of each  $L_e$ . For example, the pressure loss due to ten sweep 90 elbows in a system flowing at 5 ft/sec is approximately:

$$L_e = (10 \times 0.4) \times \frac{5^2}{2 \times 32} = 1.6 \text{ ft pipe equivalent}$$

## Drainage Design

Drainage systems are to be designed to maintain a minimum velocity of 2 ft/s (0.6 m/s) to prevent build-up of sediment, inhibit bacterial growth, and promote self-cleaning of the system. The velocity of the drainage system can be determined by:

### Equation (3-18) - Imperial

$$V = 1.49n^{-1}R^{2/3}S^{1/2}$$

### Equation (3-19) - Metric

$$V = 1.00n^{-1}R^{2/3}S^{1/2}$$

Conversely Equation (3-21) and Equation (3-22) above can be rearranged to find the required slope of the system via

### Equation (3-20) - Imperial

$$S = 0.45n^2R^{-2/3}V^2$$

### Equation (3-20) - Imperial Example

What is the velocity of water in a half-filled 2" Schedule 80 CPVC pipe with a slope of 0.005?

$$S = 0.005$$

$$r_i = \frac{2.375 \text{ in}}{2} - 0.218 \text{ in} = 0.9695 \text{ in}$$

$$R = \frac{A}{P_w} = \frac{\pi r_i^2}{2} \times \frac{2}{2\pi r_i} = \frac{r_i}{2} = 0.485 \text{ in} = 0.040 \text{ ft}$$

$$V = 1.49 (0.009)^{-1} (0.040 \text{ ft})^{2/3} (0.005)^{1/2}$$

$$V = 1.37 \text{ ft/s}$$

Where:

$V$  = Cross-sectional mean velocity of fully developed flow, ft/s (m/s)

$n$  = Manning's coefficient, unitless

$R$  = Hydraulic radius =  $A/P_w$  ft (m)

$S$  = Slope, ft/ft (m/m)

$A$  = Cross-sectional area of fluid, ft<sup>2</sup> (m<sup>2</sup>)

$P_w$  = Wetted perimeter, ft (m)

### Equation (3-21) - Metric

$$S = 1.00n^2R^{-2/3}V^2$$

### Equation (3-21) - Metric

What is the required slope to maintain a velocity of 0.7 m/s in a 2" Schedule 80 CPVC pipe completely filled?

$$n = 0.009$$

$$V = 0.7 \text{ m/s}$$

$$r_i = \frac{60.33 \text{ mm}}{2} - 5.537 \text{ mm} = 24.6 \text{ mm}$$

$$R = \frac{A}{P_w} = \frac{\pi r_i^2}{2} \times \frac{2}{2\pi r_i} = \frac{r_i}{2} = 12.3 \text{ mm} = 0.0123 \text{ m}$$

$$S = 1.00 (0.009)^2 (0.0123 \text{ m})^{-2/3} (0.7 \text{ m/s})^2$$

$$S = 0.014$$

$$S = \text{drop of 14m for every 1000m}$$

The Manning coefficient used in the above equations are constants, some of which are listed in Table 3-26.

**Table 3-26 Manning's coefficient for various materials**

Material	n
CPVC	0.009
Copper	0.011
Steel	0.012

# Installation Instructions

The following information is considered general in nature and is provided as a reference to assist in ensuring the highest system integrity during installation. Thermoplastic piping systems must be designed, engineered, installed, and operated in accordance with accepted industry standards and practices, as well as any applicable code requirements. Suitability for the intended service must be clearly established prior to use. Proper selection, application, and installation of thermoplastic piping products are the responsibility of the end user.

## Storage and Handling

Piping products from GF Piping Systems are inspected, handled, and loaded with great care at the factory using methods that have been developed specifically for thermoplastic piping products to ensure that damage is minimized and overall quality is maintained during shipping. It is the carrier's responsibility to deliver the shipment in good condition. It is the receiver's responsibility to ensure that there has been no loss or damage and that the products are unloaded and stored properly after receipt. Reasonable care and common sense should be used when handling and storing GF Piping Systems thermoplastic piping products.

Thermoplastic pipe and fittings may be stored indoors or outside in yards. If stored outdoors, pipe and fittings should be protected from direct exposure to sunlight, and pipe should be properly supported in storage to prevent sagging or bending. Pipe should be stored in the yard on level ground in the unit packages provided by the factory. Caution must be exercised to avoid compression, damage, or deformation. When unit packages are stacked, care must be used to ensure that the weight of the upper units does not cause deformation to pipe in the lower units. Package units should not be stacked more than 8 ft (2.5 m) high. Care must be used to ensure that the height of the stack does not result in instability which can cause collapse, pipe damage, or personnel injury. Unit packages should be supported by wooden racks or other suitable means and spaced properly to prevent damage.

Thermoplastic pipe and fittings must not be stored in tightly enclosed areas subject to elevated temperatures or close to heat producing sources such as heaters, boilers, steam lines, engine exhaust, etc. Exposure to excessive temperatures will result in distortion and deformation of the product. When stored outdoors, thermoplastic pipe must be covered with non-transparent material. This covering must provide adequate air circulation above and around the pipe as required to prevent excessive heat absorption that can result in discoloration and deformation of the product. PVC and CPVC piping products in storage should not be exposed to temperatures above 140°F (66°C) and 200°F (99°C), respectively.

Although GF Piping Systems products are tough and corrosion resistant, they should not be dropped, have objects dropped on them, nor be subjected to external loads. Thermoplastics can be damaged by abrasion and gouging. Pipe must not be dragged across the ground or over obstacles. Impacts such as dropping and/or rough handling should be avoided particularly in cold weather. The product shall be inspected for any scratches, splits, or gouges that may have occurred from improper handling or storage. If found, damaged sections must be cut out and discarded.

## Thermoplastic Piping Tools

The use of tools that have been specifically designed for use with thermoplastic pipe and fittings is strongly recommended to obtain optimum results when installing thermoplastic piping systems. A variety of tools that are designed for cutting, beveling, and assembling plastic pipe and fittings are readily available through local wholesale supply houses dealing in plastic pipe and fittings. Improper use of tools normally used with metal piping systems, i.e. hacksaws, water pump pliers, pipe wrenches, etc., can cause damage to plastic pipe and fittings. Visible and non-visible fractures, scoring or gouging of material and over tightening of plastic threaded connections are some of the major problems associated with the use of incorrect tools and/or procedures.

### Pipe Cutters

Plastic pipe must have square-cut ends to allow for the proper interfacing of the pipe end and the fitting socket bottom. A wheel type pipe cutter with special blades for plastic pipe provides easy and clean cutting action. The raised bead left on the outside of the pipe after cutting must then be removed. A miter box saw may also be used to produce square-cut ends.

### Pipe Cutters for Large Diameter Pipe

Blade cutters made for use with large diameter plastic pipe are easy to adjust and operate for square, burr-less cuts. Blades with carbide edges will provide longer life. With one style blade cutter, pipe ends may also be beveled for solvent joints while being cut by using an optional bevel tool in place of one cutter blade.

### Power Saws

Power saws specifically for use with plastic pipe are available. These are particularly useful in prefabrication operations where a large quantity of pipe is being cut. Blades designed for thermoplastic pipe **MUST** be used. Follow manufacturer's instructions regarding speed, set, and proper use of the tool.

### Power Beveling Tools

Portable and mounted power beveling tools as well as hand beveling tools specifically designed for use with plastic pipe are available. Pipe ends must be beveled (chamfered) to allow easy insertion of the pipe into the fitting and to help prevent scraping the solvent cement from the inside of the fitting socket. A recommended bevel of 3/32 in (2.5 mm) at a



10° to 15° angle can be quickly achieved using a plastic pipe beveling tool.

### Deburring Tools

A smooth, beveled pipe end helps spread the solvent easily as the pipe is joined to the fitting. All burrs must be removed from the inside as well as the outside of the pipe ends. Special plastic pipe deburring tools deburr pipe ends quickly and efficiently.

### Strap Wrenches and Chain Vises

Strap wrenches with special woven nylon straps are extra strong and are treated for slip resistance. These strap wrenches, designed for use with plastic pipe, provide gripping power for turning without scratching or deforming the pipe.

Chain vises are made with jaws for holding plastic pipe. The jaws are engineered for use with plastic pipe and provide holding power without damage to the pipe.

### Joining Devices

Pipe and fitting pullers are available, designed specifically for joining large diameter PVC and CPVC pipe and fittings 6 in and larger. These tools are designed to allow the pipe to be inserted to the proper insertion depth, maintain proper alignment during assembly, and hold freshly solvent cemented connections to prevent the fitting from backing off until the initial set time is achieved. The use of these types of tools can also reduce assembly time.

## Joining Techniques

### Solvent Welding

PVC and CPVC piping systems are joined in the field via the proven two-step primer and solvent cement welding process providing a quick, strong, leak-tight seal. GF Piping Systems primer rapidly softens and dissolves the joining surfaces of PVC and CPVC pipe and fittings. The benefit of this priming action is especially noticeable on parts being joined together in cold weather.

GF Piping Systems solvent cement is specially formulated for GF Piping Systems PVC and CPVC piping applications, including applications requiring chemical resistance to caustics such as hypochlorite solutions, mineral acids, aggressive water, and aqueous salt solutions. GF Piping Systems solvent cement is an industrial grade, low VOC emission, heavy-bodied, high-strength solvent cement.

### Safety Precautions

Primer and solvent cement products are flammable and contain chemical solvents; therefore, appropriate safety precautions should be taken. Always read the primer and solvent cement can label before use.

Be aware at all times of good safety practices. Primer and solvent cements for pipe and fittings are flammable, so there should be no smoking or other sources of heat or flame in working or storage areas. Be sure to work only in a well

ventilated place and avoid unnecessary skin contact with all solvents. More detailed safety information is available from SDS (Safety Data Sheets) provided by the manufacturer upon request.

Virtually all solvent cements and primers for plastic pipe are flammable and should not be used or stored near heat, spark, or open flames. Do not smoke during use. Eliminate all ignition sources. Primer and solvent cement cans should be kept closed and stored in cool areas above 40°F (5°C). If cement is stored at a very cold temperature and gels, it can be reconstituted by bringing it into a warm environment, 60°-90°F (16°-32°C), and allowing it to sit for 24 hours. Do not try to artificially heat it. Before use, vigorously shake the solvent cement.

Avoid breathing vapors. They should be used only with adequate ventilation. Explosion-proof general mechanical ventilation or local exhaust is recommended to maintain vapor concentrations below recommended exposure limits. In confined or partially enclosed areas a ventilating device should be used to remove vapors and minimize their inhalation. A NIOSH-approved organic vapor cartridge respirator with full face piece is recommended. Commercially available respirators specially designed to minimize the inhalation of organic vapors can also be used. Containers should be kept tightly closed when not in use and covered as much as possible when in use.

Avoid frequent contact with skin and eyes. Solvents may be absorbed through the skin; wearing PVA coated protected gloves and an impervious apron are recommended. These chemicals may cause eye injury; avoid any contact with eyes. Splash proof chemical goggles are recommended. In case of contact, flush with plenty of water for 15 minutes. If irritation persists, get medical attention. If swallowed, call a physician immediately and follow precautionary statements found on the label of the primer and solvent cement cans. Keep out of reach of children.

Containers should be kept tightly closed when not in use and covered as much as possible when in use. Use of an applicator can with applicator attached to a lid is especially recommended. The date on the bottom of the primer and solvent cement can is the date of manufacture. The shelf life of the products is per Table 4-1.

**Table 4-1: Product shelf life for primer and solvent cement**  
**Product Shelf Life**

Primer	3 Years
Solvent Cement	2 Years

\*Refer to solvent cement safety data sheet (SDS) prior to use.

On projects where plastic pipe is being installed or has recently been solvent welded, special caution should be taken when using welding torches or other equipment where sparks may be involved. Flammable vapors from cemented joints sometimes linger within or around a piping system for

some time. Special care must be taken when installing in elevator shafts or similar applications where fumes could accumulate or when installing pumps.

In all cases, lines should be purged to remove solvent vapors before welding.

**Warning: Use caution with welding torches.**

Do not use a dry, granular calcium hypochlorite as a disinfecting material for water purification in potable water piping systems. The introduction of granules or pellets of calcium hypochlorite with solvent cements and primers (including their vapors) may result in violent chemical reactions if a water solution is not used. It is advisable to purify lines by pumping chlorinated water into the piping system; this solution will be non-volatile. Furthermore, dry granular calcium hypochlorite should not be stored or used near solvent cements or primers.

**Warning: Use caution with calcium hypochlorite.**

### Solvent Cement and Primer Spills

Work areas should be protected by using drop cloths in case of an accidental spill. Solvent cement and/or primer spills can cause irreparable damage depending on the type of surface affected. Accidental spills should be wiped up immediately before the cement sets. A mild soap and water mixture may aid in removal of a stain; however, the use of solvents or harsh cleansers may do more damage than good. In the event of a spill, consult the manufacturer of the affected surface for possible suggestions. Protecting the work area prior to starting is recommended.

**Accidents and injuries have seldom occurred in the use of these products. Help maintain and improve this excellent record by following the above recommendations.**

### Applicators

A wide variety of daubers and swabs are available. Use the appropriate type and size applicator for the materials being joined. It is important to use a proper size applicator. A dauber or swab approximately one-half the size of the pipe diameter being joined is appropriate. The dauber supplied with the primer and solvent cement quart cans is the proper size for use with 2, 2 1/2, and 3 in diameters only. For smaller and larger sizes see Table 4-2.

**Table 4-2: Applicator guide**

Nominal Size	1/2"	3/4"	1"	1 1/4"	1 1/2"	2"	2 1/2"	3"	4"	6"	8"	10"	12"
3/8" Dauber	•	•											
1/2" Dauber		•	•										
3/4" Dauber				•	•								
1 1/2" Dauber						•	•	•					
4" Swab									•	•	•	•	•

### Primers

The use of primer is necessary to penetrate and dissolve the surface of the pipe and fitting prior to the application of solvent cement. Primer must be applied to both pipe and fittings. Apply primer to the fitting socket, then to the outside of the pipe end, then a second coat to the fitting socket; re-dip the applicator as necessary to ensure entire surface is wet.

### Solvent Cements

The cement system used for joining PVC and CPVC is a solvent-based type. The solvent dissolves the mating surfaces when properly applied to each surface. The thermoplastic resin filler contained in the cement assists in filling the gaps between pipes and fitting surfaces. An evaporation retardant slows the rate of evaporation of the prime solvent. Joining of the wet mating surfaces in one minute or less after starting to cement is essential to prevent dry spots that will not bond. The bond interface will consist of a mixture of cement resin and dissolved material from the attached pipe and fitting surfaces. As the solvent evaporates, the interface becomes homogeneous with the pipe and fitting surfaces, except for residual solvent, which dissipates over a period of time. The resultant homogeneous bonded area has led to the term "solvent welded" although no heat is applied to melt and fuse the bonded areas as in metal welding.

**Note: Solvent cement should be applied immediately after primer while the surfaces are still tacky.**

### Basic Principles of Solvent Cementing

The solvent-cemented connection in thermoplastic pipe and fittings is the last vital link in a plastic pipe installation. It can mean the success or failure of the system as a whole. Accordingly, it requires the same professional care and attention that are given to other components of the system. If the basic principles involved are explained, known, and understood, a better understanding is gained as to what techniques are necessary to suit particular applications, temperature conditions, and variations in size and fit of pipe and fittings. Be aware at all times of good safety practices. Solvent cements for pipe and fittings are flammable, so there should be no smoking or other sources of heat or flame in working or storage areas. Be sure to work only in a well-ventilated space and avoid unnecessary skin contact with all solvents. **Refer to Section 4.12 for more information.**

To consistently make good joints, the following should be carefully understood:

1. The joining surfaces must be softened and made semi-fluid.
2. Sufficient cement must be applied to fill the gap between pipe and socket fitting.
3. Assembly of pipe and fittings must be made while the surfaces are still wet and fluid.
4. Joint strength develops as the cement dries. In the tight part of the joint the surfaces will tend to fuse together; in the loose part of the cement will bond to both surfaces.

## Hot Weather

There are many occasions when solvent cementing in 95°F (35°C) temperatures or over cannot be avoided. If a few special precautions are taken, problems can be avoided. Solvent cements contain high-strength solvents which evaporate faster at elevated temperatures. This is especially true when there is a hot wind blowing. If the pipe has been in direct sunlight for any length of time, surface temperatures may be 20°F-30°F (11°C-17°C) above air temperature. Solvents attack these hot surfaces faster and deeper, especially inside a joint. Thus, it is very important to avoid puddling inside sockets and to wipe off excess cement outside. Following are tips to follow when solvent cementing in high temperatures:

1. Store solvent cements in a cool or shaded area prior to use.
2. If possible, store the fittings and pipe, or at least the ends to be solvent welded, in a shady areas before cementing.
3. Cool surfaces to be joined by wiping with a damp rag. Be sure that surfaces are dry prior to applying solvent cement.
4. Try to do the solvent cementing in cooler morning hours.
5. Make sure that both surfaces to be joined are still wet with solvent cement when putting them together.

## Cold Weather

Solvent cement products have excellent cold weather stability and are formulated to have well balanced drying characteristics even in subfreezing temperatures. Good solvent cemented joints can be made in very cold conditions provided proper care and a little common sense are used. In cold weather, solvents penetrate and soften surfaces more slowly than in warm weather. The plastic is also more resistant to solvent attack; therefore, it becomes more important to pre-soften surfaces. Because of slower evaporation, a longer cure time is necessary. The following are some tips to follow when solvent cementing in low temperatures:

1. Prefabricate as much of the system as possible in a heated work area.
2. Store solvent cements in a warmer area above 40°F (4°C) when not in use, and make sure they remain fluid.
3. Take special care to remove moisture including ice and snow.
4. Use special care to ensure joining surfaces are adequately softened; more than one application may be necessary.
5. Allow a longer cure period before the system is used.
6. Follow appropriate set and cure times prior to pressure testing.

## Getting Started

1. Review safety precautions.
2. Review cement and primer can labels.
3. Review assembly instructions.
4. Condition pipe and fittings being joined to the same temperature conditions prior to use.

## Inspection before Use

Pipe and fittings should always be inspected for damage before actual installation. Pipe or pipe fittings with cuts, gouges, scratches, splits, or other signs of damage from improper handling or storage should not be used. Damaged sections on lengths of pipe can easily be cut out using proper techniques for cutting thermoplastic pipe. Always cut at least 6 inches (150 mm) beyond any visible crack.

## Check Material

Make sure the fittings, valves, and pipe being joined are PVC or CPVC from GF Piping Systems. The expansion and contraction features, pressures, etc. among plastics are vastly different and use of materials from different manufacturers could cause failure. The solvent cement should meet all the requirements of Specification D2564 for PVC solvent cement of Specification F493 for CPVC solvent cement. Verify that the primer and solvent cement are within their shelf lives.

## Handling of Cement

Keep cement containers covered while not in use. If the container of cement with the lid off is subjected to prolonged exposure to air, the cement in the can becomes thick and viscous, or gel-like. Chances are, this condition has been brought about by the evaporation of the solvent. If this occurred, the cement is useless. Do not try to restore the cement by stirring in a thinner. For this reason, it is suggested that smaller containers of cement, rather than the large container, be used especially in warm or hot weather. Prior to using an unopened can of cement, shake it vigorously to ensure proper dispersion of the resin and solvents. Keep in mind that the solvents contained in cements are highly flammable and should not be used near an open flame. The area in which the cement is being used should be well ventilated, and prolonged breathing of the fumes should be avoided as well as contact with the skin or eyes. All cement should be handled in the same manner as a very fast-drying lacquer. Verify that the primer and solvent cement are within their shelf lives.

## Estimated Quantities of Solvent Cement

Estimated quantities of cement can vary due to installation conditions, tolerance variations, and socket depths. It is better practice to err on the liberal side than skimp if precautions, as outlined in GF Piping Systems's instructions, are recognized and followed. Field conditions or other factors could occur during installation that have not yet been encountered or addressed in this manual. Consequently, the information contained herein may be considered as a basis for recommendation but not as a guarantee.

Table 4-3 gives an estimate of the quantities of cement required based on pipe diameter. Quantities of primer average half of the cement required quantity.

**Table 4-3: Estimated quantities of primer and cement**

Nominal Size (inch)	Pint			Quart		
	No. of Joints	No. of Couplings or 90s	No. of Tees	No. of Joints	No. of Couplings or 90s	No. of Tees
½	190.0	95.0	64.0	380.0	190.0	128.0
¾	120.0	60.0	40.0	240.0	120.0	80.0
1	100.0	50.0	33.0	200.0	100.0	66.0
1¼	70.0	35.0	24.0	140.0	70.0	48.0
1½	50.0	25.0	17.0	100.0	50.0	34.0
2	30.0	15.0	10.0	60.0	30.0	20.0
2½	25.0	12.0	8.0	50.0	24.0	16.0
3	20.0	10.0	6.0	40.0	20.0	12.0
4	12.0	6.0	4.0	24.0	12.0	8.0
5	9.0	4.5	3.0	18.0	9.0	6.0
6	5.0	2.5	1.7	10.0	5.0	3.3
8	2.5	1.0	0.8	5.0	2.1	1.6

**Caution: Before applying primer and cement, appropriate safety precautions should be taken.**

**Assembly Instructions**

Primer and solvent cement should be stored in the shade between 40°F (5°C) and 110°F (43°C). Eliminate all ignition sources. Avoid breathing vapors. Use only with adequate ventilation; explosion-proof general mechanical ventilation or local exhaust is recommended to maintain vapor concentrations below recommended exposure limits. In confined or partially enclosed areas, a NIOSH-approved organic vapor cartridge respirator with full face piece is recommended. Containers should be kept tightly closed when not in use and covered as much as possible when in use. Avoid frequent contact with the skin; wearing PVA-coated protective gloves and an impervious apron are recommended. Avoid any contact with eyes; splash-proof chemical goggles are recommended. Verify that the primer and solvent cement are within their shelf lives.

Condition the pipe and fittings to the same temperature conditions prior to use. All pipe, fittings, and tools used for joining must be clean and free of dirt, moisture, grease, or other contamination prior to and during the joining process.

**Cutting**

It is important to cut the pipe square. A square cut provides the surface of the pipe with the maximum bonding area. Pipe can be easily cut with a wheel-type plastic pipe cutter, power saw, chop saw, or fine-toothed saw. Proper PPE must be used. GF Piping Systems does NOT recommend the use of ratchet cutters as they may split the pipe during cutting. Tools used to cut pipe must be designed for use with plastics and must be in good condition in accordance with the tool manufacturer’s recommendations. If there is any indication

of damage or evidence of cracking on the pipe, cut off at least 6 in (152 mm) beyond any visible crack.

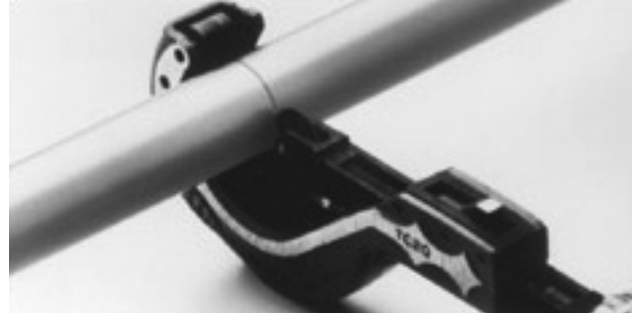

**Bevel/Deburr**

Burrs and filings can prevent proper contact between pipe and fitting during insertion or assembly and must be removed from the outside and inside of the cut pipe. A chamfering tool or a file is suitable for this purpose. A slight bevel (approximately 10°–15° chamfer) and a minimum width of 3/32 in (2.5 mm) shall be placed at the end of the pipe to ease entry of the pipe into the fitting socket. This will minimize the chance that the edges of the pipe will wipe solvent cement or will scrape softened surface material from the fitting socket during the insertion of the pipe.



- 5/64" (2.0mm) min. for ½"–2" pipe
- 3/32" (2.5mm) min. for 2½"–3" pipe
- ¼" (6.4mm) min. for 4"–12" pipe
- 1½" (38mm) min. for 14"–24" pipe

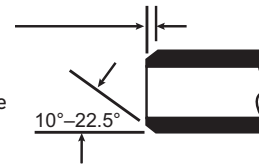

**Joining Preparation**

Using a clean, dry rag, wipe any dirt and moisture from the fitting socket and pipe end. Moisture will slow the cure time, and dirt and/or grease will prevent weld adhesion. A cleaner is recommended if the pipe end or fitting socket is excessively dirty or greasy. After cleaning, check pipe and fitting for possible damage, such as splits or cracks, and replace if necessary.

Prior to cementing, measure the socket depth and mark the pipe. Then mark the pipe again 2 in (50 mm) from the first mark. The first mark may later be removed during the cleaning or cementing process. The purpose of making the second mark on the pipe is to ensure the pipe has been fully inserted during the cementing process. After joining, the distance from the fitting to the second mark should be 2 in (50 mm). Test the dry fit of the joint. For proper interference fit, the fitting should go over the end of the pipe easily but become tight about 1/3 to 2/3 of the socket depth. Do NOT force the pipe to bottom out in the socket.

## Primer Application

The purpose of a primer is to penetrate and soften the surfaces so they can fuse, or weld, together. Because joining occurs in a wide variety of conditions, it is important to check for sufficient softening of the pipe. Check the penetration, or softening, on a piece of scrap pipe before you start the installation or if the weather changes during the day. Using a knife or other sharp object, drag the edge over the coated surface. Proper penetration has been made if you can scrape a few thousandths of the primed surface away. Weather conditions can affect priming and cementing action, so be aware of the following:

1. Repeated applications to either or both surfaces may be necessary.
2. In cold weather, more time may be required for proper penetration.
3. In hot weather, penetration time may be shortened due to rapid evaporation.

Using the correct applicator, aggressively work the primer into the fitting socket, keeping the surface and applicator wet until the surface has been softened. More applications may be needed in cold weather conditions. Re-dip the applicator in primer as required. When the surface is primed, drain any puddles of primer from the socket. Next, aggressively work the primer onto the end of the pipe to a point  $\frac{1}{2}$  in (13 mm) beyond the mark you made for the depth of the fitting socket. Then, work a second coat of primer into the fitting socket. Immediately, while the surfaces are still wet, move to the next step.

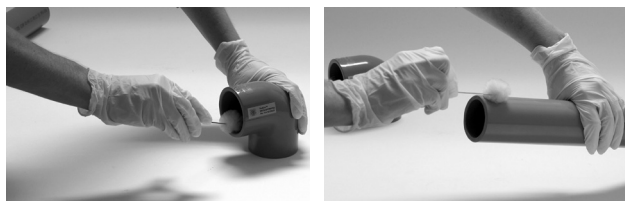

## Solvent Cement Application

Using the correct applicator, apply a full, even layer of cement on the pipe end equal to the depth of the fitting socket. Do not brush it out too thin as this will dry within a few seconds. Work a medium layer of cement into the fitting socket; avoid excess cement from puddling or running beyond the socket depth. Apply a second, even layer of cement on the pipe. Immediately, while the surfaces are still wet, move to the next step.

## Assembly

If the solvent cement is not completely wet, re-coat parts before assembly. If solvent cement coatings have hardened, cut pipe, dispose of fitting, and start over. Do NOT assemble partially cured surfaces. Immediately, while solvent cement is still wet, assemble the pipe and fittings with one smooth insertion action, not stopping until the pipe is completely bottomed out to the fitting pipe stop. If possible, twist the pipe a  $\frac{1}{4}$  turn as you insert it into the fitting socket.

For  $\frac{1}{2}$ " - 3" joints, hold the pipe and fitting together for a minimum of 30 seconds or 90 seconds minimum for 4" and larger joints to avoid push out and allow the fusion weld to form. Using a rag, remove the excess solvent cement from the pipe and fitting as it will needlessly soften the pipe and fitting, does not add to the joint strength, and will extend the cure time.

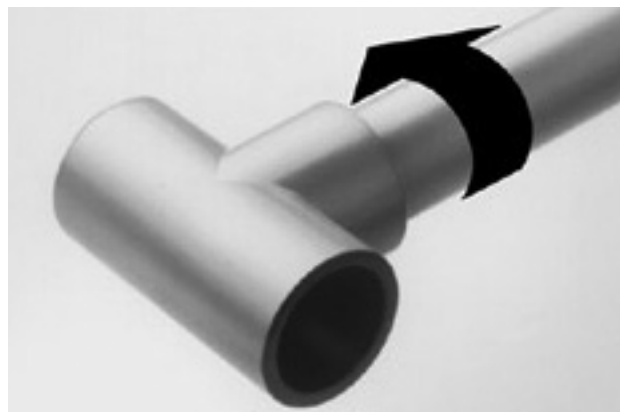

Avoid disturbing or moving the joint until the initial set time has been reached. Do not pressure test until the cure time for the test pressure has been reached. See Table 4-4 and Table 4-5 for set and cure times.

## Set and Cure Times

The joint should not be disturbed immediately after the cementing procedure until the initial set time has passed. Exact curing time is difficult to predict because it depends on variables such as temperature, humidity, and cement integrity.

**Table 4-4 and Table 4-5 show a guideline for initial set and cure times.**

**Table 4-4: Initial set times**

Temperature range (relative humidity 60% or less)		Pipe Sizes				
°F	°C	$\frac{1}{2}$ " to 1 $\frac{1}{4}$ "	1 $\frac{1}{2}$ " to 2"	2 $\frac{1}{2}$ " to 8"	10" to 14"	16" to 24"
61°–100°	16°–38°	2 min	5 min	30 min	2 hr	4 hr
41°–60°	5°C–16°	5 min	10 min	2 hr	8 hr	16 hr
0°–40°	-18°–5°	10 min	15 min	12 hr	24 hr	48 hr



**Table 4-5: Initial cure times**

Relative Humidity > 60%		Pipe Sizes							
Temp. Range		½" to 1¼"		1½" to 2"		2½" to 8"		10" to 14"	16" to 24"
°F	°C	up to 160 psi (11 bar)	161-370 psi (11-26 bar)	up to 160 psi (11 bar)	161-370 psi (11-26 bar)	up to 160 psi (11 bar)	161-370 psi (11-26 bar)	up to 100 psi (7 bar)	up to 100 psi (7 bar)
61°–100°	16°–38°	15 min	6 hrs	30 min	12 hrs	90 min	24 hrs	2 days	3 days
41°–60°	5°–16°	20 min	12 hrs	45 min	24 hrs	4 hrs	48 hrs	4 days	6 days
0°–40°	-18°–5°	30 min	48 hrs	60 min	96 hrs	72 hrs	8 days	8 days	14 days

Note: The sure schedules are based on laboratory test data obtained on net fit joints. Net fit joints are defined as a joint that, in a dry fit, the pipe bottoms snugly in the fitting socket without meeting interference).

### Techniques to Ensure Strong Joints

Installers should verify for themselves that they can make satisfactory joints under varying conditions and should receive training in installation and safety procedures.

*Consult GF Piping Systems assembly instructions, Safety Data Sheets, ASTM D2855 Standard Practice for the Two-Step (Primer and Solvent Cement) Method of Joining Poly (Vinyl Chloride) (PVC) or Chlorinated Poly (Vinyl Chloride) (CPVC) Pipe and Piping Components with Tapered Sockets, and ASTM F402 Standard Practice for Safe Handling of Solvent Cements, Primers, and Cleaners Used for Joining Thermoplastic Pipe and Fittings.*

**Note: Follow appropriate cure times prior to pressure testing.**

Heavy-bodied cements are successfully used in place of the lighter cements. There have been more field problems created using the lighter and quicker drying cements on larger and heavier-walled pipe, than using heavy-bodied cements on lighter-walled and small-diameter pipe. It is extremely difficult to get a satisfactory bond in the first case and quite easy with reasonable care in the second. More care should be used in cementing fitting sockets and avoiding puddling of cement or primer within the components being joined. Puddling causes excess softening of the material and could cause damage to the product, especially in small-diameter pipe. Maximum or somewhere extended cure times should also be followed with the heavy-bodied cements.

The cement should still be wet when the surfaces are mated. In certain cases, difficult areas may extend cement-to-joining times to the upper one-minute limit. A check should be made with the cement supplied to ensure it will provide a still wet surface for at least one full minute with a normal full coat under the actual field conditions. This can be done by preparing a scrap piece of pipe with the primer, applying a full, even coating stroke with the solvent cement applicator, and checking to see if the cement is still wet after one full minute.

### Joint Evaluation

Good PVC and CPVC solvent joints exhibit a complete dull surface on both surfaces when cut in half and pried apart. Leaky joints will show a continuous or an almost continuous series of un-fused areas (shiny spots) or channels from the socket bottom to the outer lip of the fitting. No bond occurred at these shiny spots. This condition can increase to the point

where almost the entire cemented area is shiny, and fittings can blow off at this point.

Un-fused areas can be attributed to one or a combination of the following causes:

1. Use of the wrong size applicator (insufficient cement application),
2. Use of a cement that has partially or completely dried prior to bottoming of the fitting,
3. Use of a gelled cement that will not bite into the pipe and fitting surfaces due to loss of the prime solvent,
4. Insufficient cement or cement applied to only one surface,
5. Excess gap, which cannot be satisfactorily filled,
6. Excess time taken to make the joint after the start of the cement application. In many of these cases, as well as condition 1 or 2 above, examination will show that it was impossible to bottom the fitting since the lubrication effect of the cement had dissipated,
7. Cementing with pipe surfaces above 110°F (43°C) caused too much of the prime solvent to evaporate,
8. Cementing with cement that has water added by one means or another, or excess humidity conditions coupled with low temperatures,
9. Joints that have been disturbed and the bond broken prior to a firm set, or readjusted for alignment after bottoming,
10. Cementing surface not properly primed and dissolved prior to applying solvent cement, and/or
11. Improper component preparation including
  - a. Lack of a bevel on the pipe end, or an insufficient bevel, which will cause the inserted pipe to scrape solvent from the socket wall of the fitting during assembly,
  - b. Failure to deburr; the presence of filings and shavings can create weak spots within the assembled components resulting in un-fused areas, and
  - c. Failure to cut the pipe end square which will reduce the surface area of the solvent cemented assembly in the critical area of the joint (socket bottom).

### Tolerances and Fits

GF Piping Systems PVC and CPVC pipe and fittings are manufactured in accordance with applicable ASTM Standards to produce an interference fit when assembled. Test the dry fit of the parts to be joined for proper interference fit. The pipe should insert easily into the fitting socket but become tight

about 1/3 to 2/3 of socket depth. However, this condition can vary because of minimum and maximum allowable tolerances permitted by the standards to which the pipe and fittings are produced.

In the case of a fitting with a maximum diameter and a pipe with a minimum diameter, a loose fit could result. Applying two coats of solvent cement or using a heavier bodied cement under these conditions will help ensure a good joint. Conversely, if the pipe diameter is on the maximum side and the fitting on the minimum side, the interference may be too great, and sanding of the pipe outer diameter to permit entrance may be necessary. In either extreme case, it is recommended to contact GF technical support for possible corrective actions.

For these specific reasons, it is important to check dry fits prior to making a solvent welded joint. Schedule 40 pipe has a tendency to round itself within the Schedule 40 fittings, thus permitting a greater degree of interference. However, in the case of Schedule 80 and 120 fittings, the heavy wall on the pipe will cause the pipe to be non-roundable. Interference can be less on large diameter, Schedule 80 and 120 fittings (particularly fabricated fittings) which in many cases will allow the pipe to be dry fit to the pipe stop with very little interference. It is under these conditions that it may be necessary to use an extra heavy-bodied solvent cement and to apply more than one coat to the pipe and fitting if the dry-fit seems loose. Prior to assembly, all piping system components should be inspected for damage or irregularities. Mating components should be checked to assure that tolerances and engagements are compatible. Do not use any components that appear irregular or do not fit properly. Contact the appropriate manufacturer of the product in question to determine usability.

### Belled End Pipe

In many installations, belled end pipe can be used to eliminate the need for couplings. Where belled end pipe is used, it is suggested that the interior surface of the bell be penetrated exceptionally well with the primer. Table 4 6 below gives the dimensions for GF Piping Systems belled end pipe.

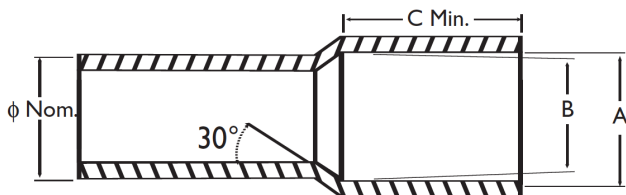

Table 4-6: Belled-end pipe dimensions

Nominal OD (in)	A		B		C
	Min. (in)	Max. (in)	Min. (in)	Max. (in)	Min. (in)
1¼	1.675	1.680	1.648	1.658	1.870
1½	1.905	1.914	1.880	1.888	2.000
2	2.381	2.393	2.363	2.375	2.250
2½	2.882	2.896	2.861	2.875	2.500
3	3.508	3.524	3.484	3.500	3.250
4	4.509	4.527	4.482	4.500	4.000
5	5.573	5.593	5.543	5.563	4.000
6	6.636	6.658	6.603	6.625	6.000
8	8.640	8.670	8.595	8.625	6.000
10	10.761	10.791	10.722	10.752	8.000
12	12.763	12.793	12.721	12.751	8.500
14	14.030	14.045	13.985	14.000	9.000
16	16.037	16.052	15.985	16.000	10.000
18	18.041	18.056	17.985	18.000	12.000
20	20.045	20.060	19.985	20.000	12.000
24	24.060	24.075	24.000	24.015	14.000

Nominal OD (in)	A		B		C
	Min. (mm)	Max. (mm)	Min. (mm)	Max. (mm)	Min. (mm)
1¼	42.5	42.7	41.9	42.1	47.5
1½	48.4	48.6	47.8	48.0	50.8
2	60.5	60.8	60.0	60.3	57.2
2½	73.2	73.6	72.7	73.0	63.5
3	89.1	89.5	88.5	88.9	82.6
4	114.5	115.0	113.8	114.3	101.6
5	141.6	142.1	140.8	141.3	101.6
6	168.6	169.1	167.7	168.3	152.4
8	219.5	220.2	218.3	219.1	152.4
10	273.3	274.1	272.3	273.1	203.2
12	324.2	324.9	323.1	323.9	215.9
14	356.4	356.7	355.2	355.6	228.6
16	407.3	407.7	406.0	406.4	254.0
18	458.2	458.6	456.8	457.2	304.8
20	509.1	509.5	507.6	508.0	304.8
24	611.1	611.5	609.6	610.0	355.6

**Note: GF Piping Systems does not use silicone lubricants in the belling process. However, some manufacturers use a silicone release agent on the belling plug, and a residue of this agent can remain inside the bell. This residue must be removed in the cleaning process prior to solvent cementing.**

### Large Diameter Pipe

The basic solvent cement instructions apply to all sizes of pipe, but when making joints 4 in and above, the use of two people to apply the solvent cement simultaneously to pipe and fitting is recommended. Additional people should also be in a position to help push the pipe into the fitting socket while the cemented surfaces are still wet and ready for insertion. Alignment of large diameter pipe and fittings is much more critical than when working with small diameter pipe. Specialty large diameter joining tools, developed specifically for joining large diameter PVC and CPVC piping products, are available.

It is imperative to use the appropriate size applicator for the application of primer and cement when working with large diameter pipe. Use a roller approximately one-half the size of the diameter of pipe being joined. As the pipe diameters increase, the range of tolerances also increases which can result in out-of-round and gap conditions. Speed in making the joint and applications of heavy coats of solvent cement in these cases is important. When working with pipe diameters such as 8 in through 24 in, checking the dry fit of the pipe and fittings is more critical on these large sizes. In many cases, where fabricated fittings are used, interference fits may not be present; consequently, it will be necessary to apply more than one coat of cement to the pipe and fitting. It is essential to use a heavy-bodied and/or extra heavy-bodied, slow drying cement on these large diameter sizes.

### Joining by NPT Threads

While threaded thermoplastic systems are not recommended for high pressure systems, piping layouts where leaks would be dangerous, or for larger pipe sizes (more

than 4 in), they have two definite advantages. They can quickly be dismantled for temporary or take-down applications, and they can be used to join thermoplastic to non-plastic materials. Theoretically, it is possible to use any combination of threaded parts, such as:

1. Metal female to thermoplastic male
2. Thermoplastic male to thermoplastic female
3. Metal male to thermoplastic female (should not be used)

A male plastic thread can be inserted into a female metal thread if heat is not involved and both lines are anchored immediately adjacent to the joint. However, male metal threads should NOT be connected to a female plastic pipe thread, item 3 above. The reason for this is due to the incompressibility of metal in relation to thermoplastics.

Figure 4-1, Table 4-7, and Table 4-8 below show thread dimensions for your reference.

**Figure 4-1: Dimensions of pipe threads as shown in below tables**

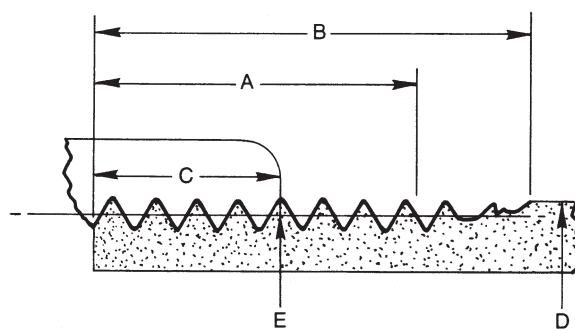

**Table 4-7: American standard taper pipe thread dimensions in Imperial units**

Pipe		Thread					
Nominal Size (in)	Outside Diameter (in)	Threads per inch	Normal engagement by Hand (in)	Length of Effective Thread (in)	Total Length end of pipe to Vanish Point (in)	Pitch Diameter at end of Internal Thread (in)	Depth of Thread (max.)(in)
	D		C	A	B	E	
½"	0.840	14	0.320	0.5337	0.7815	0.77843	0.05714
¾"	1.050	14	0.339	0.5457	0.7935	0.98887	0.05714
1"	1.315	11.5	0.400	0.6828	0.9845	1.23863	0.06957
1¼"	1.660	11.5	0.420	0.7068	1.0085	1.58338	0.06957
1½"	1.900	11.5	0.420	0.7235	1.0252	1.82234	0.06957
2"	2.375	11.5	0.436	0.7565	1.0582	2.29627	0.06957
2½"	2.875	8	0.682	1.1375	1.5712	2.76216	0.10000
3"	3.500	8	0.766	1.2000	1.6337	3.38850	0.10000
4"	4.500	8	0.844	1.3000	1.7337	4.38713	0.10000
6"	6.625	8	0.958	1.5125	1.9472	6.50597	0.10000
8"	8.625	8	1.063	1.7125	2.1462	8.50003	0.10000
10"	10.750	8	1.210	1.9250	2.3587	10.62094	0.10000
12"	12.750	8	1.360	2.1250	2.5587	12.61781	0.10000

**Table 4-8: American standard taper pipe thread dimensions in Metric units**

Pipe		Thread					
Nominal Size (in)	Outside Diameter (mm)	Threads per mm	Normal engagement by Hand (mm)	Length of Effective Thread (mm)	Total Length end of pipe to Vanish Point (mm)	Pitch Diameter at end of Internal Thread (mm)	Depth of Thread (max.)(mm)
	D		C	A	B	E	
½"	21.3	355.6	8.13	13.56	19.85	19.772	1.451
¾"	28.7	355.6	8.61	13.86	20.15	25.117	1.451
1"	33.4	292.1	10.16	17.34	25.01	31.461	1.767
1¼"	42.2	292.1	10.67	17.95	25.62	40.218	1.767
1½"	48.3	292.1	10.67	18.38	28.04	48.287	1.767
2"	60.3	292.1	11.07	19.22	28.88	58.325	1.767
2½"	73.0	203.2	17.32	28.89	39.91	70.159	2.540
3"	88.9	203.2	19.46	30.48	41.50	88.068	2.540
4"	114.3	203.2	21.44	33.02	44.04	111.433	2.540
6"	168.3	203.2	24.33	38.42	49.46	165.252	2.540
8"	219.1	203.2	27.00	43.50	54.51	215.901	2.540
10"	273.1	203.2	30.73	48.90	59.91	269.772	2.540
12"	323.9	203.2	34.54	53.98	64.99	320.492	2.540

**Threaded Connections**

Please read all instructions before attempting to install threaded parts.

NPT threaded connections are not recommended for high pressure or high temperature systems, systems greater than 4" in diameter, or systems where leaks would be dangerous or costly. When properly installed, threaded connections offer the benefit of an easy and inexpensive transition to metal systems. They can also be used for joining plastic where the installation is expected to be modified or moved later.

Due to the difference in stiffness between plastic and metal, a metal male to thermoplastic female joint should be avoided if possible. Threading reduces the rated pressure of the pipe by one-half.

**Thread Sealant**

Use either a thread sealant (pipe dope) approved for use with thermoplastics, or PTFE tape, but not both, to seal threads. Use a thin, even coat of sealant. PTFE tape must be installed in a clockwise direction starting at the bottom of the thread and overlapping each pass. Do not employ more than three wraps.



Pipe Dope



PTFE Thread Sealant

**Making the Connection**

Start the threaded connection carefully by hand to avoid cross threading or damaging threads. Turn until hand tight. Mark the location with a marker. With a strap wrench on the plastic part, turn an additional half turn.

If leakage occurs during pressure testing, consult Table 4-9 for next steps.

**Table 4-9: Steps to compensate for leakage during pressure testing**

Connection Type	Next Step
Thermoplastic to Thermoplastic	Tighten up to ½ turn
Thermoplastic Male to Metal Female	Tighten up to ½ turn
Metal Male to Thermoplastic Female	Consult Factory

Threaded connections are susceptible to fracture or leaking due to misalignment. Pipe should be installed without bending. See Page 65 for information on guides and support spacing and Page 23 for allowances for thermal expansion.

**Joining by Van Stone Flanges**

Please read all instructions before attempting to install flanges.

Like all thermoplastic pipe and fittings, the flanges are light-weight, inexpensive, and easy to install. However, thermoplastics have different physical properties than metals; therefore, special care is required to ensure that your flanges have a long, reliable service life. Installers should study these instructions and follow them carefully in every installation in order to ensure satisfactory performance and enjoy the full benefits of the GF Piping Systems warranty.

Flanges are generally used when

1. The piping system may need to be dismantled,
2. The installation is temporary or mobile,
3. Transitioning between dissimilar materials that cannot be cemented together, and/or
4. The installation environment is not conducive to solvent cementing.

## Gaskets

Visually inspect flanges for cracks, deformities, solvent cement, and other obstructions on the sealing surfaces.

**Table 4-10: Gasket dimensions**

Size (inch)	Minimum OD		Maximum ID	
	inch	mm	inch	mm
1/2"	3.5	88.9	0.88	22.4
3/4"	3.88	98.6	1.10	27.9
1"	4.25	108.0	1.38	35.1
1 1/4"	4.63	118.0	1.60	40.6
1 1/2"	5.00	127.0	1.93	49.0
2"	6.00	152.0	2.44	62.0
2 1/2"	7.00	178.0	2.91	73.9
3"	7.50	191.0	3.59	91.2
4"	9.00	229.0	4.64	118.0
6"	11.00	279.0	6.82	173.0
8"	13.50	343.0	8.66	220.0
10"	16.00	406.0	10.81	275.0
12"	19.00	483.0	12.09	307.0

**Figure 4-2: Dimension Labels**

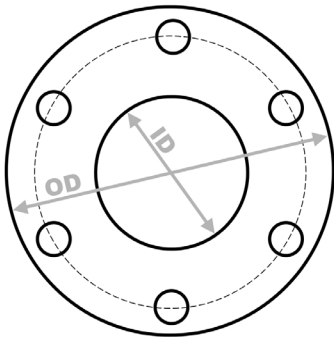

A rubber gasket must be used between the flange faces in order to ensure a good seal. For PVC and CPVC flanges, GF Piping Systems recommends a 0.125 in thick, full-face gasket with a Shore A scale hardness of 70±5, and the bolt torque values shown on the table (page 61) "Flange Bolt Torque" are based on this specification. For other hardness requirements, contact GF Technical Services. Select the gasket material based on the chemical resistance requirements of your system. A full-face gasket should cover the entire flange-to-flange interface without extending into the flow path. Table 4-10 gives required gasket dimensions for GF Piping Systems Van Stone Flanges.

## Fasteners

It is critical to avoid excessive compression stress on the Van Stone Flange. Therefore, only low-friction fastener materials should be used. Low-friction materials allow torque to be applied easily and gradually, ensuring that the flanges are not subjected to sudden, uneven stress during installation which can lead to cracking.

Either the bolt or the nut, but preferably both, should be zinc-plated to ensure minimal friction. If using stainless steel bolts and nuts, lubricant must be used to prevent high friction and seizing. In summary, the following fastener combinations are acceptable:

1. Zinc-on-zinc, with or without lubricant;
2. Zinc-on-stainless steel, with or without lubricant; or
3. Stainless steel-on-Stainless steel, with lubricant only.

Cadmium plated fasteners, while becoming more difficult to obtain due to environmental concerns, are also acceptable with or without lubricant. Galvanized and carbon steel fasteners are not recommended. Use a copper-graphite anti-seize lubricant to ensure smooth engagement and the ability to disassemble and reassemble the system easily. Note the fastener specifications in Table 4-11.

**Table 4-11: Fastener Specifications**

Flange Size (in)	No. of Bolts	Length (in)	Bolt Size (in)-Type	Washer Size (in)-Type
1/2"	4	2 1/2"	1/2-UNC	1/2 SAE <sup>3</sup>
3/4"	4	2 1/2"	1/2-UNC	1/2 SAE
1"	4	2 3/4"	1/2-UNC	1/2 SAE
1 1/4"	4	2 3/4"	1/2-UNC	1/2 SAE
1 1/2"	4	3 1/4"	1/2-UNC	1/2 SAE
2"	4	3 1/2"	5/8-UNC	5/8 SAE
2 1/2"	4	4"	5/8-UNC	5/8 SAE
3"	4	4"	5/8-UNC	5/8 SAE
4"	8	4 1/4"	5/8-UNC	5/8 SAE
6"	8	4 1/2"	3/4-UNC	3/4 SAE
8"	8	5"	3/4-UNC	3/4 SAE
10"	12	5"	7/8-UNC	7/8 SAE
12"	12	5"	7/8-UNC	7/8 SAE
14"	12	5 1/2"	1-UNC	1 SAE
16"	16	5 1/2"	1-UNC	1 SAE
18"	16	5 1/2"	1 1/8-UNC	1 1/8 SAE
20"	20	6"	1 1/8-UNC	1 1/8 SAE
24"	20	6 1/2"	1 1/4-UNC	1 1/4 SAE

1. Suggested bolt length for flange-to-flange connection with 0.125" thick gasket. Adjust bolt length as required for other types of connections.
2. Minimum spec. Use of a stronger or thicker washer is always acceptable as long as published torque limits are observed.
3. Also known as Type A Plain Washers, Narrow Series.
4. ASTM F436 required for larger sizes to prevent warping at high torque.

Bolts must be long enough that two complete threads are exposed when the nut is tightened by hand. Using a longer bolt does not compromise the integrity of the flange connection, although it wastes material and may make tightening more difficult due to interference with nearby system components.

**Figure 4-3: Illustration of exposed threads**

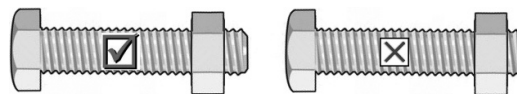

**Figure 4-4: Bolt hole configurations**

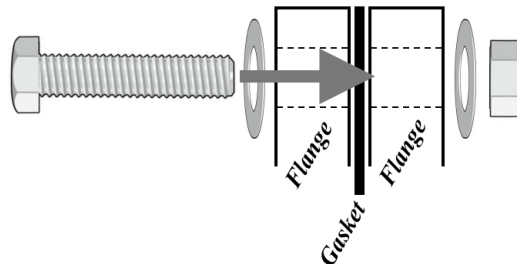



A washer must be used under each bolt head and nut. The purpose of the washer is to distribute pressure over a wider area, reducing the compression stress under the bolt head and nut. Failure to use washers voids the GF Piping Systems warranty.

### Torque Wrench

Compared to metals, thermoplastics are relatively flexible and deform slightly under stress. Therefore, not only must bolt torque be controlled in order to avoid cracking the flange, but continuing to tighten the bolts beyond the recommended torque levels may actually make the seal worse, not better.

Because bolt torque is critical to the proper function of a flange, a current, calibrated torque wrench accurate to within  $\pm 1$  ft-lb must be used when installing flanges.

Experienced installers may be tempted to forego the use of a torque wrench, relying instead on feel. GF Piping Systems does not endorse this practice. Job-site studies have shown that experienced installers are only slightly better than new trainees at estimating bolt torque by feel. A torque wrench is always recommended.

**Note: Never use an impact wrench to install a GF Piping Systems flange.**

### Checking System Alignment

Before assembling the flange, be sure that the two parts of the system being joined are properly aligned. GF Piping Systems has developed a “pinch test” that allows the installer to assess system alignment quickly and easily with minimal tools.

First, check the gap between flange faces by pinching the two mating components toward each other with one hand as shown in Figure 4-5. If the faces can be made to touch, then the gap between them is acceptable.

Next, check the angle between the flange faces. If the faces are completely flush when pinched together, as shown in Figure 4-5, then the alignment is perfect, and you may continue installation. Otherwise, pinch the faces together so that one side is touching; then, measure the gap between the faces on the opposite side. The gap should be no more than  $\frac{1}{8}$  in (3.2 mm).

To assess high-low misalignment, pull the flange faces flush together. If the faces are concentric within  $\frac{1}{8}$  in (3.2 mm), then the high-low misalignment is acceptable.

If the gap between the mating components cannot be closed by pinching them with one hand or if the angle or high-low misalignment between them is too large, then using the bolts to force the components together will result in excessive stress and possible failure during or after installation. In this case, inspect the system to find the greatest source of misalignment and refit the system with proper alignment before bolting.

The pinch test is a good rule of thumb, but always use common sense as well. If it seems difficult or awkward to pull the flange faces together, then stop the installation and either refit the system or consult your GF Piping Systems representative before proceeding.

Figure 4-5: Checking system alignment

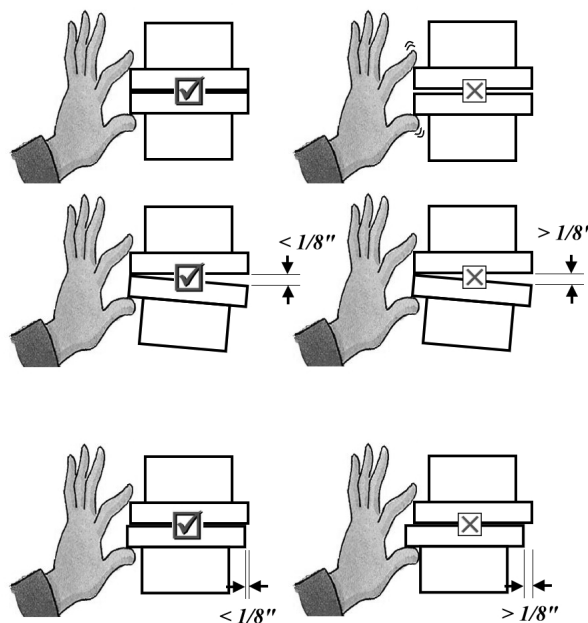

The bolt holes of a Van Stone flange will align automatically when the bolts are inserted and tightened. No additional adjustment is necessary. To align the bolt holes of a fixed flange, use standard two-holing procedure.

### Placing the Gasket

Center the gasket between the flange faces with the bolt holes aligned with corresponding holes in the gasket. A full-face gasket cut to the specified dimensions should come just to the inner edge of the flange face near the flow path or overlap the edge slightly. See Table 4-10 for the specified dimensions.

### Inserting the Bolts

If using copper-graphite anti-seize lubricant as recommended, apply the lubricant evenly with a brush directly to the bolt threads, and to the nut if desired. Cover the bolt from its tip to the maximum extent to which the nut will be threaded. Insert bolts through washers and bolt holes as shown in Figure 4-4.

Tighten all nuts by hand. As you tighten each nut, the nuts on the other bolts will loosen slightly. Continue to hand-tighten all of the nuts until none remain loose. Now the flange assembly will remain in place as you prepare to fully tighten it.

Again, when hand-tightened, at least two threads beyond the nut should be exposed in order to ensure permanent engagement as shown in Figure 4-3. If less than two threads are exposed, disassemble the flange and use longer bolts.

## Hand-Tightening for All Sizes

The next step is to hand-tighten the union nut. With the O-ring in place, engage the nut with its mating threads and turn clockwise with one hand. Continue turning with moderate force until the nut no longer turns. Be careful to use reasonable force when tightening the nut. Your grip should be firm but not aggressive. The nut should turn easily until it bottoms out and brings the mating faces into direct contact.

It is recommended that you place an indexing mark with a permanent marker on the union nut and bolt to identify the hand-tight position. See Figure 4-8 for more details. Union and true union ball valve sizes  $\frac{3}{8}$  in through  $1\frac{1}{2}$  in should be sufficiently sealed after hand-tightening for the hydrostatic pressure test of the system.

Note: Do not use any form of lubricant on the threads of the union nut.

Figure 4-8: Example of an indexing mark



## Optional Further Tightening for Sizes 2 in to 4 in

Based on experience or system requirements, the installer may choose to turn the nut an additional  $\frac{1}{8}$  turn in order to ensure a better seal before hydrostatically pressure testing the system. To do this, use a strap wrench to turn the nut  $\frac{1}{8}$  turn past the index mark applied after assembly.

Do not use any metallic tools. Tool marks on the union nut will void the manufacturer's warranty. At this point, the system should be hydrostatically pressure tested before turning the union nut any further.

## Post-Test Tightening (Sizes $\frac{1}{2}$ in to $1\frac{1}{2}$ in Only)

It is highly unlikely that any union nut connection, when tightened as instructed above, will leak under normal operating conditions. In the unlikely event that a leak occurs, the union nut at the leaking joint may be tightened an additional  $\frac{1}{8}$  turn as described in Table 4-13. The system should then be retested.

Table 4-13: Tightening guide for union and ball valve nuts

Size (in)	Initial	Additional, Pre-Test	Additional, Post-Test
$\frac{1}{2}$	Hand-Tight	None	$\frac{1}{8}$ Turn Max
$\frac{3}{4}$	Hand-Tight	None	$\frac{1}{8}$ Turn Max
1	Hand-Tight	None	$\frac{1}{8}$ Turn Max
$1\frac{1}{4}$	Hand-Tight	None	$\frac{1}{8}$ Turn Max
$1\frac{1}{2}$	Hand-Tight	None	$\frac{1}{8}$ Turn Max
2	Hand-Tight	$\frac{1}{8}$ Turn Max	Consult Factory
3	Hand-Tight	$\frac{1}{8}$ Turn Max	Consult Factory
4	Hand-Tight	$\frac{1}{8}$ Turn Max	Consult Factory

**Note: If the joint still leaks after post-test tightening, do not continue to tighten the nut at the leaking joint. Disassemble the leaking joint, recheck the system alignment, and check for obstructions in the sealing area.**

If the cause of a leak cannot be determined or if you suspect that the union or valve is defective, contact your GF Piping Systems representative for further instructions.

## Quality Check after Assembly

To check if the union connections are installed in a stress-free manner, GF Piping Systems recommends that a random check of alignment be done by removing the nut on selected union connections one at a time. A properly installed system will not have any movement of the piping as the nut is loosened. If any springing action is noticed, steps should be taken to remove the stress prior to re-installing the union nut.

## Documentation

Keep instructions available, and provide a copy of these instructions to every installer on the job site prior to beginning installation.

Best practices include tagging each union with

1. Installer's initials
2. Installation date

This information can be recorded on pre-printed stickers, shown in Figure 4 9, and placed on each union nut immediately after installation.

Figure 4-9: Example of installation card

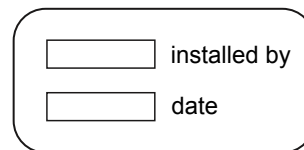

Experience has shown that installation tags speed up the process of resolving system leaks and product failures, improve communication between the contractor and distributor or manufacturer, highlight training opportunities, and promote worker diligence.



## Documentation

Keep instructions available and provide a copy of these instructions to every installer on the job site prior to beginning installation. Installers who have worked primarily with metal flanges often make critical mistakes when installing plastic flanges. Even experienced installers will benefit from a quick review of good installation practices before starting a new job.

Best practices include tagging each flange with installation tags including

1. Installer's initials
2. Installation date
3. Final torque value
4. Confirmation of 24 hour torque check

The information can be recorded on pre-printed stickers as shown in Figure 4-7 and placed on each flange immediately after installation.

**Figure 4-7: Example installation tag**

<input type="text"/>	installed by
<input type="text"/>	date
<input type="text"/>	final torque (ft-lb)
<input type="text"/>	24-hour check

Experience has shown that installation tags speed up the process of resolving system leaks and product failures, improve communication between the contractor and distributor or manufacturer, highlight training opportunities, and promote worker diligence.

## Specialty Adapters

Specialty reinforced molded female adapters are available in PVC and CPVC for use as transition fittings to change materials. Unlike conventional plastic female adapters, these fittings incorporate the use of a stainless steel restraining collar located on the exterior of the FIPT threads of the adapter. This design allows direct connection to male metal threads without the need for pressure derating normally associated with conventional FIPT adapters, as the radial stress generated by thread engagement is contained. In addition, this style of fitting also helps to compensate for stresses that may be generated as the result of differences in dissimilar material, thermal expansion/contraction rates, and related stresses.

## Installing Unions and True Union Ball Valves

Please read all instructions before attempting to install unions or valves.

Because unions and ball valves have similar threaded nut connectors, these instructions have been written with both of these components in mind. GF Piping Systems unions and

true union ball valves are designed to provide many years of service when installed properly.

As with any piping system components, unions and valves have particular considerations that must be kept in mind during installation in order to ensure best performance. Even experienced installers will benefit from reviewing these instructions before each installation.

## Valve Support

Ball valves must be well supported. An unsupported or insufficiently supported valve body will twist when opened and closed, subjecting the union connection to torque stress that may cause cracking or distortion and subsequent leakage.

## System Alignment

The major contributor to union nut failures is misalignment. Uneven compression of the O-ring will cause leaks to occur. Union nuts can be damaged by the stress of holding a misaligned system together. GF union connections use an O-ring as the sealing mechanism, which is highly effective under relatively low tightening force. An often overlooked issue is the presence of dirt and debris on the O-ring or sealing surface. This will prevent proper O-ring sealing; if it is present on the nut body threads, it will clog the threads and prevent proper tightening.

**Note: Never use any foreign substance or object to hold the O-ring in place. Never use the union nuts to draw together any gaps between the mating faces of the components or to correct any system misalignment.**

## Installation

Understand and carefully follow these installation steps in order to ensure a seal that is sufficient to guard against leaks while avoiding excessive forces that can damage the union nut.

Always remove the union nut and end connectors from the ball valve for installation. Make sure that you slide the union nut onto the pipe with the thread facing the proper direction BEFORE installing the end connector.

Solvent cement the pipe into the union or ball valve sockets before the union nut connections are engaged. Be careful not to get any cement on the sealing surfaces, which can disrupt the seal and cause leaks. For best results, allow the cemented joint to properly cure prior to assembling the union nut connection in order to avoid damaging the uncured joint.

Once the cement has cured, ensure that the O-ring is securely seated in its groove. The O-ring should rest securely in place without adhesive or other aids.

There should be no gap between the mating components, so the threaded nut serves only to compress the O-ring, thus creating the seal. However, a small gap, less than 1/8 in (3.2 mm), between the mating components is acceptable.

## Installing Expansion Joints

GF's expansion joint consists of two telescoping tubes designed with a triple O-ring system and is available in a variety of configurations. Expansion joints are necessary when standard expansion loops are not practical or not desired. Expansion joints allow for rigid mounting between two fixed points with the inner tube expanding and contracting like a piston against the anchored outer tube.

Thermoplastics have a high coefficient of thermal expansion. In many cases, this rate of expansion will be up to 10 times that of metals. Expansion and contraction need to be considered when designing and installing any plastic piping system. Dependent on the amount of expansion, design considerations to compensate for this pipe movement may be necessary. The stresses from an improperly designed and installed system can cause catastrophic failure or can significantly reduce the effective service life of the system.

Expansion joints are an effective means of designing for expansion or contraction and should be the preferred consideration when

1. The system has critical dimensions with no room for movement (i.e. manifold systems)
2. The system has significant space constraints
3. The system will experience frequent thermal cycling
4. The system will be exposed to a temperature change beyond 30°F (17°C), and/or
5. Physical appearance is critical

Normally expansion joints are not necessary indoors unless the temperature of the air and/or liquid is going to vary. Outdoor installations need to consider expansion and contraction. The amount of expansion is based on the temperature differential between the minimum and maximum of the air and/or liquid.

The expansion joint should be mounted so that the inner tube (piston) can travel freely in a straight line. Any misalignment may cause the expansion joint to bind. The outer tube (expansion joint barrel) should be well supported and clamped to allow all of the expansion to occur in the piston. If the expansion tube is to be used in the vertical position, the piston should be oriented in a downwards orientation so as to prevent dirt or debris from entering the O-ring seal. The alignment of expansion joints is critical to prevent binding due to the pipe being cocked. Ensure that any anticipated expansion is aligned with the expansion joint.

Cycle the piston several times prior to installation. It may be necessary to assist the piston by bumping it (or using a strap wrench for larger sizes) to begin movement if the expansion joint has been in storage for some time. Ensure the expansion joint piston has unrestricted travel. For notes on the piston position at the time of installation, see Section 3.2.3.3.

Caution: Do not test with air or air over water.

## Gasket Design

GF Harvel gasketed pipe utilizes gaskets that are locked in place at the factory as part of the manufacturing process. Two styles of factory installed gaskets are used. Pipe sizes 2" through 8" incorporate the Rieber style gasket; 10" through 24" diameter pipes utilize the Retained Ring style gasket. Both gasket styles are locked in place, and eliminate the need to install gaskets in the field. This technique also prevents fish mouthing or dislocation of the seal during assembly. The standard gasket material used for both factory-installed gasket systems is Styrene Butadiene Rubber (SBR) which offers excellent physical properties and good chemical resistance. Other gasket materials are available when necessary to meet demanding chemical resistance requirements. GF Harvel gasketed pipe offers low assembly force; flexibility to allow for variations in line pressure and changing working conditions; compensation for movement due to thermal expansion and contraction; a certain amount of allowable joint deflection; and positive, leak-free seals for both high- and low-pressure applications as well as vacuum service.

## Installation-Gasketed Pipe

Low assembly force enables fast and simple field installation without the risk of gasket dislocation. Each spigot end of GF Harvel gasket pipe contains a 15° bevel for easy insertion, as well as a factory-placed reference mark to indicate proper insertion depth. The reference marks also provide a visual means to verify proper insertion if lines are assembled above ground, and lowered into the trench after assembly. Field-cut lengths must be cut square, beveled to the same 15° taper, and marked to the proper insertion depth.



Rieber style gasket  
2" through 8"



Retained Ring style gasket  
10" through 24"

## Deflection

GF Harvel gasketed joints permit an angular deflection of 2° at the joint. Adequate deflection can usually be achieved for gentle curves by using the inherent flexibility of the pipe itself, without using joint deflection.

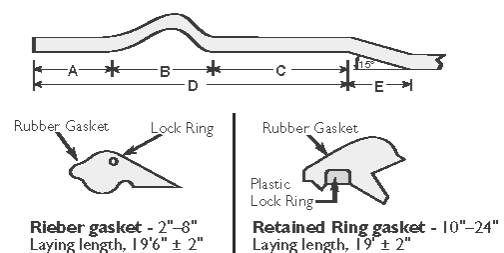



## Dimensions

IPS (in.)	A	B	C	D	E (approx.)
<b>Rieber Gasket</b>					
2	0.590	1.329	2.820	4.739	0.474
2½	0.670	1.489	2.860	5.019	0.566
3	0.708	1.587	2.940	5.235	0.688
4	0.867	1.723	3.020	5.610	0.874
6	1.063	2.076	3.200	6.339	1.274
8	1.260	2.073	3.500	6.833	1.500
<b>Retained Ring Gasket</b>					
10	1.875	2.417	4.750	9.042	1.500
12	2.000	2.619	5.500	10.119	1.500
14	2.125	3.375	6.000	11.500	1.500
16	2.250	2.875	6.500	11.625	1.500
18	2.500	3.062	7.000	12.562	1.500
20	2.750	3.375	7.375	13.500	1.500
24	2.203	3.781	8.000	13.984	1.500

### Joining Techniques-Groove Style Connections

In many installations where transition to metal pipe, or where disassembly is a prime factor, metallic grooved style couplings can be used to join PVC and CPVC pipe to alternate IPS size piping materials. In addition to the ease of disassembly, this type of connection also allows for a certain degree of angular adjustment and expansion/contraction. In order to prepare the plastic pipe for adapting the grooved style couplings, it is necessary to roll or cut a groove onto the end of the pipe removing from the wall thickness. Where shock loads from intermittent operation are probable, particularly with large diameter pipe, angular displacement should be avoided and the pipe aligned longitudinally to minimize high stress levels on the grooves. Grooved end pipe is available from GF Harvel.

Corrosion resistant grooved PVC piping in IPS sizes 2" through 24" is available as a fabrication option from the factory. Pressure rating of grooved end piping varies with schedule, pipe size, temperature, and the selected groove style coupling manufacturers' product specifications. As with all PVC piping, the maximum service temperature for grooved end PVC pipe is 140°F. The groove coupling manufacturer should be consulted for temperature and pressure limitations of the coupling used. This pipe is available from Georg Fischer Harvel LLC with grooved ends designed for use with Victaulic Style 75 or Style 77 or equivalent flexible style couplings. Only flexible style grooved couplings are recommended for use with GF Harvel grooved-end PVC pipe.

Rigid style couplings are not recommended for use on plastic pipe as they provide a compressive/shear load that can result in failure.

GF Harvel currently utilizes both the roll grooving method as well as the cut grooving method to provide grooved end pipe in the sizes below.

Only flexible style metallic grooved couplings are recommended for use with plastic pipe. Rigid style couplings can provide a compressive/ shear load to plastic pipe resulting in failure; as a result their use is not recommended. Care should be taken to investigate the compatibility of the grooved coupling gasket material for the intended application.

### Groove Style (roll or cut)

Size (in)	SCH 40	SCH 80
2	ROLL	ROLL
2½	ROLL	ROLL
3	ROLL	ROLL
4	ROLL	ROLL
6	ROLL	ROLL
8	ROLL	ROLL
10	ROLL	CUT
12	ROLL	CUT
14	CUT	CUT
16	CUT	CUT
18	CUT	CUT
20	CUT	CUT
24	CUT	CUT

## Roll Groove Specifications (IPS)

Size (in)	O.D.	A Gasket Seat +0.015, -0.030	B Groove Width +0.030, -0.015	C Groove Diameter Actual/Tolerance	D Nominal Groove Depth	T Min. Allowable Pipe Wall
2	2.375	0.625	0.344	2.250 +0.000, -0.015	0.063	0.065
2½	2.875	0.625	0.344	2.720 +0.000, -0.015	0.078	0.083
3	3.500	0.625	0.344	3.344 +0.000, -0.015	0.078	0.083
4	4.500	0.625	0.344	4.334 +0.000, -0.015	0.083	0.083
6	6.625	0.625	0.344	6.455 +0.000, -0.015	0.085	0.109
8	8.625	0.750	0.469	8.441 +0.000, -0.020	0.092	0.109
10	10.750	0.750	0.469	10.562 +0.000, -0.025	0.094	0.134
12	12.750	0.750	0.469	12.531 +0.000, -0.025	0.109	0.156

## Cut Groove Specifications (IPS)

Size (in)	O.D.	A Gasket Seat	B Groove Width	C Groove Diameter	D Nominal Groove Depth	T Min. Allowable Pipe Wall
2	2.375	0.625	0.313	2.25	0.063	0.154
2½	2.875	0.625	0.313	2.72	0.078	0.188
3	3.5	0.625	0.313	3.344	0.078	0.188
4	4.5	0.625	0.375	4.334	0.083	0.203
6	6.625	0.625	0.375	6.455	0.085	0.219
8	8.625	0.75	0.438	8.441	0.092	0.238
10	10.75	0.75	0.5	10.562	0.094	0.25
12	12.75	0.75	0.5	12.531	0.109	0.279
14	14	0.938	0.5	13.781	0.109	0.281
16	16	0.938	0.5	15.781	0.109	0.312
18	18	1	0.5	17.781	0.109	0.312
20	20	1	0.5	19.781	0.109	0.312
24	24	1	0.563	23.656	0.172	0.375

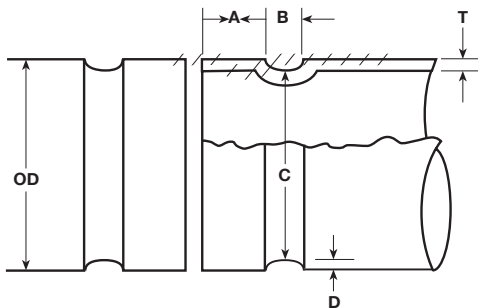

**NOTE** Temperature and Pressure ratings and limitations are dependant on the grooved coupling manufacturer's specifications.

**NOTE** A gasket/joint lubricant is recommended to prevent pinching the gasket and to assist the seating and alignment processes during assembly of grooved couplings. Certain lubricants may contain a petroleum base or other chemicals, which will cause damage to the plastic pipe, gasket and adapter. Georg Fischer Harvel LLC suggests verifying the suitability for use of the selected lubricant with the lubricant manufacturer prior to use.

## Support Installation

When thermoplastic piping systems are installed above ground, they must be properly supported to avoid unnecessary stresses and possible sagging. Horizontal runs require the use of hangers as described in Figure 4-10, spaced approximately as indicated in Table 4-14 and Table 4-15. Note that additional support is required as temperatures increase. Continuous support can be accomplished by the use of smooth structural angles or channels. Where the pipe is exposed to impact damage, protective shields should be installed.

Support spacing is a function of

1. Pipe size
2. Operating temperature
3. Location of heavy valves or fittings
4. Mechanical properties of the piping
5. Specific gravity of water 1g/cm<sup>3</sup>

The supports should be close enough to maintain pipe alignment, prevent sagging, prevent grade reversal, and support changes in directions. Concentrated loads such as valves, heavy fittings and components, etc. should be supported directly when possible and as closely as possible otherwise. When dealing with expansion and contraction, supports should not restrict axial movement. File smooth any sharp edges or burrs in all supports. Plastic piping should not be placed near heated surfaces or open flame.

**Table 4-14: Industrial PVC support spacing (in feet)**

Size (inch)	Schedule 40					Schedule 80					Schedule 120				
	60°F	80°F	100°F	120°F	140°F	60°F	80°F	100°F	120°F	140°F	60°F	80°F	100°F	120°F	140°F
¼	4.0	3.5	3.5	2.0	2.0	4.0	4.0	3.5	2.5	2.0	-	-	-	-	-
⅜	4.0	4.0	3.5	2.5	2.0	4.5	4.5	4.0	2.5	2.5	-	-	-	-	-
½	4.5	4.5	4.0	2.5	2.5	5.0	4.5	4.5	3.0	2.5	5.0	5.0	4.5	3.0	2.5
¾	5.0	4.5	4.0	2.5	2.5	5.5	5.0	4.5	3.0	2.5	5.5	5.0	4.5	3.0	3.0
1	5.5	5.0	4.5	3.0	2.5	6.0	5.5	5.0	3.5	3.0	6.0	5.5	5.0	3.5	3.0
1¼	5.5	5.5	5.0	3.0	3.0	6.0	6.0	5.5	3.5	3.0	6.5	6.0	5.5	3.5	3.5
1½	6.0	5.5	5.0	3.5	3.0	6.5	6.0	5.5	3.5	3.5	6.5	6.5	6.0	4.0	3.5
2	6.0	5.5	5.0	3.5	3.0	7.0	6.5	6.0	4.0	3.5	7.5	7.0	6.5	4.0	3.5
2½	7.0	6.5	6.0	4.0	3.5	7.5	7.5	6.5	4.5	4.0	8.0	7.5	7.0	4.5	4.0
3	7.0	7.0	6.0	4.0	3.5	8.0	7.5	7.0	4.5	4.0	8.5	8.0	7.5	5.0	4.5
3½	7.5	7.0	6.5	4.0	4.0	8.5	8.0	7.5	5.0	4.5	9.0	8.5	7.5	5.0	4.5
4	7.5	7.0	6.5	4.5	4.0	9.0	8.5	7.5	5.0	4.5	9.5	9.0	8.5	5.5	5.0
5	8.0	7.5	7.0	4.5	4.0	9.5	9.0	8.0	5.5	5.0	10.5	10.0	9.0	6.0	5.5
6	8.5	8.0	7.5	5.0	4.5	10.0	9.5	9.0	6.0	5.0	11.5	10.5	9.5	6.5	6.0
8	9.0	8.5	8.0	5.0	4.5	11.0	10.5	9.5	6.5	5.5	12.0	11.5	10.0	7.0	6.5
10	10.0	9.0	8.5	5.5	5.0	12.0	11.0	10.0	7.0	6.0	-	-	-	-	-
12	11.5	10.5	9.5	6.5	5.5	13.0	12.0	10.5	7.5	6.5	-	-	-	-	-
14	12.0	11.0	10.0	7.0	6.0	13.5	13.0	11.0	8.0	7.0	-	-	-	-	-
16	12.5	11.5	10.5	7.5	6.5	14.0	13.5	11.5	8.5	7.5	-	-	-	-	-
18	13.0	12.0	11.0	8.0	7.0	14.5	14.0	12.0	11.0	9.0	-	-	-	-	-
20	14.0	12.5	11.5	10.0	8.5	15.0	14.5	12.5	11.5	9.5	-	-	-	-	-
24	15.0	13.0	12.5	11.0	9.5	17.0	15.0	14.0	12.5	10.5	-	-	-	-	-

**Table 4-14: Industrial PVC support spacing (in meters)**

Size (inch)	Schedule 40					Schedule 80					Schedule 120				
	16°C	27°C	38°C	49°C	60°C	16°C	27°C	38°C	49°C	60°C	16°C	27°C	38°C	49°C	60°C
¼	1.22	1.07	1.07	0.61	0.61	1.22	1.22	1.07	0.76	0.61	-	-	-	-	-
⅜	1.22	1.22	1.07	0.76	0.61	1.37	1.37	1.22	0.76	0.76	-	-	-	-	-
½	1.37	1.37	1.22	0.76	0.76	1.52	1.37	1.37	0.91	0.76	1.52	1.52	1.37	0.91	0.76
¾	1.52	1.37	1.22	0.76	0.76	1.68	1.52	1.37	0.91	0.76	1.68	1.52	1.37	0.91	0.91
1	1.68	1.52	1.37	0.91	0.76	1.83	1.68	1.52	1.07	0.91	1.83	1.68	1.52	1.07	0.91
1¼	1.68	1.68	1.52	0.91	0.91	1.83	1.83	1.68	1.07	0.91	1.98	1.83	1.68	1.07	1.07
1½	1.83	1.68	1.52	1.07	0.91	1.98	1.83	1.68	1.07	1.07	1.98	1.98	1.83	1.22	1.07
2	1.83	1.68	1.52	1.07	0.91	2.13	1.98	1.83	1.22	1.07	2.29	2.13	1.98	1.22	1.07
2½	2.13	1.98	1.83	1.22	1.07	2.29	2.29	1.98	1.37	1.22	2.44	2.29	2.13	1.37	1.22
3	2.13	2.13	1.83	1.22	1.07	2.44	2.29	2.13	1.37	1.22	2.59	2.44	2.29	1.52	1.37
3½	2.29	2.13	1.98	1.22	1.22	2.59	2.44	2.29	1.52	1.37	2.74	2.59	2.29	1.52	1.37
4	2.29	2.13	1.98	1.37	1.22	2.74	2.59	2.29	1.52	1.37	2.90	2.74	2.59	1.68	1.52
5	2.44	2.29	2.13	1.37	1.22	2.90	2.74	2.44	1.68	1.52	3.20	3.05	2.74	1.83	1.68
6	2.59	2.44	2.29	1.52	1.37	3.05	2.90	2.74	1.83	1.52	3.51	3.20	2.90	1.98	1.83
8	2.74	2.59	2.44	1.52	1.37	3.35	3.20	2.90	1.98	1.68	3.66	3.51	3.05	2.13	1.98
10	3.05	2.74	2.59	1.68	1.52	3.66	3.35	3.05	2.13	1.83	-	-	-	-	-
12	3.51	3.20	2.90	1.98	1.68	3.96	3.66	3.20	2.29	1.98	-	-	-	-	-
14	3.66	3.35	3.05	2.13	1.83	4.11	3.96	3.35	2.44	2.13	-	-	-	-	-
16	3.81	3.51	3.20	2.29	1.98	4.27	4.11	3.51	2.59	2.29	-	-	-	-	-
18	3.96	3.66	3.35	2.44	2.13	4.42	4.27	3.66	3.35	2.74	-	-	-	-	-
20	4.27	3.81	3.51	3.05	2.59	4.57	4.42	3.81	3.51	2.90	-	-	-	-	-
24	4.57	3.96	3.81	3.35	2.90	5.18	4.57	4.27	3.81	3.20	-	-	-	-	-

**Table 4-15: Industrial CPVC support spacing (in feet)**

Size (inch)	Schedule 40						Schedule 80					
	73°F	100°F	120°F	140°F	160°F	180°F	73°F	100°F	120°F	140°F	160°F	180°F
1/2	5.0	4.5	4.5	4.0	2.5	2.5	5.5	5.0	4.5	4.5	3.0	2.5
3/4	5.0	5.0	4.5	4.0	2.5	2.5	5.5	5.5	5.0	4.5	3.0	2.5
1	5.5	5.5	5.0	4.5	3.0	2.5	6.0	6.0	5.5	5.0	3.5	3.0
1 1/4	5.5	5.5	5.5	5.0	3.0	3.0	6.5	6.0	6.0	5.5	3.5	3.0
1 1/2	6.0	6.0	5.5	5.0	3.5	3.0	7.0	6.5	6.0	5.5	3.5	3.5
2	6.0	6.0	5.5	5.0	3.5	3.0	7.0	7.0	6.5	6.0	4.0	3.5
2 1/2	7.0	7.0	6.5	6.0	4.0	3.5	8.0	7.5	7.5	6.5	4.5	4.0
3	7.0	7.0	7.0	6.0	4.0	3.5	8.0	8.0	7.5	7.0	4.5	4.0
3 1/2	7.5	7.5	7.0	6.5	4.0	4.0	8.5	8.5	8.0	7.5	5.0	4.5
4	7.5	7.5	7.0	6.5	4.5	4.0	9.0	8.5	8.5	7.5	5.0	4.5
5	8.5	8.0	7.5	7.0	5.0	4.5	10.0	9.5	9.0	8.0	5.5	5.0
6	8.5	8.0	7.5	7.0	5.0	4.5	10.0	9.5	9.0	8.0	5.5	5.0
8	9.5	9.0	8.5	7.5	5.5	5.0	11.0	10.5	10.0	9.0	6.0	5.5
10	10.5	10.0	9.5	8.0	6.0	5.5	11.5	11.0	10.5	9.5	6.5	6.0
12	11.5	10.5	10.0	8.5	6.5	6.0	12.5	12.0	11.5	10.5	7.5	6.5
14	12.0	11.0	10.0	9.0	8.0	6.0	15.0	13.5	12.5	11.0	9.5	8.0
16	13.0	12.0	11.0	9.5	8.5	7.0	16.0	15.0	13.5	12.0	10.0	8.5
18	13.0	12.5	11.0	10.0	9.0	7.5	16.0	15.5	14.0	12.5	10.5	9.0
20	14.0	13.0	11.5	10.5	9.0	7.5	17.0	16.0	14.5	13.0	11.0	9.5
24	15.0	14.0	12.5	11.0	9.5	8.0	17.5	16.5	15.0	13.5	11.5	10.0

**Table 4-16: Industrial CPVC support spacing (in meters)**

Size (inch)	Schedule 40						Schedule 80					
	23°F	38°C	49°C	60°C	71°C	82°C	23°F	38°C	49°C	60°C	71°C	82°C
1/2	1.52	1.37	1.37	1.22	0.76	0.76	1.68	1.52	1.37	1.37	0.91	0.76
3/4	1.52	1.52	1.37	1.22	0.76	0.76	1.68	1.68	1.52	1.37	0.91	0.76
1	1.68	1.68	1.52	1.37	0.91	0.76	1.83	1.83	1.68	1.52	1.07	0.91
1 1/4	1.68	1.68	1.68	1.52	0.91	0.91	1.98	1.83	1.83	1.68	1.07	0.91
1 1/2	1.83	1.83	1.68	1.52	1.07	0.91	2.13	1.98	1.83	1.68	1.07	1.07
2	1.83	1.83	1.68	1.52	1.07	0.91	2.13	2.13	1.98	1.83	1.22	1.07
2 1/2	2.13	2.13	1.98	1.83	1.22	1.07	2.44	2.29	2.29	1.98	1.37	1.22
3	2.13	2.13	2.13	1.83	1.22	1.07	2.44	2.44	2.29	2.13	1.37	1.22
3 1/2	2.29	2.29	2.13	1.98	1.22	1.22	2.59	2.59	2.44	2.29	1.52	1.37
4	2.29	2.29	2.13	1.98	1.37	1.22	2.74	2.59	2.59	2.29	1.52	1.37
5	2.59	2.44	2.29	2.13	1.52	1.37	3.05	2.90	2.74	2.44	1.68	1.52
6	2.59	2.44	2.29	2.13	1.52	1.37	3.05	2.90	2.74	2.44	1.68	1.52
8	2.90	2.74	2.59	2.29	1.68	1.52	3.35	3.20	3.05	2.74	1.83	1.68
10	3.20	3.05	2.90	2.44	1.83	1.68	3.51	3.35	3.20	2.90	1.98	1.83
12	3.51	3.20	3.05	2.59	1.98	1.83	3.81	3.66	3.51	3.20	2.29	1.98
14	3.66	3.35	3.05	2.74	2.44	1.83	4.57	4.11	3.81	3.35	2.90	2.44
16	3.96	3.66	3.35	2.90	2.59	2.13	4.88	4.57	4.11	3.66	3.05	2.59
18	3.96	3.81	3.35	3.05	2.74	2.29	4.88	4.72	4.27	3.81	3.20	2.74
20	4.27	3.96	3.51	3.20	2.74	2.29	5.18	4.88	4.42	3.96	3.35	2.90
24	4.57	4.27	3.81	3.35	2.90	2.44	5.33	5.03	4.57	4.11	3.51	3.05

**Note: Common practice is to install suitable hangers within 2 ft (0.6 m) of each side of a pipe joint; changes in direction should be supported as close as possible to the fitting to reduce tensional stress without restricting movement. Heavy system components such as valves, flanged assemblies, tees, and other forms of concentrated stress loads must be independently supported. In addition, valves should be braced adequately to prevent movement and stress loads as the**

## Pipe Bracket Support Centers and Fixation of Plastic Pipelines

### General Pipe Supports and Brackets

Pipelines need to be supported at specific intervals, depending upon the material, the average pipe wall temperature, the specific gravity of the medium, and the diameter and wall thickness of the pipe. The determination of the pipe support centers has been based on the permissible amount of deflection of the pipe between two brackets. The pipe bracket centers given on the next page are calculated on the basis of a permissible deflection of max. 0.25 cm (0.01 inch) between two brackets.

### Pipe Bracket Spacing in the Case of Fluids with Specific Gravity $\leq 1.0$ (62.4 Lb/Ft<sup>3</sup>)

Where fluids with a specific gravity exceeding 1g/cm<sup>3</sup> are to be conveyed, pipe spacing can be adjusted by dividing the support spacing by the specific gravity.

### Installation of Closely Spaced Pipe Brackets

A continuous support may be more advantageous and economical than pipe brackets for small diameter horizontal pipe work, especially in a higher temperature range. Installation in a "V"-or "U"-shaped support made of metal or heat-resistant plastic material has proven satisfactory.

### Pipe Bracket Requirements

When mounted, the inside diameter of the bracket must be greater than the outside diameter of the pipe, in order to allow length changes of the pipe at the specified points. The inside edges of the pipe bracket must be formed in such a way that no damage to the pipe surface is possible. GF pipe brackets meet these requirements. They are made of plastic and may be used under rugged working conditions and also in areas where the pipe work is subjected to the external influence of aggressive atmospheres or media. GF pipe brackets are suitable for PVC, CPVC, PE, PP, and PVDF pipes.

GF has developed the Stress Less Pipe Guides product line, the first such clamps especially designed to eliminate stress transfer to pipe due to thermal expansion or seismic events. They have an engineered, designed gap of 3mm between the clamp insert and pipe OD. Excessive force can never be exerted on the pipe regardless of tightening of bolts by the installer.

### Arrangement of Fixed Brackets

Fixed point should not be a compressive force to hold the pipe, but a design anchor that withstands the axial load. If the pipe bracket is positioned directly beside a fitting, the length change of the pipeline is limited to one direction only (one-sided fixed point).

If it is, as in most cases, necessary to control the length change of the pipeline in both directions, the pipe bracket must be positioned between two fittings. The pipe bracket must be robust and firmly mounted in order to take up the force arising from the length change in the pipeline. Hanger type brackets are not suitable as fixed points..

## Vertical Supports

Vertical lines must also be supported at intervals so that the fittings at the lower end of a riser or column are not overloaded. The supports should not exert a compressive strain on the pipe such as riser-type clamps that squeeze the pipe. Hangers and clamps suitable for this purpose include riser clamps or double bolt type clamps installed in such a manner that will allow for movement of the pipe due to thermal expansion and contraction (i.e. floating system). Clamps and hangers used must not compress, distort, cut, or abrade the piping. Clamps used must not exert compressive stresses on the pipe; the use of riser clamps that utilize compression to support the pipe weight are not recommended.

If possible, the riser clamps should be located just below a fitting so that the shoulder of the fitting rests against the clamp to support the weight of the vertical column. Horizontal take-offs from the riser should be independently supported and located as close to the riser clamp as possible. Offset configurations utilizing at least one change in direction should be used to tie horizontal runs into the riser in close proximity to the riser clamp. Offset configurations used between the riser tee and the wall entry will minimize stress on the horizontal connection should movement of the riser occur. The use of a single horizontal run from the riser tee through the wall should not be used on systems conveying fluids at elevated temperatures.

Compared to horizontal runs, the effects of thermal expansion on fluid filled, vertical risers is typically minimized due to the weight of the fluid column in combination with the restraint provided at horizontal take-offs. The rate of thermal expansion must be calculated based on the temperature change anticipated. Vertical piping should be maintained in straight alignment with supports at proper intervals plus a mid-story guide, as specified by the design engineer, to allow for movement caused by thermal expansion and contraction of the piping. Mid-story guides should always be used on small diameter pipe (less than 2 in diameter), particularly on hot water lines, to minimize deflection caused by thermal expansion. The guidelines provided herein for vertical risers do not apply to horizontal runs. For horizontal runs, the use of expansion loops, offsets, bends, and other means are recommended to compensate for movement due to changes in temperature.

### Vertical Riser Support When Riser Clamps can't be Installed

For vertical risers requiring support where horizontal take-offs may not be present, one common approach is to install clamps just below a modified coupling so that the shoulder of the coupling rests on the clamp. Fittings can be modified in the field to achieve this by cutting a coupling in two, just above the stop at the socket bottom, and then cutting this piece in half lengthwise to provide two halves which do not contain the stop. The two halves are then solvent cemented to the pipe at the proper location so that the shoulder of the modified coupling rests on the clamp once the joint is allowed to cure properly. See Figure 4-11 for details.



Note: A modified coupling must only be used to provide support to the riser and must not be used to join two pieces of pipe. The load bearing strength of a modified coupling used for riser support is directly related to the surface area of the coupling and the integrity of the solvent weld.

Figure 4-11: Modified coupling installation

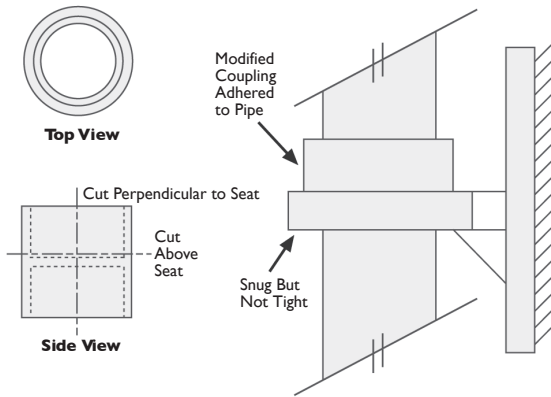

**Anchors and Guides**

Anchors in a piping system direct movement of pipe within a defined reference frame. At the anchoring point, there is no axial or transverse movement. Guides are used to allow axial movement of pipe but prevent transverse movement. Anchoring and guides should be engineered to provide the required function without point loading the plastic pipe. Guides and anchors are used whenever expansion joints are used, on long runs, and on directional changes in piping.

Figure 4-12: Continuous support arrangements

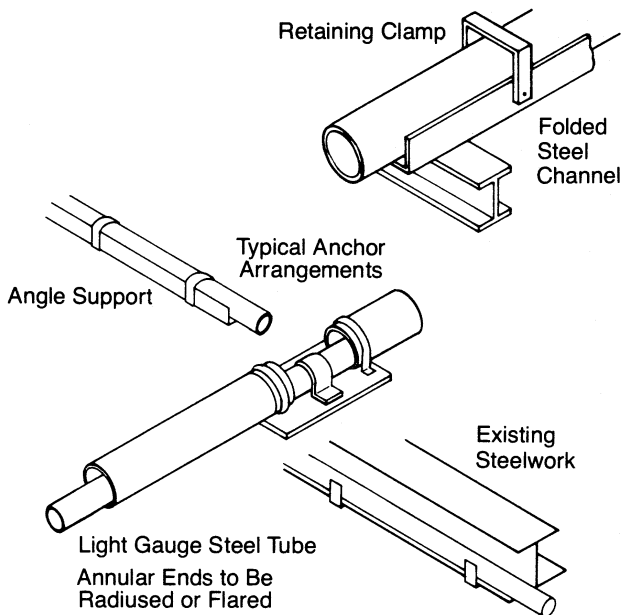

Figure 4-13: Typical support arrangements

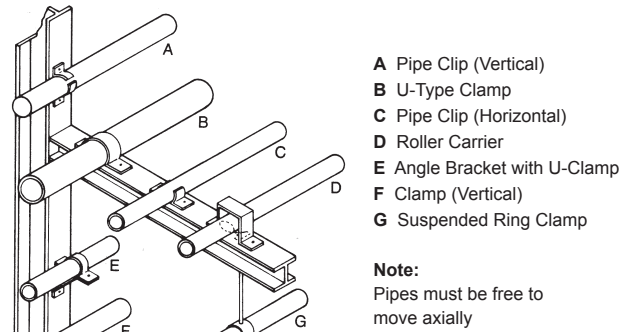

Figure 4-14: Guides and anchors examples

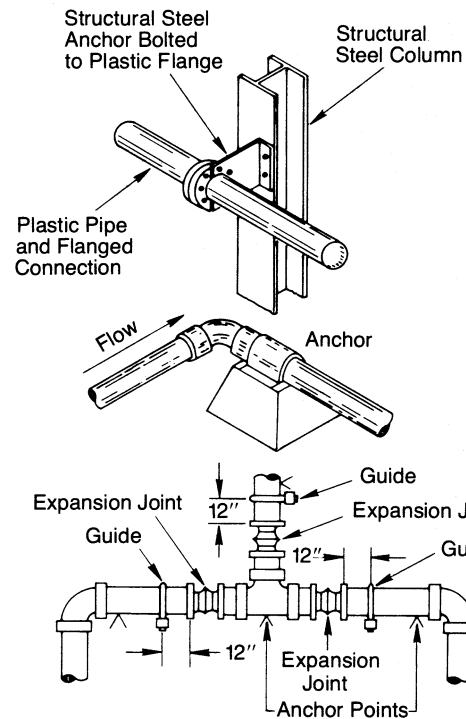
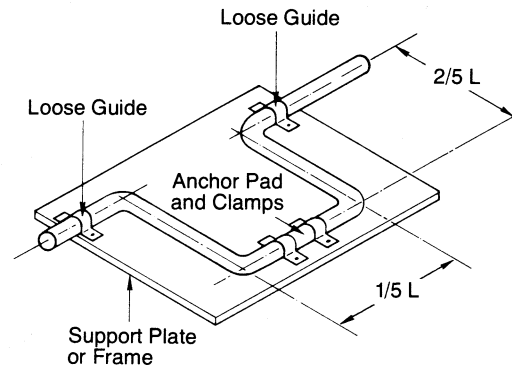
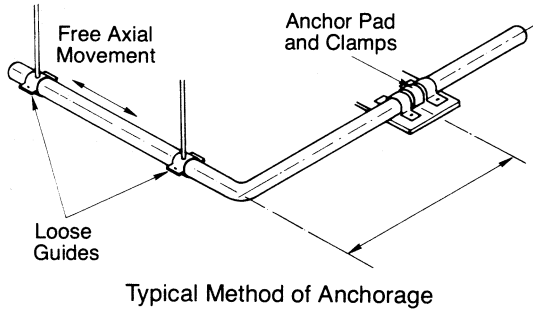

Figure 4-15: A typical method of anchorage of a change in direction



**Figure 4 16: Typical method of anchorage**



### Underground Installation

Underground piping must be installed in accordance with any applicable regulations, ordinances, and codes. Since piping is installed in a wide range of sub-soils, attention should be given to local pipe laying techniques which may provide a solution to a particular pipe bedding issue. The follow information is applicable to PVC and CPVC piping joined via the solvent cementing method and may be considered as a general guide.

### Storage, Handling, and Inspection

Thermoplastic pipe must not be exposed to elevated temperatures during shipping and/or storage. Exposure to excessive temperatures will result in distortion/deformation of the pipe. PVC and CPVC pipe should not be dropped, have objects dropped on them, nor be subjected to external loads. Thermoplastics can be damaged by abrasion and gouging. Pipe must not be dragged across the ground or over obstacles. Impacts such as dropping from sizable heights and rough handling should be avoided, particularly in cold weather. The product shall be inspected for any scratches, splits or gouges that may have occurred from improper handling or storage. If found, these sections must be cut out and discarded.

Before installation, PVC and CPVC piping products should be thoroughly inspected for cuts, scratches, gouges, or split ends which may have occurred to the products during shipping and handling. Do not use damaged sections. Damaged sections found must be cut out and discarded.

### Trench Construction

For buried, non-pressure applications, trench construction, bedding, haunching, initial backfill, compaction, and final backfill shall be conducted as required by the project engineer or by following ASTM D2321 Standard Practice for Underground Installation of Thermoplastic Pipe for Sewers and Other Gravity-Flow Applications. For pressure applications, ASTM D2774 Standard Practice for Underground Installation of Thermoplastic Pressure Piping shall be followed in conjunction with this information when details are not provided by the project engineer.

The trench should be of adequate width to allow convenient installation, while also be as narrow as possible. Minimum trench widths may be utilized by joining pipe outside the

trench and lowering it into the trench after adequate joint strength has been achieved. Trench widths will have to be wider where pipe is joined in the trench or where thermal expansion and contraction is a factor.

Refer to Page 55 for recommended installation techniques and set and cure times for solvent cemented joints. Do not lower into the trench until adequate joint strength is achieved.

Trench depth is determined by intended service and local conditions. Pipe for conveying liquids susceptible to freezing should be buried no less than 12 in (30 cm) below the maximum frost level. Permanent lines subjected to heavy traffic should have a minimum cover of 24 in (61 cm). For light traffic 12 in (30 cm) to 18 in (46 cm) is normally sufficient for small diameter pipe (typically less than 3 in diameter). With larger sizes, bearing stresses should be calculated to determine cover required. Reliability and safety should always be considered, as well as local, state, and national codes.

**Note: Water filled pipe should be buried at least 12 in (30 cm) below the maximum expected frost line.**

It is recommended that thermoplastic piping be run within a metal or concrete casing when it is installed beneath surfaces that are subject to heavy weight or constant traffic such as roadways and railroad tracks. Piping systems must be designed and installed to ensure they can handle anticipated loads. Refer to Page 12 & 13 for additional information on collapse pressures.

The trench bottom should be continuous, relatively smooth, and free of rocks. Where ledge rock, hardpan, or boulders are encountered, it is necessary to pad the trench bottom using a minimum of 4 in (10 cm) of tamped earth or sand beneath the pipe as a cushion and for protection of the pipe from damage.

Sufficient cover must be maintained to keep external stress levels below acceptable design stresses. Reliability and safety of service is of major importance in determining minimum cover. Local, state, and national codes may also govern.

### Snaking of Pipe

For small diameter piping systems (typically less than 3 in diameter), snaking of pipe is particularly important to compensate for thermal expansion and contraction of the piping when installing pipe in hot weather. This may also apply to larger diameter piping under specific applications and site conditions. After the pipe has been solvent welded and allowed to set properly, it is advisable to snake the pipe according to the following recommendations beside the trench during its required drying time (cure time).

**Note: Be especially careful not to apply any stress that will disturb the undried joint.**

This snaking is necessary in order to allow for any anticipated thermal contraction that will take place in the newly joined pipeline. Refer to Page 23 for more information on thermal expansion/contraction.

Snaking is particularly necessary on the lengths that have been solvent welded during the late afternoon or a hot summer day, because their drying time will extend through the cool of the night when thermal contraction of the pipe could stress the joints to the point of pull out. This snaking is also especially necessary with pipe that is laid in its trench (necessitating wider trenches than recommended) and is backfilled with cool earth before the joints are thoroughly dry. See Figure 4-17 and Table 4-16 for information regarding loop lengths and loop offsets.

**Figure 4-17: Loop offset in inches for contraction for pipe diameters of less than 3 in.**

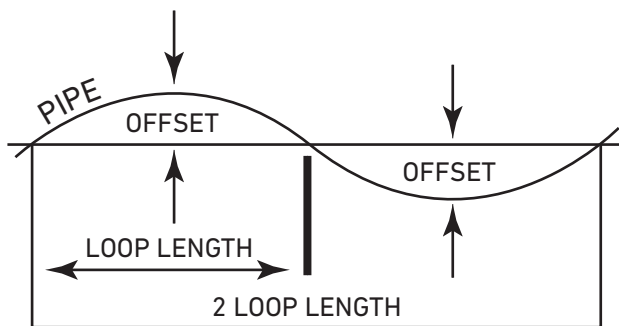

**Table 4-16: Loop offset in relation to loop length and maximum temperature variation between solvent welding and final use**

Loop Offset (in)	Maximum Temperature Variation Between Solvent Welding and Final Use (°F)									
Length (ft)	10°	20°	30°	40°	50°	60°	70°	80°	90°	100°
20	3	4	5	5	6	6	7	7	8	8
50	7	9	11	13	14	16	17	18	19	20
100	13	18	22	26	29	32	35	37	40	42

Loop Offset (cm)	Maximum Temperature Variation Between Solvent Welding and Final Use (°C)									
Length (m)	6°	11°	17°	22°	28°	33°	39°	44°	50°	56°
6	3	4	5	5	6	6	7	7	8	8
15	7	9	11	13	14	16	17	18	19	20
30	13	18	22	26	29	32	35	37	40	42

**Note: Expansion and contraction could become excessive in systems operating at near or at the maximum allowable temperature ranges with intermittent flow and buried lines.**

In the above noted cases, the lines should not be snaked. The use of properly installed expansion joints installed within suitable concrete pits is recommended for PVC and CPVC systems operating at or near upper temperature limits. A section of larger diameter PVC pipe or other suitable sleeve should be used over the carrier pipe to pass through the wall of the concrete. This will minimize the potential for damage (scratching and scarring) to the carrier pipe as the result of movement caused by thermal expansion/contraction.

Expansion joints should be suitably anchored independently of the carrier line. Axial guides should be used to direct movement into the expansion joint.

### Bedding and Haunching

The pipe must be uniformly and continuously supported over its entire length on firm, stable material. Proper bedding and haunching materials are dependent on local soil conditions and type. Follow classes of embedment and backfill materials called-out in ASTM D2321.

The trench bottom should be continuous, relatively smooth, and free of rocks. Where ledge rock, hardpan, or boulders are encountered, it is necessary to pad the trench bottom with proper bedding using a minimum of 6 in (15 cm) of suitable bedding beneath the pipe as a cushion and to protect the pipe from damage.

For belled end pipe, provide bell holes in bedding no larger than necessary to ensure uniform pipe support.

**Note: Use of threaded connections should be avoided in underground applications.**

Where a transition to alternate materials is required, the use of a flange component with a suitable gasket is recommended. At vertical transitions from below ground systems to connections above ground, follow above ground installation procedures with regard to compensating for thermal expansion/contraction, weatherability, and proper support recommendations. Valves and other concentrated weight loads should be independently supported. Avoid excessive bending of pipe; excessive deflection of pipe and joints can reduce pressure bearing capability and cause failure.

Embedment materials (initial back-fill) shall be placed by methods that will not disturb or damage the pipe. The haunching material placed in the area between the bedding and the underside of the pipe shall be worked-in and hand tamped prior to placing and compacting the remainder of the embedment material in the pipe zone. Install and compact bedding materials in a maximum of 6 in (15 cm) thick layers within the pipe zone. Refer to Figure 4-18 and Figure 4-19 for clarification. Compaction techniques and equipment used must not contact or damage the pipe.

**Figure 4-18: Illustration of bedding, haunching, and backfill layers**

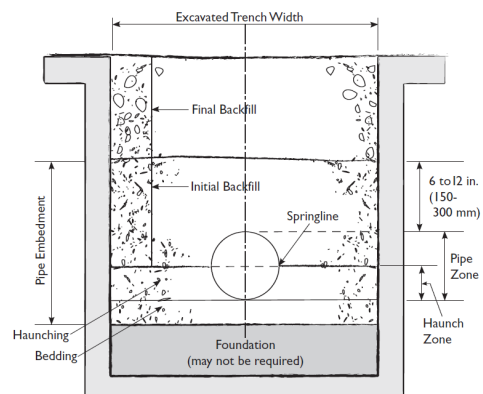
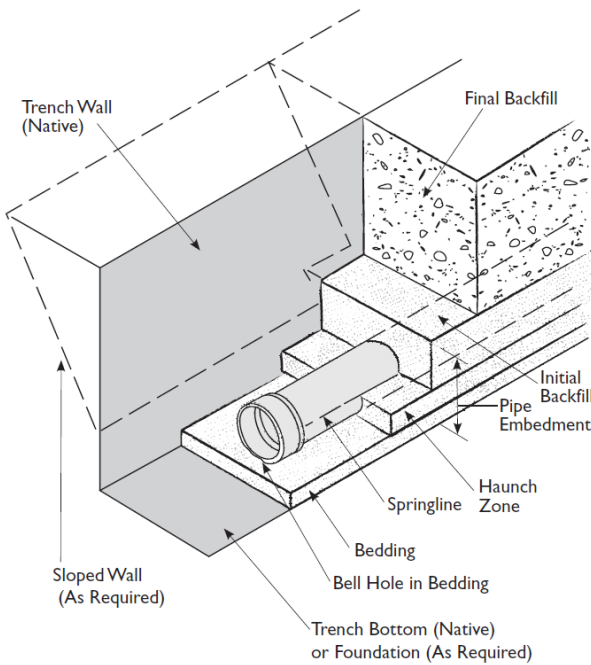

Figure 4-19: Illustration of fill layers in trench



### Backfilling

Where possible, underground pipe should be thoroughly inspected and tested for leaks prior to backfilling. The pipe should be uniformly and continuously supported over its entire length on firm, stable material. Blocking should not be used to change pipe grade or to intermittently support pipe across excavated sections. Pipe is installed in a wide range of sub-soils. These soils should not only be stable, but applied in such a manner so as to physically shield the pipe from damage. Attention should be given to local pipe laying experience that may indicate particular pipe bedding problems. Initial backfill materials free of rocks, with particle sizes  $\frac{1}{2}$  in (13 mm) or less, should be used to surround the pipe and should be placed and compacted in layers. Each layer should be sufficiently compacted to uniformly develop lateral passive soil forces during the backfill operations. It may be advisable to have the pipe under water pressure, 15 to 25 psi (1.0 to 1.7 bar), during backfilling. Final backfill should be placed and spread in uniform layers in such a manner to fill the trench completely so there will be no unfilled spaces under or about rocks or lumps of earth in the backfill. Large or sharp rocks, frozen clods, and other debris greater than 3 in (8 cm) diameter should be removed.

Sufficient cover must be maintained to keep external stress levels below acceptable design stresses. Reliability and safety of service is of major importance in determining minimum cover. Rolling equipment or heavy tampers should only be used to consolidate the final backfill. Attention should be given to local pipe laying experience that may indicate particular pipe bedding problems. Local, state, and national codes may also govern.

### Cold Temperature Installation

PVC and CPVC are rigid thermoplastic materials. As such, pipe stiffness increases and impact resistance decreases in colder temperature environments. PVC and CPVC can become more susceptible to physical damage when exposed to cold temperatures. Following the guidelines below will minimize the potential for damage. Impact resistance and ductility decrease at colder temperatures. In addition, a drop in temperature will cause the piping to contract, which must be addressed with proper system design. Due to PVC and CPVC's coefficient of thermal expansion, a 20 ft (6 m) length of pipe will contract approximately  $\frac{3}{4}$  in (19 mm) and  $\frac{7}{8}$  in (22 mm), respectively, when cooled from 95°F (35°C) to -5°F (-21°C). Since pressure bearing capacity is not reduced with a decrease in temperature, PVC and CPVC piping are suitable for use at colder temperatures provided the fluid medium is protected from freezing, consideration is given to the effects of expansion and contraction, and additional care and attention are given during handling, installation, and operation of the system to prevent physical damage caused by impact or other mechanical forces.

### Depth of Burial

When installed underground an external load is placed on a thermoplastic pipe; its diameter will begin to deflect, meaning its sides will move outward and slightly downward. If GF Piping Systems pipe is buried in supportive soil, the stiffness of the soil will help support the pipe. This action and reaction is the key to how a pipe carries external loads while buried.

The support from the embedded soil and the pipe stiffness form a combination to resist deflection from external loads. Thermoplastic pipe's resistance to deflection in an unburied state is measured by its pipe stiffness. Due to the excellent quality of GF Piping Systems thermoplastic piping, it has a high pipe stiffness value. In general, the greater the pipe stiffness values, the higher the load capacity. Table 4-17 contains values of pipe stiffness for your reference.

**Table 4-17: Pipe stiffness for Industrial PVC**

<b>Pipe Stiffness (PS) Values (lb/in<sup>2</sup>)</b>			
<b>Nominal OD (in)</b>	<b>Schedule 40</b>	<b>Schedule 80</b>	<b>Schedule 120</b>
1/8	15424	54031	-
1/4	13854	42399	-
3/8	7103	22696	-
1/2	6224	17919	30668
3/4	3293	9532	13535
1	2675	7345	10835
1 1/4	1467	4127	6184
1 1/2	1059	3057	4551
2	626	1938	3057
2 1/2	823	2248	2969
3	534	1547	2575
3 1/2	403	1209	-
4	323	996	2336
5	216	709	-
6	161	637	1495
8	110	438	1406
10	82	374	-
12	67	347	-
14	63	340	-
16	63	323	-
18	63	311	-
20	54	301	-
24	48	287	-

**Table 4-17 (continued): Pipe stiffness for Industrial PVC**

<b>Pipe Stiffness (PS) Values (MPa)</b>			
<b>Nominal OD (in)</b>	<b>Schedule 40</b>	<b>Schedule 80</b>	<b>Schedule 120</b>
1/8	106.34	372.53	-
1/4	95.52	292.33	-
3/8	48.97	156.48	-
1/2	42.91	123.55	211.45
3/4	22.70	65.72	93.32
1	18.44	50.64	74.70
1 1/4	10.11	28.45	42.64
1 1/2	7.30	21.08	31.38
2	4.32	13.36	21.08
2 1/2	5.67	15.50	20.47
3	3.68	10.67	17.75
3 1/2	2.78	8.34	-
4	2.23	6.87	16.11
5	1.49	4.89	-
6	1.11	4.39	10.31
8	0.76	3.02	9.69
10	0.57	2.58	-
12	0.46	2.39	-
14	0.43	2.34	-
16	0.43	2.23	-
18	0.43	2.14	-
20	0.37	2.08	-
24	0.33	1.98	-

Due to the ability of GF thermoplastics to flex before they break, a limit is placed on pipe diametric deflection. This limit is expressed in terms of percentage reduction in diameter due to external loading. The maximum allowable diametric deflection for GF Piping Systems PVC and CPVC piping is 5%. Any deflection greater than 5% could lead to the failure of a piping system.

One method that is commonly used to estimate pipe deflection based on its burial depth is the Modified Iowa Equation, shown in Equation (4-1). A simplified version of the equation is presented below where 5% deflection is the limiting factor. Table 4-18 through Table 4-20 give reference values of Prism Load Soil Pressures, Live Load, and Modulus of Soil Reaction factors for use in the below equation.

**Equation (4-1) - Imperial and Metric**

$$y = \frac{10 (P + L)}{0.149 (PS) + 0.061 E'}$$

Where:

- y = Percent deflection of the buried pipe's outside diameter - % (5% is the maximum allowable deflection per ASTM D2665)
- P = Prism load soil pressure on the buried pipe from the weight of the soil above it - lb/in<sup>2</sup> (MPa)  
(Values can be found in Table 4-18)
- L = Live load on buried pipe from traffic on the surface above it - lb/in<sup>2</sup> (MPa)  
(Values can be found in Table 4-19)
- PS = Pipe Stiffness to resist deflection in an unburied state per ASTM D2412 - lb/in<sup>2</sup> (MPa)  
(Values can be found in Table 4-17)
- E' = Modulus of soil reaction on top of buried pipe - lb/in<sup>2</sup> (MPa)  
(Values can be found in Table 4-20)

**Equation (4-1) - Imperial**

4" Industrial Plus PVC Schedule 80 pipe is to be buried 10ft under E80 railway traffic. The soil is coarse grained with little to no fines and with a high proctor and 110 lbs/ft<sup>3</sup> soil density. Will this be an appropriate application for 4" Schedule 80 Industrial Plus PVC Pipe?

P = 7.64 psi                      PS = 996 psi

L = 7.64 psi                      E' = 3000 psi

$$y = \frac{10 (7.64 \text{ psi} + 7.64 \text{ psi})}{0.149 (996 \text{ psi}) + 0.061 (3000 \text{ psi})}$$

y = 0.46% ± 0.5%



**Table 4-18: Prism load soil pressure (soil density) (P)**

<b>Prism Load Soil Pressure (psi)</b>						
<b>Height of Soil Cover (ft)</b>	<b>Soil Unit Weight (lb/ft<sup>3</sup>)</b>					
	<b>100</b>	<b>110</b>	<b>120</b>	<b>130</b>	<b>140</b>	<b>150</b>
1	0.69	0.76	0.83	0.90	0.97	1.04
2	1.39	1.53	1.67	1.81	1.94	2.08
3	2.08	2.29	2.50	2.71	2.92	3.13
4	2.78	3.06	3.33	3.61	3.89	4.17
5	3.47	3.82	4.17	4.51	4.86	5.21
6	4.17	4.58	5.00	5.42	5.83	6.25
7	4.86	5.35	5.83	6.32	6.81	7.29
8	5.56	6.11	6.67	7.22	7.78	8.33
9	6.25	6.88	7.50	8.13	8.75	9.38
10	6.94	7.64	8.33	9.03	9.72	10.42
12	8.33	9.17	10.00	10.83	11.67	12.50
14	9.72	10.69	11.67	12.64	13.61	14.58
16	11.11	12.22	13.33	14.44	15.56	16.67
18	12.50	13.75	15.00	16.25	17.50	18.75
20	13.89	15.28	16.67	18.06	19.44	20.83
25	17.36	19.10	20.83	22.57	24.31	26.04
30	20.83	22.92	25.00	27.08	29.17	31.25
35	24.31	26.74	29.17	31.60	34.03	36.46
40	27.78	30.56	33.33	36.11	38.89	41.67
45	31.25	34.38	37.50	40.63	43.75	46.88
50	34.72	38.19	41.67	45.14	48.61	52.08

<b>Prism Load Soil Pressure (MPa)</b>						
<b>Height of Soil Cover (m)</b>	<b>Soil Unit Weight (MPa/m)</b>					
	<b>0.0100</b>	<b>0.0150</b>	<b>0.020</b>	<b>0.0250</b>	<b>0.0300</b>	<b>0.0350</b>
0.25	0.0025	0.0038	0.0050	0.0063	0.0075	0.0088
0.5	0.0050	0.0075	0.0100	0.0125	0.0150	0.0175
0.75	0.0075	0.0113	0.0150	0.0188	0.0225	0.0263
1.0	0.0100	0.0150	0.0200	0.0250	0.0300	0.0350
1.5	0.0150	0.0225	0.0300	0.0375	0.0450	0.0525
2.0	0.0200	0.0300	0.0400	0.0500	0.0600	0.0700
2.5	0.0250	0.0375	0.0500	0.0625	0.0750	0.0875
3.0	0.0300	0.0450	0.0600	0.0750	0.0900	0.1050
3.5	0.0350	0.0525	0.0700	0.0875	0.1050	0.1225
4.0	0.0400	0.0600	0.0800	0.1000	0.1200	0.1400
4.5	0.0450	0.0675	0.0900	0.1125	0.1350	0.1575
5.0	0.0500	0.0750	0.1000	0.1250	0.1500	0.1750
6	0.0600	0.0900	0.1200	0.1500	0.1800	0.2100
7	0.0700	0.1050	0.1400	0.1750	0.2100	0.2450
8	0.0800	0.1200	0.1600	0.2000	0.2400	0.2800
9	0.0900	0.1350	0.1800	0.2250	0.2700	0.3150
10	0.1000	0.1500	0.2000	0.2500	0.3000	0.3500
11	0.1100	0.1650	0.2200	0.2750	0.3300	0.3850
12	0.1200	0.1800	0.2400	0.3000	0.3600	0.4200
13	0.1300	0.1950	0.2600	0.3250	0.3900	0.4550
14	0.1400	0.2100	0.2800	0.3500	0.4200	0.4900
15	0.1500	0.2250	0.3000	0.3750	0.4500	0.5250

**Table 4-19: Live load on buried pipe (traffic load) (L)**

<b>Live Load (psi)</b>			
<b>Height of Cover (ft)</b>	<b>Highway H201</b>	<b>Railway E802</b>	<b>Airport 3</b>
1	12.50		
2	5.56	26.39	13.14
3	4.17	23.61	12.28
4	2.78	18.40	11.27
5	1.74	16.67	10.09
6	1.39	15.63	8.79
7	1.22	12.15	7.85
8	0.69	11.11	6.93
10	N	7.64	6.09
12	N	5.56	4.76
14	N	4.17	3.06
16	N	3.47	2.29
18	N	2.78	1.91
20	N	2.08	1.53
22	N	1.91	1.14
24	N	1.74	1.05
26	N	1.39	N
28	N	1.04	N
30	N	0.69	N

<b>Live Load (MPa)</b>			
<b>Height of Cover (m)</b>	<b>Highway H201</b>	<b>Railway E802</b>	<b>Airport 3</b>
0.3	0.086		
0.6	0.038	0.182	0.091
0.9	0.029	0.163	0.085
1.2	0.019	0.127	0.078
1.5	0.012	0.115	0.070
1.8	0.010	0.108	0.061
2.1	0.008	0.084	0.054
2.4	0.005	0.077	0.048
3.0	N	0.053	0.042
3.7	N	0.038	0.033
4.3	N	0.029	0.021
4.9	N	0.024	0.016
5.5	N	0.019	0.013
6.1	N	0.014	0.011
6.7	N	0.013	0.008
7.3	N	0.012	0.007
7.9	N	0.010	N
8.5	N	0.007	N
9.1	N	0.005	N

**Table 4-20: Average values of modulus of soil reaction (soil type) (E')**

Pipe Bedding Materials		E' For Degree of Compaction of Pipe Zone Backfill, psi (MPa)			
Soil Class	Soil Type (United Classification System per ASTM D2487)	Loose or Dumped	Slight <85% Proctor, <40% Relative density	Moderate 85%-90% Proctor, 40%-70% Relative density	High >95% Proctor, >70% Relative density
<b>Class V</b>	"Fine-grained Soils (LL<50b) Soils with medium to high plasticity, CH, MH, CH-MH"	No data available; consult a professional soils engineer; otherwise, use E'=0			
<b>Class IV</b>	"Fine-grained Soils (LL<50) Soils with medium to no plasticity, CL, ML, ML-CL, with less than 25% coarse-grained particles"	"50 (0.345)"	"200 (1.379)"	"400 (2.758)"	"1000 (6.895)"
<b>Class III</b>	"Fine-grained Soils (LL<50) Soils with medium to no plasticity, CL, ML, ML-CL, with more than 25% coarse-grained particles"	"100 (0.689)"	"400 (2.758)"	"1000 (6.895)"	"2000 (13.790)"
<b>Class II</b>	"Coarse-grained Soils with Little or no Fines GW, GP, SW, SPc contains less than 12% fines"	"200 (1.379)"	"1000 (6.895)"	"2000 (13.790)"	"3000 (20.684)"
<b>Class I</b>	Crushed Rock	"1000 (6.895)"	"3000 (20.684)"	"3000 (20.684)"	"3000 (20.684)"
	Accuracy in Terms of Percentage Deflection	±2	±2	±1	±0.5

In order to determine the allowable pipe burial depth, the pipe dimension, soil density, traffic load, soil type, and compaction density of embedment soil will be obtained from the tables provided. The values obtained would then be used in the Modified Iowa Equation in order to determine the predicted percentage of pipe deflection. GF Piping Systems does not recommend the use of GF Piping Systems PVC or CPVC piping when the pipe diameter is deflected more than 5% due to the possibility of pipe failure. Therefore, it would not be recommended to use GF Piping Systems piping when the percentage of deflection, obtained through the Modified Iowa Equation, is greater than 5%.

**Above-ground Installation**

The system must be designed and installed to compensate for movement resulting from thermal expansion and contraction. This is particularly true for above ground applications installed outdoors and within unoccupied buildings where ambient temperature swings can be significant. For example, a system installed in an unoccupied (i.e. unheated) building during the winter months will expand considerably when temperatures rise. The direct opposite is true for systems installed at higher ambient temperatures where temperatures may fall considerably after installation. This fact must be addressed with proper system design to compensate for movement generated as the result of the effects of thermal expansion and/or contraction of the piping. Refer to Page 23 for additional information.

PVC and CPVC piping products have been used successfully in outdoor applications when proper recommendations are followed. As with any other piping, the system must be protected from freezing in applications subject to colder

temperatures. Many standard cold weather piping design and installation practices can be used to protect the system from freezing such as the use of pipe insulation, anti-freeze solutions, and heat trace tapes. The manufacturers of these products should be consulted for suitability and compatibility of their products for use with PVC and CPVC prior to use. GF Piping Systems recommends that PVC and CPVC piping products exposed to the effects of sunlight (UV radiation) be painted with a light colored acrylic or latex paint that is chemically compatible with PVC and CPVC products. Compatibility information should be confirmed with the paint manufacturer. The use of oil-based paints is not recommended. When painted, the effects of exposure to sunlight are significantly reduced; however, consideration should be given to the effects of expansion/contraction of the system caused by heat absorption in outdoor applications. The use of a light colored, reflective paint coating will reduce this effect; however, the system must also be designed and installed in such a manner to reduce the effects of movement due to thermal expansion.

**Sunlight and Thermoplastics**

Thermoplastic pipe and fittings have been used extensively outdoors and are resistant to weathering but they may have some surface degradation from intense and prolonged exposure to ultraviolet (UV) rays in sunlight. This degradation is a surface effect which reduces the impact rating but has no effect on the temperature capability, chemical resistance, or pressure rating of the pipe. This reduced impact rating can be eliminated by removal of the affected surface area and covering with a good bonding exterior latex paint.

To guarantee maximum performance from Georg Fischer Piping Systems when exposed to specific conditions such as oxidation caused by exposure to direct sunlight, the recommendation for protection paint used in specific industrial applications is as follows:

1. Painting of Plastic Piping Systems is recommended if thermal expansion is not too great (i.e.  $\Delta T$  not more than 50°F, 28°C).
2. The paint should be a high pigment content exterior grade latex paint.
3. The pipe should be clean. A light sanding will greatly aid bonding to pipe.
4. Avoid any chemical pretreatment procedure or ingredients being harmful to the plastic.

The latex paint must be applied thick enough (probably several coats) to create an opaque covering. If the pipe and fittings are prepared properly for painting, a good grade of exterior latex should last for many years. White or light colored pigment paint is suggested as it offers a more reflective surface.

### Testing

Hydrostatic pressure testing (testing with water filled lines) is the only test method recommended and approved for pressure testing of GF Piping Systems piping products. During pressure testing, appropriate safety precautions must be taken to protect personnel and property from damage should a failure occur. The test pressure and duration of the pressure test performed should meet requirements of any local, state, or federal regulations as applicable. In the absence of any such requirements or regulations, the following procedures can be used to properly conduct a hydrostatic pressure test on newly installed PVC and CPVC piping systems.

Strict adherence to proper solvent cementing instructions and set and cure times is essential to ensure the highest system integrity prior to pressure testing. Particular attention should be paid to pipe sizes, temperature at time of installation, and any temperature variations over the set and cure period.

1. All solvent cemented connections in the system must be fully cured prior to filling the system with water.
2. Pipe must be adequately anchored/restrained to prevent movement during testing.
3. The system should not be tested until authorized and subsequently witnessed by the responsible inspector.
4. Extreme care shall be used to ensure complete venting of all entrapped air when filling the system with water. Entrapped air is a major cause of excessive surge pressures that result in burst failures of rigid plastic piping systems.
5. Air must be removed from the system to prevent it from being locked in the system when pressure is applied.

6. The system should include the use of air release and air/vacuum relief valves located at high points in the system to vent air during filling as well as during normal operation of the system.
7. The system must be filled slowly with water, venting air from valves at piping run ends and at elevations during the filling process. Whether a hydraulic hand pump or available water line pressure is used, any slow build-up of gauge pressure or any rapidly fluctuating gauge needle on a completely liquid filled system is a strong indication that entrapped air is present within the system. Should this occur, pressure should be immediately released and the line re-bled. Failure to do so can lead to a catastrophic failure when the water column is suddenly accelerated by the rapidly decompressing air should a faulty joint separate or other failure occur.
8. When testing thermoplastic piping systems, all tests should not exceed the pressure rating of the lowest rated component in the piping system (valve, union, or flange). Test the system at 150% of the designed operational pressure, i.e. if the system is designed to operate at 80 psi (5.5 bar), then the test will be done at 120 psi (8.25 bar).
9. Allow one hour for the system to stabilize after reaching the desired pressure. After the hour, in case of pressure drop, increase pressure back to the desired amount, and hold for 30 minutes. If the pressure drops by more than 6%, check the system for leaks.
10. A test period of two hours is usually considered satisfactory to demonstrate the integrity of the system.
11. If a leak is found, the pressure must be relieved and the failed section cut out, replaced, and allowed to cure properly prior to recharging and retesting the system.

GF Piping Systems recommends that large and/or complex systems be tested in segments as they are installed to permit evaluation and correction of improper installation techniques or other deficiencies as the project progresses.

**Warning: Use of compressed air or gas in PVC or CPVC pipe and fittings can cause explosive failures resulting in system damage, severe bodily injury, or death.**

**Compressed air or gases must never be used for testing of PVC or CPVC piping systems. Improper installation, especially poor workmanship in solvent cementing techniques, can lead to an abrupt release of tremendous stored energy in the presence of compressed air or gas. This abrupt release of energy creates a whipping action of the piping where shattering of pipe and fittings is then apt to occur at directional changes and at points where the system is rigidly restricted. This scenario creates a substantial safety hazard to personnel. In addition, secondary hairline stress fractures caused by this effect can also be initiated, which will tend to propagate over time resulting in additional failures. It is also known that**

**certain additives present in air compressor lubricants are not chemically compatible with plastic materials and will initiate stress cracking of the plastic further increasing the potential for additional failures. Refer to caution areas for additional information.**

## **Chemical Compatibility Awareness**

Thermoplastic piping continues to gain wide acceptance and use. Occasionally certain chemicals found in construction products and specific site preparations can cause damage to thermoplastic piping systems such as thread sealants, lubricants, anti-freeze solutions, fire stop materials, etc. It is important to verify the compatibility of materials that come in contact with the piping system to ensure long-term performance.

Always check with GF if you have questions regarding chemical compatibility. If chemical compatibility with the thermoplastic remains in question, it is recommended to isolate the suspect product from direct contact with the thermoplastic piping system.

In general, thermoplastics may be more susceptible to stress cracking agents that can be found in certain ancillary products. The following list has been generated to create awareness that the potential for damage exists. Please note that a chemical compatibility program exists where a list of acceptable and unacceptable products is maintained. Please contact the GF Technical Services Department for the latest information.

### **Thread Sealants**

Some thread paste sealants contain solvents or other chemical additives that can cause damage to thermoplastic pipe and fittings. Only compatible thread sealants and tapes should be used.

### **Fire Stop Materials**

Some fire stop sealants contain solvents or other chemical additives that can cause damage to thermoplastic pipe and fittings. Only compatible fire stop materials should be used.

### **Anti-Freeze Solutions**

DO NOT use glycol based antifreeze solutions. The use of improper anti-freeze solutions such as ethylene glycol, propylene glycol and/or contaminated glycerin solutions can cause stress cracking of thermoplastic pipe and fittings resulting in piping system failure.

### **Soldering/Hot Work**

Soldering of metallic components in close proximity to thermoplastic piping systems will cause damage to the system. Direct contact with heat (open flame), solder, and soldering flux is not recommended. These types of products should be isolated from direct contact with thermoplastic piping products. Thermoplastic contact with solder flux can cause cracks, leaks, and breaks in the piping system. Any thermoplastic pipe or fittings that have solder flux on them, as

identified by staining or discoloration of the pipe and fittings, should be removed and replaced with new materials.

### **Flexible Wire**

Direct contact with flexible wire and cable should be avoided as the insulation for the wire and cable can contain plasticizers that can cause thermoplastic piping systems to crack, leak, or break. The finished installation should be inspected to verify that the thermoplastic piping system is not being used to support wire or cable and that runs of wire and cable have not been pulled over the installed thermoplastic system. Additionally, the thermoplastic piping systems should not be supported with electrical cable or flexible wiring, and all hanger support recommendations should be followed.

### **Steel Pipe Transitions**

Transitions from steel pipe to thermoplastic pipe can be made through a variety of methods such as threaded, flanged, and grooved transition components. Occasionally steel pipe may contain residual oils that were used to aid in the metal cutting process. Some of the oils used for this purpose may be incompatible with thermoplastics. Cutting oils should be removed from steel pipe prior to connecting to thermoplastic pipe by fully cleaning the inside and outside of the pipe before it is assembled in the piping system. Care should be taken when selecting cleaning agents to avoid further contamination of the pipe with incompatible detergents. If cutting oil is used consult with the manufacturer of the cutting oil for a specific recommendation as to compatibility with thermoplastic systems.

### **Paint**

Oil or solvent based paints may be chemically incompatible with thermoplastics. Water based acrylic or latex paint is the preferred paint to use on thermoplastic pipe and fittings. The installation contractor must take responsibility for obtaining approval from the authority having jurisdiction to cover the markings on the product (i.e. product identification, listing marks, etc.) and to change the color of the pipe and fittings from its identifiable color prior to use.

### **Cooking Oils and Grease**

When thermoplastic pipe is installed in kitchen areas the pipe must be protected from contact with grease or cooking oils. Certain cooking oils can cause thermoplastics to crack, leak, or break when applied to the piping system. Consideration must be given to not only protecting the pipe from direct contact with cooking oils and/or grease but also contact that may occur from airborne grease or oil from the environment. Exposed piping in areas where thermoplastics might come in contact with cooking oils and grease should be protected using a complete coating of high-quality, water-based paint that fully protects the piping system.

### **Rubber and Flexible Materials**

Thermoplastics are typically not compatible with rubber and flexible plastic materials as these materials often contain certain types of plasticizers which when placed in contact

with thermoplastics can cause the piping system to crack, leak, or break. Incompatible plasticizers include, but are not limited to, phthalates, adipates, trimellitates, and dibenzoates. Incompatible rubber and flexible plastic materials can be found in hoses and tank linings and in the fluids that come in contact with them.

### **Spray-On Coatings**

Certain types of spray-on coatings that form a peel-able film to protect fixtures during construction may be incompatible with thermoplastics. Care should be used to protect exposed piping from over-spray when this type of protective coating is applied.

### **Termiticides and Insecticides**

When performing installations where the presence of insecticides or termiticides is likely, care should be taken to isolate thermoplastic pipe from direct contact with large quantities of these chemicals. Thermoplastics can be damaged when termiticides or insecticides are injected into the annular space between the pipe wall and sleeving material, trapping the termiticides or insecticide against the pipe wall. Termiticide and insecticide applications per label instructions in an open-air environment should not pose a problem; however, puddling of termiticides on or near thermoplastic pipe may cause failures. In areas where puddling is more likely extra care should be taken to avoid puddling of termiticides. Before using an insecticide or termiticide, be sure to consult the manufacturer's installation guide for proper application instructions. A list of compatible insecticides or termiticides is available.

### **Mold Abatement and Fungicides**

Thermoplastic piping can be damaged by mold abatement and fungicide products. These products can damage thermoplastic piping systems by causing cracks, leaks, or breaks in the system. When performing repairs or modifications, care should be taken to isolate the thermoplastic piping system from direct contact with fungicide products. When repairs are made to an existing system and the possibility exists that fungicides will be applied to treat damp drywall and wood framing surrounding the repair site, exposed piping should be sleeved with a compatible plastic sleeving or pipe insulation material to prevent direct contact of the fungicide with the thermoplastic piping system.

### **General Safety Information**

Thermoplastic piping is a general term applied to a variety of different plastics. A user of thermoplastic piping should select the kind of thermoplastic best suited for his use. Special care must be used to apply proper engineering, design, and installation procedures.

GF Piping Systems recommends against the use of its thermoplastic piping systems for transport or storage of compressed air or gases. Entrapped air must be removed from liquid piping systems so that no air remains locked in the system when pressure is applied to the liquid. Excessive surge pressure must be avoided. Surge pressure can develop if liquid movement through the pipe is near maximum velocities and valves are closed abruptly. Recommended velocity is generally considered to be 5 ft/s (1.5 m/s), not to exceed 10 ft/s (3.2 m/s).

Failures can occur at the joints connecting the pipe and fittings. For example, threaded joints have a diminished wall thickness because of the cut of the thread into the wall. Also, improperly cemented joints will leave the strength of the joint impaired.

Temperature extremes, both hot and cold, or changes in temperature can result in failures of thermoplastic pipe in the following cases:

1. Breakage or other damage on the job site in cold weather can be caused by impact with tools, vehicles, or rocks.
2. Heat of solution of chemicals or heat from other sources can cause failure because the piping systems will be distorted.
3. Wide variations in temperature when the pipe is restrained as in concrete or is otherwise anchored can lead to cracking and breakage.
4. When heat is introduced by a pump, especially when on recirculation, the pipe or joints can fail.
5. Expansion and contraction can cause leakage or breaks at joints.

Crush strength of the thermoplastic pipe and fittings should not be exceeded. Similarly, excessive suction or vacuum must be avoided.

Since thermoplastics are relatively soft, they can be damaged using pipe wrenches on threaded connections.

Pipe should not be used as a ground for electrical systems and conditions of static electricity should not be created through excessive friction. Welding or torch cutting operations near thermoplastic pipe can cause damage to the pipe due to burning by sparks or overheating.

High chromic acid solutions and high nitric acids can lead to stress cracking; also, when certain chemicals and solvents are absorbed into the pipe and fittings surfaces, softness will develop in the thermoplastic which can lead to weeping or rupture.



## Safety Information on Primers and Solvent Cements

Over a period of 50 years, millions of solvent cemented joints have been made with only rare cases of mishap. However, since these products are flammable and contain chemical solvents, appropriate safety precautions should be taken.

Virtually all solvent cements and primers for thermoplastic pipe are flammable and should not be used or stored near heat, spark, or open flames. Do not smoke during use. Cement should be stored in closed containers at temperatures above 40°F (4.4°C). They should be used only with adequate ventilation. In confined or partially enclosed areas, a ventilating device should be used to remove vapors and minimize their inhalation.

Respirators specially designed to minimize the inhalation of organic vapors can also be used. They are commercially available. Containers should be kept tightly closed when not in use and covered as much as possible when in use. Use of an application can with applicator attached to a lid is especially recommended.

Avoid frequent contact with skin and eyes as it may be absorbed through the skin and may cause eye injury. In case of contact, flush with plenty of water for 15 minutes. If irritation persists, get medical attention. If swallowed, call a physician immediately and follow precautionary statements given on the side panel of the cement container. Keep out of reach of children.

### Warning: Use Caution with Welding Torches

On projects where thermoplastics are being installed or have been recently solvent welded, special caution should be taken where using welding torches or other equipment where sparks might be involved. Flammable vapors from cemented joints sometimes linger within or around a piping system for some time.

Special care must be taken in situations where welding torches may be used in close proximity to thermoplastic piping. In all cases, lines should be purged to remove solvent vapors before welding.

### Warning: Use Caution with Calcium Hypochlorite

Do not use a dry, granular calcium hypochlorite as a disinfecting material for water purification in potable water piping systems. The introductions of granules or pellets of calcium hypochlorite with solvent cements and primers, including their vapors, may result in violent chemical reactions if a water solution is not used. It is advisable to purify lines by pumping chlorinated water into the piping system; this solution will be nonvolatile. Furthermore, dry, granular calcium hypochlorite should not be stored or used near solvent cements or primers.

Accidents and injuries have seldom occurred in the use of our products. Help maintain and improve this excellent record by following the above recommendations.

## Use of Compressed Air or Gas

GF Piping Systems PVC and CPVC piping systems are considered rigid thermoplastic materials. GF Piping Systems does not recommend the use of PVC or CPVC piping products for the testing, transport, or storage of compressed air or gases. The compressibility of air and/or other gases result in tremendous amounts of stored energy, even at lower pressures. Should a failure occur in a compressed air or gas system for any reason (i.e. improper assembly, mechanical damage, etc.) the failure mode will be very dramatic in nature due to the physical characteristics of the rigid piping in combination with the immediate release of this stored energy. Under these conditions the velocity created by rapidly escaping air and the resultant failure mode can throw shards of thermoplastic in multiple directions. This scenario creates a substantial hazard to personnel and property within the vicinity of the piping should a failure occur. Several cautionary statements and alerts against the use of rigid thermoplastic piping for use with compressed air or gases are available through the Plastic Pipe Institute (PPI), American Society for Testing and Materials (ASTM), various other trade organizations, manufacturers, safety codes, and several state and federal agencies.

Compressed air or other gases should never be used in testing. Extreme care should be used to assure complete venting of all entrapped air when filling the system with water or other liquids used in testing. Whether a hydraulic hand pump or available water line pressure is used, any slow build-up of gauge pressure on a completely liquid filled line shows some entrapped air in the system. Pressure should be immediately released and the line re-bled. Failure to do this can lead to catastrophic failure when the decompressing gas suddenly accelerates the solid water column if a faulty joint separates.

PVC and CPVC are not recommended for compressed air lines. Improper installation, especially poor cementing techniques, can lead to an abrupt release of tremendous stored energy. Shattering of pipe and fittings is then apt to occur at directional changes and at points where the system is rigidly restrained due to the instantaneous "whipping" action imparted by the escaping air. Internal surface cracks due to stress can be initiated which will tend to propagate and cause shattering, hairline cracks, or pinhole cracks over a period of time. There is also evidence that certain additives to system lubricants will initiate internal stress cracking which will lead to similar failure over extended periods of time.

### Disclaimer of Liability

As the conditions or methods of use are beyond our control, we do not assume liability for any use of this material. Information contained herein is believed to be true and accurate, but all statements or suggestions are made without warranty, expressed or implied, regarding accuracy of the information, the hazards connected with the use of the

accurate, but all statements or suggestions are made without warranty, expressed or implied, regarding accuracy of the information, the hazards connected with the use of the material, or the results to be obtained from the use thereof. Compliance with all applicable federal, state, and local laws and regulations remains the responsibility of the user.

## Safety Alerts

Several varieties of safety alerts and related messages appear in this catalog. Please be sure you understand the meaning of the key words that identify each type of alert.

**“Warning” signifies hazards or unsafe practices that can cause severe personal injury or death if instructions, including recommended precautions, are not followed.**

**“Caution” signifies hazards or unsafe practices that can cause minor injury or product or property damage if instructions, including recommended precautions, are not followed.**

**“Note” signifies important special instructions.**

The data furnished herein is provided as a courtesy and is based on past experience, limited testing, and other information believed to be reliable. This information may be considered as a basis for recommendation only. No guarantee is made as to its accuracy or suitability for particular applications.

# List of Symbols

Symbols	Definition	Units
<b>c</b>	Distance from Neutral Axis	in (mm)
<b>C</b>	Constant for Inside Roughness	-
<b>C<sub>T</sub></b>	Thrust constant	-
<b>D<sub>avg</sub></b>	Average Pipe Diameter	in (mm)
<b>D<sub>i</sub></b>	Inside Pipe Diameter	in (mm)
<b>D<sub>o</sub></b>	Outside Pipe Diameter	in (mm)
<b>DPL</b>	Deflected Pipe Length	in (mm)
<b>E</b>	Modulus of Elasticity	psi (Mpa)
<b>E'</b>	Modulus of Soil Reaction	psi (MPa)
<b>f</b>	Friction Head in ft (m) of Water per 100 ft (100 m) of Pipe	ft/100 ft (m/100m)
<b>F<sub>R</sub></b>	Joint Resistance to Thrust	lb (N)
<b>F<sub>T</sub></b>	Thrust Force	lb (N)
<b>I</b>	Moment of Inertia	in <sup>4</sup> (mm <sup>4</sup> )
<b>L</b>	Length of Straight Run at Installation	in (mm)
<b>L</b>	Live Load	psi (MPa)
<b>L<sub>E</sub></b>	Length of Expansion Joint	in (mm)
<b>L<sub>S</sub></b>	Support Spacing	in (mm)
<b>M</b>	Moment	lb-in (N-mm)
<b>ó</b>	Compressive Strength	psi (Mpa)
<b>P</b>	Internal Pressure	psi (bar)
<b>P</b>	Prism Load Soil Pressure	psi (MPa)
<b>P<sub>c</sub></b>	Critical Collapse Pressure	psi (bar)
<b>P<sub>s</sub></b>	Surge Pressure	psi (bar)
<b>PS</b>	Pipe Stiffness	psi (MPa)
<b>P<sub>w</sub></b>	Working Pressure	psi (bar)
<b>P<sub>x</sub></b>	Piston Installation Position	in (mm)
<b>Q</b>	Flow Rate	gal/min (L/min)
<b>S</b>	Circumferential Stress	psi (Mpa)
<b>t</b>	Wall Thickness	in (mm)
<b>T<sub>amb</sub></b>	Ambient Temperature	°F (°C)
<b>T<sub>max</sub></b>	Maximum Temperature	°F (°C)
<b>T<sub>min</sub></b>	Minimum Temperature	°F (°C)
<b>V</b>	Liquid Velocity	ft/s (m/s)
<b>w</b>	Weight per Unit Length	lb/in (N/mm)
<b>y</b>	Percent Deflection	% (%)
<b>α</b>	Coefficient of Thermal Linear Expansion	in/in°F (mm/mm°C)
<b>γ</b>	Specific Gravity	-
<b>ΔL</b>	Change in Length Due to Thermal Expansion	in (mm)
<b>ΔT</b>	Maximum Change in Temperature Between Installation and Operation	°F (°C)
<b>τ<sub>c</sub></b>	Shear Strength of Cement Bond	psi (MPa)
<b>v</b>	Poisson's Ratio	-

# Glossary

**ALLOWABLE STRESS** The maximum force per unit area that may be safely applied to a pipe.

**BELL END** The enlarged portion of a pipe that resembles the socket portion of a fitting and that is intended to be used to make a joint by inserting a piece of pipe into it. Joining may be accomplished by solvent cements, adhesives, or mechanical techniques.

**BEND** A fitting either molded separately or formed from pipe for the purpose of accommodating a directional change.

**BEVELED PIPE** A pipe with an end chamfered to mate or adjust to another surface or to assist in assembly.

**BOND** To attach by means of an adhesive.

**CEMENT** A dispersion of "solution" of un-vulcanized rubber or a plastic in a volatile solvent and may or may not be an adhesive composition.

**CHAMFERED PIPE** A pipe with a conical surface (angle) made by cutting off the edge around the outside diameter on the end of a pipe.

**COLLAPSE** The buckling or crushing of a plastic pipe from external forces, such as earth loads or external hydrostatic load.

**CORROSIVE SUBSTANCES** Those substances, excluding seawater, that possess in their original stage the common property of being able through chemical action to cause damage by coming into contact with living tissues, the vessel, or its cargoes, when escaped from their containment.

**CRACK** Any narrow opening or fissure in the surface that is visible to the naked eye.

**CURE** The final stage in chemical bonding in which the chemically bonded polymer fully hardens and is ready to be pressure tested.

**DEBURRED PIPE** A pipe with the sharp edge and/or cutting remnants removed from the pipe end inner diameter or outer diameter edges.

**DEGRADATION** A deleterious change in the chemical structure of a plastic.

**DESIGN PRESSURE** The pressure to which each piping component of a piping system is designed.

**DESIGN TEMPERATURE** The maximum temperature at which each piping component is designed to operate.

**DRY PIPE SYSTEM** A system employing nozzles attached to a piping system connected to a water supply through a valve that is opened by the operation of a detection system installed in the same areas as the nozzles or opened manually. When this valve opens, water flows into the piping system and discharges from all nozzles attached thereto.

**DUCTILE FAILURE** A pipe failure mode which exhibits material deformation (stretching, elongation, or necking down) in the area of the break.

**ELASTICITY** The property of plastic materials in which they tend to recover their original size and shape after deformation.

**ELONGATION** The capacity to take deformation before failure in tension and is expressed as a percentage of the original length.

**FABRICATE** Method of forming a plastic into a finished article by machining, drawing, and similar operations.

**FITTING** A piping component used to join or terminate sections of pipe or to provide changes of direction or branching in a pipe system.

**FLEXURAL STRENGTH** The outer fiber stress, which must be attained in order to produce a given deformation under a beam load.

**FUSE** To join two plastic parts by softening the material by heat or solvents.

**GRAVITY DRAIN SYSTEM** A piping system in which flow is accomplished solely by the difference between the height of the inlet end and the outlet end.

**GRAVITY FLOW** Liquefied medium conveyance that is induced by a positive elevation head such as a downward pipeline slope or a higher elevation reservoir.

**HARDNESS** A comparative gauge of resistance to indentation, not of surface hardness or abrasion resistance.

**HOOP STRESS** The circumferential stress imposed on a cylindrical wall by internal pressure loading.

**HYDROSTATIC DESIGN STRESS** The estimated maximum tensile stress in the wall of the pipe in the circumferential orientation due to internal hydrostatic pressure that can be applied continuously with a high degree of certainty that failure of the pipe will not occur.

**IMPACT STRENGTH** Resistance or mechanical energy absorbed by a plastic part to such shocks as dropping and hard blows.

**JOINT** The location at which two pieces of pipe or a pipe and a fitting are connected together. The joint may be made by an adhesive, a solvent-cement, electro-fusion, mechanical device, etc.

**LONG-TERM HYDROSTATIC STRENGTH** The estimated tensile stress in the wall of the pipe in the circumferential orientation (hoop stress) that when applied continuously will cause failure of the pipe at 100,000 hours (11.43 years). These strengths are usually obtained by extrapolation of log-log regression equations or plots.

**LONGITUDINAL STRESS** The stress imposed on the long axis of any shape. It can be either a compressive or tensile stress.

**LUBRICANT** A substance used to decrease the friction between solid faces and sometimes used to improve processing characteristics of plastic compositions.

**MODULUS** The load in pounds per square inch or kilograms per square centimeter of initial cross sectional area necessary to produce a stated percentage elongation which is used in the physical testing of plastics.

**NON-FLAMMABLE** Will not support combustion

**NONRIGID PLASTIC** A plastic which has a stiffness or apparent modulus of elasticity of not over 10,000 psi at 73°F (23°C) which is determined in accordance with the Standard Method of Test for Stiffness in Flexure of Plastics.

**NON-TOXIC** Not poisonous.

**PIPE** Pressure-tight cylinders used to contain and convey fluids.

**PIPING SYSTEM** A network of piping and any associated pumps, designed and assembled to serve a specific purpose. Piping systems interface with, but exclude, major equipment, such as boilers, pressure vessels, tanks, diesel engines, turbines, etc.

**PLASTIC** A material that contains as an essential ingredient an organic substance of large molecular weight, is solid in its finished state, and, at some stage in the manufacture or in its processing into finished articles, can be shaped by flow.

**POLYMER** A product resulting from a chemical change involving the successive addition of a large number of relatively small molecules (monomer) to form the polymer and whose molecular weight is usually a multiple of that of the original substance.

**POLYVINYL CHLORIDE** Polymerized vinyl chloride, a synthetic resin, which when plasticized or softened with other chemicals has some rubber-like properties. It is derived from acetylene and anhydrous hydrochloric acid.

**PRESSURE** When expressed with reference to pipe, the force per unit area exerted by the medium in the pipe.

**PRESSURE PIPE** Pipe designed to resist continuous pressure exerted by the conveyed medium.

**PRESSURE RATING** The estimated maximum pressure that the medium in the pipe can exert continuously with a high degree of certainty that failure of the pipe will not occur.

**PRIMER** An organic solvent or a blend of solvents, which enhances adhesion, applied to plastic pipe and fittings prior to application of a solvent cement.

**RIGID PLASTIC** A plastic which has a stiffness or apparent modulus of elasticity greater than 100,000 psi at 73°F (23°C) when determined in accordance with the Standard Method of Test for Stiffness in Flexure of Plastics.

**SCHEDULE** A pipe size system (outside diameters and wall thicknesses) originated by the steel pipe industry.

**SELF-EXTINGUISHING** The ability of a plastic to resist burning when the source of heat or flame that ignited it is removed.

**SET** To convert an adhesive into a fixed or hardened state by chemical or physical action, such as condensation, polymerization, oxidation, vulcanization, gelation, hydration, or evaporation of volatile constituents.

**SOCKET** The portion of a jointing system that is designed to accept a plain-end pipe or spigot-end pipe.

**SOLVENT** The medium within which a substance is dissolved most commonly applied to liquids used to bring particular solids into solution, e.g., acetone is a solvent for PVC.

**SOLVENT CEMENT** A solvent adhesive that contains a solvent that dissolves or softens the surfaces being bonded so that the bonded assembly becomes essentially one piece of the same type of plastic.

**SPECIFIC GRAVITY** Ratio of the mass of a body to the mass of an equal volume of water at 39°F (4°C), or some other specified temperature.

**SPECIFIC HEAT** Ratio of the thermal capacity of a substance to that of water at 59°F (15°C).

**STRENGTH** The mechanical properties of a plastic such as a load or weight carrying ability and ability to withstand sharp blows. Strength properties include tensile, flexural, and tear strength, toughness, flexibility, etc.

**TENSILE STRENGTH** The capacity of a material to resist a force tending to stretch it. Ordinarily the term is used to denote the force required to stretch a material to rupture and is known variously as "breaking load", "breaking stress", "ultimate tensile strength", and sometimes erroneously as "breaking strain". In plastics testing, it is the load in pounds per square inch or kilos per square centimeter of original cross-sectional area supported at the moment of rupture by a piece of test sample on being elongated.

**THERMAL CONDUCTIVITY** Capacity of a plastic material to conduct heat.

**THERMAL EXPANSION** The increase in length of a dimension under the influence of a change in temperature.

**THERMOPLASTIC MATERIALS** Materials which soften when heated to normal processing temperatures without the occurrence of appreciable chemical change but are quickly hardened by cooling. Unlike the thermosetting materials they can be reheated to soften and retooled to "set" almost indefinitely; they may be formed and reformed many times by heat and pressure.

**VINYL CHLORIDE PLASTICS** Plastics based on resins made by the polymerization of vinyl chloride or copolymerization of vinyl chloride with minor amounts (not over 50%) of other unsaturated compounds.



**VINYL PLASTICS** Plastics based on resins made from vinyl monomers, except those specifically covered by other classifications such as acrylic and styrene plastics. Typical vinyl plastics are polyvinyl chloride, polyvinyl acetate, polyvinyl alcohol, polyvinyl butyral, and copolymers of vinyl monomers with unsaturated compounds.

**WET PIPE SYSTEM** A system employing nozzles attached to a piping system containing water and connected to a water supply so that water discharges immediately from the nozzles upon system activation.

**YIELD STRESS** The force which must be applied to a plastic to initiate flow.

## Reference Tables

### Pipe Dimensions

**Table 7-1: Pipe Dimensions for Schedule 40 pipe**

Nominal (in)	Imperial			Metric		
	OD (in)	t (in)	ID (in)	OD (mm)	t (mm)	ID (mm)
1/8	0.405	0.068	0.269	10.3	1.7	6.8
1/4	0.540	0.088	0.364	13.7	2.2	9.2
3/8	0.675	0.091	0.493	17.1	2.3	12.5
1/2	0.840	0.109	0.622	21.3	2.8	15.8
3/4	1.050	0.113	0.824	26.7	2.9	20.9
1	1.315	0.133	1.049	33.4	3.4	26.6
1 1/4	1.660	0.140	1.380	42.2	3.6	35.1
1 1/2	1.900	0.145	1.610	48.3	3.7	40.9
2	2.375	0.154	2.067	60.3	3.9	52.5
2 1/2	2.875	0.203	2.469	73.0	5.2	62.7
3	3.500	0.216	3.068	88.9	5.5	77.9
3 1/2	4.000	0.226	3.548	101.6	5.7	90.1
4	4.500	0.237	4.026	114.3	6.0	102.3
5	5.563	0.258	5.047	141.3	6.6	128.2
6	6.625	0.280	6.065	168.3	7.1	154.1
8	8.625	0.322	7.981	219.1	8.2	202.7
10	10.750	0.365	10.020	273.1	9.3	254.5
12	12.750	0.406	11.938	323.9	10.3	303.2
14	14.000	0.437	13.126	355.6	11.1	333.4
16	16.000	0.500	15.000	406.4	12.7	381.0
18	18.000	0.562	16.876	457.2	14.3	428.7
20	20.000	0.593	18.814	508.0	15.1	477.9
24	24.000	0.687	22.626	609.6	17.4	574.7

**Table 7-2: Pipe Dimensions for Schedule 80 pipe**

Nominal (in)	Imperial			Metric		
	OD (in)	t (in)	ID (in)	OD (mm)	t (mm)	ID (mm)
1/8	0.405	0.095	0.215	10.3	2.4	5.5
1/4	0.540	0.119	0.302	13.7	3.0	7.7
3/8	0.675	0.126	0.423	17.1	3.2	10.7
1/2	0.840	0.147	0.546	21.3	3.7	13.9
3/4	1.050	0.154	0.742	26.7	3.9	18.8
1	1.315	0.179	0.957	33.4	4.5	24.3
1 1/4	1.660	0.191	1.278	42.2	4.9	32.5
1 1/2	1.900	0.200	1.500	48.3	5.1	38.1
2	2.375	0.218	1.939	60.3	5.5	49.3
2 1/2	2.875	0.276	2.323	73.0	7.0	59.0
3	3.500	0.300	2.900	88.9	7.6	73.7
3 1/2	4.000	0.318	3.364	101.6	8.1	85.4
4	4.500	0.337	3.826	114.3	8.6	97.2
5	5.563	0.375	4.813	141.3	9.5	122.3
6	6.625	0.432	5.761	168.3	11.0	146.3
8	8.625	0.500	7.625	219.1	12.7	193.7
10	10.750	0.593	9.564	273.1	15.1	242.9
12	12.750	0.687	11.376	323.9	17.4	289.0
14	14.000	0.750	12.500	355.6	19.1	317.5
16	16.000	0.843	14.314	406.4	21.4	363.6
18	18.000	0.937	16.126	457.2	23.8	409.6
20	20.000	1.031	17.938	508.0	26.2	455.6
24	24.000	1.218	21.564	609.6	30.9	547.7

**Table 7-3: Pipe Dimensions for Schedule 120 pipe**

Nominal (in)	Imperial			Metric		
	OD (in)	t (in)	ID (in)	OD (mm)	t (mm)	ID (mm)
1/2	0.840	0.170	0.500	21.3	4.3	12.7
3/4	1.050	0.170	0.710	26.7	4.3	18.0
1	1.315	0.200	0.915	33.4	5.1	23.2
1 1/4	1.660	0.215	1.230	42.2	5.5	31.2
1 1/2	1.900	0.225	1.450	48.3	5.7	36.8
2	2.375	0.250	1.875	60.3	6.4	47.6
2 1/2	2.875	0.300	2.275	73.0	7.6	57.8
3	3.500	0.350	2.800	88.9	8.9	71.1
4	4.500	0.437	3.626	114.3	11.1	92.1
6	6.625	0.562	5.501	168.3	14.3	139.7
8	8.625	0.718	7.189	219.1	18.2	182.6

## Tolerances

Table 7-4: Outside diameters and tolerances for Schedule 40

Nominal (in)	Imperial			Metric		
	OD (in)	Average (in)	Maximum Out-of-Roundness (Maximum Minus Minimum Diameter) (in)	OD (mm)	Average (mm)	Maximum Out-of-Roundness (Maximum Minus Minimum Diameter) (mm)
1/8	0.405	0.004	0.016	10.3	0.10	0.41
1/4	0.540	0.004	0.016	13.7	0.10	0.41
3/8	0.675	0.004	0.016	17.1	0.10	0.41
1/2	0.840	0.004	0.016	21.3	0.10	0.41
3/4	1.050	0.004	0.020	26.7	0.10	0.51
1	1.315	0.005	0.020	33.4	0.13	0.51
1 1/4	1.660	0.005	0.024	42.2	0.13	0.61
1 1/2	1.900	0.006	0.024	48.3	0.15	0.61
2	2.375	0.006	0.024	60.3	0.15	0.61
2 1/2	2.875	0.007	0.030	73.0	0.18	0.76
3	3.500	0.008	0.030	88.9	0.20	0.76
3 1/2	4.000	0.008	0.100	101.6	0.20	2.54
4	4.500	0.009	0.100	114.3	0.23	2.54
5	5.563	0.01	0.100	141.3	0.25	2.54
6	6.625	0.011	0.100	168.3	0.28	2.54
8	8.625	0.015	0.150	219.1	0.38	3.81
10	10.750	0.015	0.150	273.1	0.38	3.81
12	12.750	0.015	0.150	323.9	0.38	3.81
14	14.000	0.015	0.200	355.6	0.38	5.08
16	16.000	0.019	0.320	406.4	0.48	8.13
18	18.000	0.019	0.360	457.2	0.48	9.14
20	20.000	0.023	0.400	508.0	0.58	10.16
24	24.000	0.031	0.480	609.6	0.79	12.19

Table 7-5: Outside diameters and tolerances for Schedule 80

Nominal (in)	Imperial			Metric		
	OD (in)	Average (in)	Maximum Out-of-Roundness (Maximum Minus Minimum Diameter) (in)	OD (mm)	Average (mm)	Maximum Out-of-Roundness (Maximum Minus Minimum Diameter) (mm)
1/8	0.405	0.004	0.016	10.3	0.10	0.41
1/4	0.540	0.004	0.016	13.7	0.10	0.41
3/8	0.675	0.004	0.016	17.1	0.10	0.41
1/2	0.840	0.004	0.016	21.3	0.10	0.41
3/4	1.050	0.004	0.020	26.7	0.10	0.51
1	1.315	0.005	0.020	33.4	0.13	0.51
1 1/4	1.660	0.005	0.024	42.2	0.13	0.61
1 1/2	1.900	0.006	0.024	48.3	0.15	0.61
2	2.375	0.006	0.024	60.3	0.15	0.61
2 1/2	2.875	0.007	0.030	73.0	0.18	0.76
3	3.500	0.008	0.030	88.9	0.20	0.76
3 1/2	4.000	0.008	0.030	101.6	0.20	0.76
4	4.500	0.009	0.030	114.3	0.23	0.76
5	5.563	0.01	0.060	141.3	0.25	1.52
6	6.625	0.011	0.070	168.3	0.28	1.78
8	8.625	0.015	0.150	219.1	0.38	3.81
10	10.750	0.015	0.150	273.1	0.38	3.81
12	12.750	0.015	0.150	323.9	0.38	3.81
14	14.000	0.015	0.200	355.6	0.38	5.08
16	16.000	0.019	0.320	406.4	0.48	8.13
18	18.000	0.019	0.360	457.2	0.48	9.14
20	20.000	0.023	0.400	508.0	0.58	10.16
24	24.000	0.031	0.480	609.6	0.79	12.19

**Table 7-6: Outside diameters and tolerances for Schedule 120**

Nominal (in)	Imperial			Metric		
	OD (in)	Average (in)	Maximum Out-of-Roundness (Maximum Minus Minimum Diameter) (in)	OD (mm)	Average (mm)	Maximum Out-of-Roundness (Maximum Minus Minimum Diameter) (mm)
½	0.840	0.004	0.016	21.3	0.10	0.41
¾	1.050	0.004	0.020	26.7	0.10	0.51
1	1.315	0.005	0.020	33.4	0.13	0.51
1¼	1.660	0.005	0.024	42.2	0.13	0.61
1½	1.900	0.006	0.024	48.3	0.15	0.61
2	2.375	0.006	0.024	60.3	0.15	0.61
2½	2.875	0.007	0.030	73.0	0.18	0.76
3	3.500	0.008	0.030	88.9	0.20	0.76
4	4.500	0.009	0.030	114.3	0.23	0.76
6	6.625	0.011	0.070	168.3	0.28	1.78
8	8.625	0.015	0.090	219.1	0.38	2.29

**Table 7-7: Wall thickness and tolerances for Schedule 40 pipe**

Nominal (in)	Imperial		Metric	
	Minimum (in)	Tolerance (in)	Minimum (mm)	Tolerance (mm)
⅝	0.405	0.068	10.3	1.7
¾	0.540	0.088	13.7	2.2
⅞	0.675	0.091	17.1	2.3
½	0.840	0.109	21.3	2.8
¾	1.050	0.113	26.7	2.9
1	1.315	0.133	33.4	3.4
1¼	1.660	0.140	42.2	3.6
1½	1.900	0.145	48.3	3.7
2	2.375	0.154	60.3	3.9
2½	2.875	0.203	73.0	5.2
3	3.500	0.216	88.9	5.5
3½	4.000	0.226	101.6	5.7
4	4.500	0.237	114.3	6.0
5	5.563	0.258	141.3	6.6
6	6.625	0.280	168.3	7.1
8	8.625	0.322	219.1	8.2
10	10.750	0.365	273.1	9.3
12	12.750	0.406	323.9	10.3
14	14.000	0.437	355.6	11.1
16	16.000	0.500	406.4	12.7
18	18.000	0.562	457.2	14.3
20	20.000	0.593	508.0	15.1
24	24.000	0.687	609.6	17.4

**Table 7-8: Wall thickness and tolerances for Schedule 80 pipe**

Nominal (in)	Imperial		Metric	
	Minimum (in)	Tolerance (in)	Minimum (mm)	Tolerance (mm)
1/8	0.095	0.020	2.41	0.51
1/4	0.119	0.020	3.02	0.51
3/8	0.126	0.020	3.20	0.51
1/2	0.147	0.020	3.73	0.51
3/4	0.154	0.020	3.91	0.51
1	0.179	0.021	4.55	0.53
1 1/4	0.191	0.023	4.85	0.58
1 1/2	0.200	0.024	5.08	0.61
2	0.218	0.026	5.54	0.66
2 1/2	0.276	0.033	7.01	0.84
3	0.300	0.036	7.62	0.91
3 1/2	0.318	0.038	8.08	0.97
4	0.337	0.040	8.56	1.02
5	0.375	0.045	9.53	1.14
6	0.432	0.052	10.97	1.32
8	0.500	0.060	12.70	1.52
10	0.593	0.071	15.06	1.80
12	0.687	0.082	17.45	2.08
14	0.750	0.090	19.05	2.29
16	0.843	0.101	21.41	2.57
18	0.937	0.112	23.80	2.84
20	1.031	0.124	26.19	3.15
24	1.218	0.146	30.94	3.71

**Table 7-9: Wall thickness and tolerances for Schedule 120 pipe**

Nominal (in)	Imperial		Metric	
	Minimum (in)	Tolerance (in)	Minimum (mm)	Tolerance (mm)
1/2	0.170	0.020	4.32	0.51
3/4	0.170	0.020	4.32	0.51
1	0.200	0.024	5.08	0.61
1 1/4	0.215	0.026	5.46	0.66
1 1/2	0.225	0.027	5.72	0.69
2	0.250	0.030	6.35	0.76
2 1/2	0.300	0.036	7.62	0.91
3	0.350	0.042	8.89	1.07
4	0.437	0.052	11.10	1.32
6	0.562	0.067	14.27	1.70
8	0.718	0.086	18.24	2.18

**Skid Quantities**

**Table 7-10: Pallet and truck load quantities**

Nominal (in)	Pieces per		Skid Dimensions	Plain End Skids per Truck	Belled End Skids per Truck	Plain End Skids per Truck	Belled End Skids per Truck
	Skid	Feet per Skid					
1/2	285	5700	44 x 08	32	N/A	32	N/A
3/4	263	5260	43 x 10	28	N/A	24	N/A
1	214	4280	44 x 12	24	N/A	20	N/A
1 1/4	118	2360	43 x 11	28	28	28	28
1 1/2	103	2060	43 x 12	28	28	28	28
2	83	1660	44 x 14	28	28	24	24
2 1/2	54	1080	44 x 14	28	28	24	24
3	42	840	42 x 16	24	24	24	24
4	26	520	44 x 16	24	24	24	24
5	20	400	42 x 19	20	20	20	20
6	17	340	43 x 21	16	16	16	16
8	11	220	36 x 27	12	12	12	12
10	7	140	43 x 23	12	12	12	12
12	5	100	36 x 27	12	12	12	12
14	5	100	42 x 31	12	12	12	12
16	3	60	28 x 19	10	10	10	10
18*	3	60	54 x 21	8	8	8	8
18*	2	40	36 x 21	8	8	8	8
20	2	40	40 x 23	16	16	16	16
24	2	40	48 x 28	12	12	12	12

**Pipe Capacity - Schedule 40**

Pipe Size (in)	ID (in)	Imperial			Metric		
		in <sup>3</sup>	ft <sup>3</sup>	Gallons	cm <sup>3</sup>	mm <sup>3</sup>	L
1/8	0.269	0.682	3.95 × 10 <sup>-4</sup>	2.95 × 10 <sup>-3</sup>	11.176	1.12 × 10 <sup>4</sup>	0.011
1/4	0.364	1.249	7.23 × 10 <sup>-4</sup>	5.41 × 10 <sup>-3</sup>	20.463	2.05 × 10 <sup>4</sup>	0.020
3/8	0.493	2.291	1.33 × 10 <sup>-3</sup>	9.92 × 10 <sup>-3</sup>	37.538	3.75 × 10 <sup>4</sup>	0.038
1/2	0.622	3.646	2.11 × 10 <sup>-3</sup>	0.016	59.752	5.98 × 10 <sup>4</sup>	0.060
3/4	0.824	6.399	3.70 × 10 <sup>-3</sup>	0.028	104.86	1.05 × 10 <sup>5</sup>	0.105
1	1.049	10.371	6.00 × 10 <sup>-3</sup>	0.045	169.95	1.70 × 10 <sup>5</sup>	0.170
1 1/4	1.380	17.949	0.010	0.078	294.12	2.94 × 10 <sup>5</sup>	0.294
1 1/2	1.610	24.430	0.014	0.106	400.34	4.00 × 10 <sup>5</sup>	0.400
2	2.067	40.267	0.023	0.174	659.86	6.60 × 10 <sup>5</sup>	0.660
2 1/2	2.469	57.453	0.033	0.249	941.49	9.41 × 10 <sup>5</sup>	0.941
3	3.068	88.712	0.051	0.384	1454	1.45 × 10 <sup>6</sup>	1.454
3 1/2	3.548	118.642	0.069	0.514	1944	1.94 × 10 <sup>6</sup>	1.944
4	4.026	152.763	0.088	0.661	2503	2.50 × 10 <sup>6</sup>	2.503
5	5.047	240.070	0.139	1.039	3934	3.93 × 10 <sup>6</sup>	3.934
6	6.065	346.683	0.201	1.501	5681	5.68 × 10 <sup>6</sup>	5.681
8	7.981	600.324	0.347	2.599	9838	9.84 × 10 <sup>6</sup>	9.838
10	10.020	946.251	0.548	4.096	15506	1.55 × 10 <sup>7</sup>	15.506
12	11.938	1343.180	0.777	5.815	22011	2.20 × 10 <sup>7</sup>	22.011
14	13.126	1623.813	0.940	7.029	26610	2.66 × 10 <sup>7</sup>	26.610
16	15.000	2120.575	1.227	9.180	34750	3.48 × 10 <sup>7</sup>	34.750
18	16.876	2684.171	1.553	11.620	43986	4.40 × 10 <sup>7</sup>	43.986
20	18.814	3336.057	1.931	14.442	54668	5.47 × 10 <sup>7</sup>	54.668
24	22.626	4824.882	2.792	20.887	79066	7.91 × 10 <sup>7</sup>	79.066

**Pipe Capacity - Schedule 80**

Pipe Size (in)	ID (in)	Imperial			Metric		
		in <sup>3</sup>	ft <sup>3</sup>	Gallons	cm <sup>3</sup>	mm <sup>3</sup>	L
1/8	0.269	0.682	3.95 × 10 <sup>-4</sup>	2.95 × 10 <sup>-3</sup>	11.176	1.12 × 10 <sup>4</sup>	0.011
1/4	0.364	1.249	7.23 × 10 <sup>-4</sup>	5.41 × 10 <sup>-3</sup>	20.463	2.05 × 10 <sup>4</sup>	0.020
3/8	0.493	2.291	1.33 × 10 <sup>-3</sup>	9.92 × 10 <sup>-3</sup>	37.538	3.75 × 10 <sup>4</sup>	0.038
1/2	0.622	3.646	2.11 × 10 <sup>-3</sup>	0.016	59.752	5.98 × 10 <sup>4</sup>	0.060
3/4	0.824	6.399	3.70 × 10 <sup>-3</sup>	0.028	104.86	1.05 × 10 <sup>5</sup>	0.105
1	1.049	10.371	6.00 × 10 <sup>-3</sup>	0.045	169.95	1.70 × 10 <sup>5</sup>	0.170
1 1/4	1.380	17.949	0.010	0.078	294.12	2.94 × 10 <sup>5</sup>	0.294
1 1/2	1.610	24.430	0.014	0.106	400.34	4.00 × 10 <sup>5</sup>	0.400
2	2.067	40.267	0.023	0.174	659.86	6.60 × 10 <sup>5</sup>	0.660
2 1/2	2.469	57.453	0.033	0.249	941.49	9.41 × 10 <sup>5</sup>	0.941
3	3.068	88.712	0.051	0.384	1454	1.45 × 10 <sup>6</sup>	1.454
3 1/2	3.548	118.642	0.069	0.514	1944	1.94 × 10 <sup>6</sup>	1.944
4	4.026	152.763	0.088	0.661	2503	2.50 × 10 <sup>6</sup>	2.503
5	5.047	240.070	0.139	1.039	3934	3.93 × 10 <sup>6</sup>	3.934
6	6.065	346.683	0.201	1.501	5681	5.68 × 10 <sup>6</sup>	5.681
8	7.981	600.324	0.347	2.599	9838	9.84 × 10 <sup>6</sup>	9.838
10	10.020	946.251	0.548	4.096	15506	1.55 × 10 <sup>7</sup>	15.506
12	11.938	1343.180	0.777	5.815	22011	2.20 × 10 <sup>7</sup>	22.011
14	13.126	1623.813	0.940	7.029	26610	2.66 × 10 <sup>7</sup>	26.610
16	15.000	2120.575	1.227	9.180	34750	3.48 × 10 <sup>7</sup>	34.750
18	16.876	2684.171	1.553	11.620	43986	4.40 × 10 <sup>7</sup>	43.986
20	18.814	3336.057	1.931	14.442	54668	5.47 × 10 <sup>7</sup>	54.668
24	22.626	4824.882	2.792	20.887	79066	7.91 × 10 <sup>7</sup>	79.066



**Pipe Capacity - Schedule 120**

Pipe Size (in)	ID (in)	Imperial			Metric		
		in <sup>3</sup>	ft <sup>3</sup>	Gallons	cm <sup>3</sup>	mm <sup>3</sup>	L
½	0.5	2.356	1.36 × 10 <sup>-3</sup>	0.010	38.611	3.86 × 10 <sup>4</sup>	0.039
¾	0.71	4.751	2.75 × 10 <sup>-3</sup>	0.021	77.856	7.79 × 10 <sup>4</sup>	0.078
1	0.915	7.891	4.57 × 10 <sup>-3</sup>	0.034	129.31	1.29 × 10 <sup>5</sup>	0.129
1¼	1.23	14.259	0.008	0.062	233.66	2.34 × 10 <sup>5</sup>	0.234
1½	1.45	19.816	0.011	0.086	324.72	3.25 × 10 <sup>5</sup>	0.325
2	1.875	33.134	0.019	0.143	542.97	5.43 × 10 <sup>5</sup>	0.543
2½	2.275	48.779	0.028	0.211	799.35	7.99 × 10 <sup>5</sup>	0.799
3	2.8	73.890	0.043	0.320	1211	1.21 × 10 <sup>6</sup>	1.211
4	3.626	123.916	0.072	0.536	2031	2.03 × 10 <sup>6</sup>	2.031
6	5.501	285.203	0.165	1.235	4674	4.67 × 10 <sup>6</sup>	4.674
8	7.189	487.089	0.282	2.109	7982	7.98 × 10 <sup>6</sup>	7.982

**Weight of Water**

Units	Pounds (lb)	Kilograms (kg)
1 gallon (gal)	8.35	3.79
1 liter (L)	2.21	1
1 cubic yard (yd <sup>3</sup> )	1686	765
1 cubic foot (ft <sup>3</sup> )	62.4	28.3
1 cubic inch (in <sup>3</sup> )	0.036	0.016
1 cubic centimeter (cm <sup>3</sup> )	0.002	0.001
1 cubic meter (m <sup>3</sup> )	2210	1000

**Length**

		Convert To, Multiply By:							
		millimeters (mm)	centimeters (cm)	meters (m)	kilometers (km)	inches (in)	feet (ft)	miles (mi)	nautical miles (nmi)
Convert From	millimeters (mm)	1	0.1	0.001	1×10 <sup>-6</sup>	0.0394	3.28×10 <sup>-3</sup>	6.22×10 <sup>-7</sup>	5.40×10 <sup>-7</sup>
	centimeters (cm)	10	1	0.01	1×10 <sup>-5</sup>	0.394	0.0328	6.22×10 <sup>-6</sup>	5.40×10 <sup>-6</sup>
	meters (m)	1000	100	1	0.001	39.4	3.28	6.21×10 <sup>-4</sup>	5.40×10 <sup>-4</sup>
	kilometers (km)	1×10 <sup>6</sup>	1×10 <sup>5</sup>	1000	1	3.94×10 <sup>4</sup>	3281	0.621	0.540
	inches (in)	25.4	2.54	0.0254	2.54×10 <sup>-5</sup>	1	0.0833	1.58×10 <sup>-5</sup>	1.37×10 <sup>-5</sup>
	feet (ft)	305	30.5	0.305	3.05×10 <sup>-4</sup>	12	1	1.89×10 <sup>-4</sup>	1.65×10 <sup>-4</sup>
	nautical miles (nmi)	1.85×10 <sup>6</sup>	1.85×10 <sup>5</sup>	1852	1.85	7.29×10 <sup>4</sup>	6076	1.15	1

**Area**

		Convert To, Multiply By:						
		millimeters (mm <sup>2</sup> )	square centimeters (cm <sup>2</sup> )	square meters (m <sup>2</sup> )	square kilometers (km <sup>2</sup> )	square inches (in <sup>2</sup> )	square feet (ft <sup>2</sup> )	square miles (mi <sup>2</sup> )
Convert From	square millimeters (mm <sup>2</sup> )	1	0.01	1×10 <sup>-6</sup>	1×10 <sup>-12</sup>	1.55×10 <sup>-3</sup>	1.08×10 <sup>-5</sup>	3.86×10 <sup>-13</sup>
	square centimeters (cm <sup>2</sup> )	100	1	1×10 <sup>-4</sup>	1×10 <sup>-10</sup>	0.155	1.08×10 <sup>-3</sup>	3.86×10 <sup>-11</sup>
	square meters (m <sup>2</sup> )	1×10 <sup>6</sup>	1×10 <sup>4</sup>	1	1×10 <sup>-6</sup>	1550	10.8	3.86×10 <sup>-7</sup>
	square kilometers (km <sup>2</sup> )	1×10 <sup>12</sup>	1×10 <sup>10</sup>	1×10 <sup>6</sup>	1	1.55×10 <sup>9</sup>	1.08×10 <sup>7</sup>	0.386
	square inches (in <sup>2</sup> )	645	6.45	6.45×10 <sup>-4</sup>	6.45×10 <sup>-10</sup>	1	6.94×10 <sup>-3</sup>	2.49×10 <sup>-10</sup>
	square feet (ft <sup>2</sup> )	9.29×10 <sup>4</sup>	929	0.0929	9.29×10 <sup>-8</sup>	144	1	3.59×10 <sup>-8</sup>
	square miles (mi <sup>2</sup> )	2.59×10 <sup>12</sup>	2.59×10 <sup>10</sup>	2.59×10 <sup>6</sup>	2.59	4.01×10 <sup>9</sup>	2.79×10 <sup>7</sup>	1

**Volume**

		Convert To, Multiply By:							
		cubic inches (in <sup>3</sup> )	cubic feet (ft <sup>3</sup> )	cubic yards (yd <sup>3</sup> )	gallons (gal)	cubic millimeters (mm <sup>3</sup> )	cubic centimeters (cm <sup>3</sup> )	cubic meters (m <sup>3</sup> )	liters (L)
Convert From	cubic inches (in <sup>3</sup> )	1	5.79×10 <sup>-4</sup>	2.15×10 <sup>-5</sup>	4.33×10 <sup>-3</sup>	1.64×10 <sup>4</sup>	16.4	1.64×10 <sup>-5</sup>	0.0164
	cubic feet (ft <sup>3</sup> )	1728	1	0.0370	7.46	2.83×10 <sup>7</sup>	2.83×10 <sup>4</sup>	0.0283	28.3
	cubic yards (yd <sup>3</sup> )	4.66×10 <sup>4</sup>	27.0	1	202	7.63×10 <sup>8</sup>	7.63×10 <sup>5</sup>	0.763	763
	gallons (gal)	231	0.134	4.95×10 <sup>-3</sup>	1	3.79×10 <sup>6</sup>	3.79×10 <sup>3</sup>	3.79×10 <sup>-3</sup>	3.79
	cubic millimeters (mm <sup>3</sup> )	6.10×10 <sup>-5</sup>	3.53×10 <sup>-8</sup>	1.31×10 <sup>-9</sup>	2.64×10 <sup>-7</sup>	1	1×10 <sup>-3</sup>	1×10 <sup>-9</sup>	1×10 <sup>-6</sup>
	cubic centimeters (cm <sup>3</sup> )	0.0610	3.53×10 <sup>-5</sup>	1.31×10 <sup>-6</sup>	2.64×10 <sup>-4</sup>	1000	1	1×10 <sup>-6</sup>	0.001
	cubic meters (m <sup>3</sup> )	6.10×10 <sup>4</sup>	35.3	1.31	264	1×10 <sup>9</sup>	1×10 <sup>6</sup>	1	1000
	liters (L)	61.0	0.0353	1.31×10 <sup>-3</sup>	0.264	1×10 <sup>6</sup>	1000	0.001	1

**Mass**

		Convert To, Multiply By:							
		ounce	pound	kilogram	metric slug	slug	short ton	metric ton	long ton
Convert From	ounce	1	0.0625	0.0283	2.89×10 <sup>-3</sup>	1.94×10 <sup>-3</sup>	3.13×10 <sup>-5</sup>	2.83×10 <sup>-5</sup>	2.79×10 <sup>-5</sup>
	pound	16.0	1	0.452	0.0463	0.0311	5.00×10 <sup>-4</sup>	4.54×10 <sup>-4</sup>	4.46×10 <sup>-4</sup>
	kilogram	35.3	2.21	1	0	0.0685	1.10×10 <sup>-3</sup>	1×10 <sup>-3</sup>	9.84×10 <sup>-4</sup>
	metric slug	346	21.6	9.81	1	0.671	0.0108	9.80×10 <sup>-3</sup>	9.62×10 <sup>-3</sup>
	slug	515	32.2	14.6	1.49	1	0.0161	0.0146	0.0144
	short ton	3.20×10 <sup>4</sup>	2000	907	92.5	62.2	1	0.909	0.893
	metric ton	3.53×10 <sup>4</sup>	2205	1000	102	68.5	1.1	1	0.98
	long ton	3.58×10 <sup>4</sup>	2240	1016	104	69.6	1.12	1.02	1

**Density**

		Convert To, Multiply By:					
		pounds per cubic inch (lbs/in <sup>3</sup> )	pounds per cubic foot (lbs/ft <sup>3</sup> )	pounds per gallon (lbs/gal)	grams per cubic centimeter (g/cm <sup>3</sup> )	grams per cubic millimeter (g/mm <sup>3</sup> )	grams per liter (g/L)
Convert From	pounds per cubic inch (lb/in <sup>3</sup> )	1	1727	231	27.7	0.0277	2.77×10 <sup>4</sup>
	pounds per cubic foot (lb/ft <sup>3</sup> )	5.79×10 <sup>-4</sup>	1	0.134	0.0160	1.60×10 <sup>-5</sup>	16
	pounds per gallon (lb/gal)	4.33×10 <sup>-3</sup>	7.48	1	0	0.0001	120
	grams per cubic centimeter (g/cm <sup>3</sup> )	3.61×10 <sup>-2</sup>	62.4	8.35	1	1000	1000
	grams per cubic millimeter (g/mm <sup>3</sup> )	36.1	6.20×10 <sup>4</sup>	8350	1×10 <sup>-3</sup>	1	1×10 <sup>-6</sup>
	grams per liter (g/L)	3.61×10 <sup>-5</sup>	6.24×10 <sup>-2</sup>	8.35×10 <sup>-3</sup>	0.001	1×10 <sup>6</sup>	1

**Force**

		Convert To, Multiply By:			
		dynes	newtons (N)	poundforce (lbf)	kilogramforce (kgf)
Convert From	dynes	1	1×10 <sup>-5</sup>	2.25×10 <sup>-6</sup>	1.02×10 <sup>-6</sup>
	newtons (N)	1×10 <sup>5</sup>	1	0.225	0.102
	poundforce (lbf)	4.45×10 <sup>5</sup>	4.45	1	0.454
	kilogramforce (kgf)	9.81×10 <sup>5</sup>	9.81	2.21	1

**Mass**

		Convert To, Multiply By:							
		ounce	pound	kilogram	metric slug	slug	short ton	metric ton	long ton
Convert From	ounce	1	0.0625	0.0283	2.89×10 <sup>-3</sup>	1.94×10 <sup>-3</sup>	3.13×10 <sup>-5</sup>	2.83×10 <sup>-5</sup>	2.79×10 <sup>-5</sup>
	pound	16.0	1	0.452	0.0463	0.0311	5.00×10 <sup>-4</sup>	4.54×10 <sup>-4</sup>	4.46×10 <sup>-4</sup>
	kilogram	35.3	2.21	1	0	0.0685	1.10×10 <sup>-3</sup>	1×10 <sup>-3</sup>	9.84×10 <sup>-4</sup>
	metric slug	346	21.6	9.81	1	0.671	0.0108	9.80×10 <sup>-3</sup>	9.62×10 <sup>-3</sup>
	slug	515	32.2	14.6	1.49	1	0.0161	0.0146	0.0144
	short ton	3.20×10 <sup>4</sup>	2000	907	92.5	62.2	1	0.909	0.893
	metric ton	3.53×10 <sup>4</sup>	2205	1000	102	68.5	1.1	1	0.98
	long ton	3.58×10 <sup>4</sup>	2240	1016	104	69.6	1.12	1.02	1

## Energy

		Convert To, Multiply By:					
		British thermal unit (BTU)	foot-pound (ft-lb)	horsepower-hour (hp-hr)	joules (J)	calorie (C)	kilowatt-hour (kW-hr)
Convert From	British thermal unit (BTU)	1	0.0625	0.0283	$2.89 \times 10^{-3}$	$1.94 \times 10^{-3}$	$3.13 \times 10^{-5}$
	foot-pound (ft-lb)	16.0	1	0.452	0.0463	0.0311	$5.00 \times 10^{-4}$
	horsepower-hour (hp-hr)	35.3	2.21	1	0	0.0685	$1.10 \times 10^{-3}$
	joules (J)	346	21.6	9.81	1	0.671	0.0108
	calorie (C)	515	32.2	14.6	1.49	1	0.0161
	kilowatt-hour (kW-hr)	$3.58 \times 10^4$	2240	1016	104	69.6	1.12

## Velocity

		Convert To, Multiply By:			
		feet per seconds (ft/s)	miles per hour (mph)	meters per second (m/s)	kilometers per hour (km/hr)
Convert From	feet per seconds (ft/s)	1	0.0625	0.0283	$2.89 \times 10^{-3}$
	miles per hour (mph)	16.0	1	0.452	0.0463
	meters per second (m/s)	35.3	2.21	1	0
	kilometers per hour (km/hr)	$3.58 \times 10^4$	2240	1016	104

## Flow Rate

		Convert To, Multiply By:			
		gallons per minute (GPM)	cubic feet per second (ft <sup>3</sup> /s)	liters per second (L/s)	cubic meters per hour (m <sup>3</sup> /hr)
Convert From	gallons per minute (GPM)	1	0.0625	0.0283	$2.89 \times 10^{-3}$
	cubic feet per second (ft <sup>3</sup> /s)	16.0	1	0.452	0.0463
	liters per second (L/s)	35.3	2.21	1	0
	cubic meters per hour (m <sup>3</sup> /hr)	$3.58 \times 10^4$	2240	1016	104

## Pressure

		Convert To, Multiply By:						
		pounds per square inch (psi)	atmospheres (atm)	kilograms per square meter (kg/m <sup>2</sup> )	feet of water (68°F)	millimeters of mercury (32°F)	bars	mega Pascals (MPa)
Convert From	pounds per square inch (psi)	1	0.0680	703	2.31	51.8	0.0690	6897
	atmospheres (atm)	14.7	1	$1.03 \times 10^4$	34.0	760	1.01	$1.01 \times 10^5$
	kilograms per square meter (kg/m <sup>2</sup> )	$1.42 \times 10^{-3}$	$9.68 \times 10^{-5}$	1	$3.29 \times 10^{-3}$	0.0735	$9.80 \times 10^{-5}$	9.80
	feet of water (68°F)	0.433	0.0295	304	1	22.4	0.0298	2984
	millimeters of mercury (32°F)	$1.93 \times 10^{-2}$	$1.32 \times 10^{-3}$	13.6	0.0447	1	$1.33 \times 10^{-3}$	133
	bars	14.5	0.987	$1.02 \times 10^4$	33.5	750	1	$1 \times 10^5$
	megaPascals (MPa)	$1.45 \times 10^{-4}$	$9.87 \times 10^{-6}$	0.102	$3.35 \times 10^{-4}$	$7.50 \times 10^{-3}$	$1 \times 10^{-5}$	1

# Useful Formulas and Symbols

## Symbols

D = outside diameter of pipe, inches

d = inside diameter of pipe, inches (Average based on mean wall)

t = average wall thickness, inches

P = pressure, psi

S = stress, psi

## Formulas

$A_o = D \times \pi/12 =$  outside pipe surface (ft<sup>2</sup>/ft)

$A_i = d \times \pi/12 =$  inside surface (ft<sup>2</sup>/ft)

$A = (D^2 - d^2) \times \pi/4 =$  cross-sectional plastic area (in<sup>2</sup>)

$A_f = d^2 \times \pi/4 =$  cross sectional flow area (in<sup>2</sup>).

$W_{pvc} = .632 \times A =$  weight of pipe (lb/ft)

$W_{cpvc} = .705 \times A =$  weight of pipe (lb/ft)

$W_w = 0.433 A_f =$  weight of water filling, lb. Per ft. length

$r_g = \sqrt{\frac{I}{A}} = \frac{\sqrt{D^2 + d^2}}{4} =$  radius of gyration, inches

$I = Ar_g^2 = .0491 (D^4 - d^4) =$  moment of inertia, inches fourth

$Z = 2I/D = 0.0982 \times (D^4 - d^4)/D =$  section modulus, inches cube

$W_{wfp} = W_{pvc}$  (or  $W_{cpvc}$ ) +  $W_w =$  weight of water filled pipe (lb/ft)

## Capacity

$V_g = V \times 0.004329 =$  Volume capacity (gal/ft)

$V = 0.7854 \times d^2 \times 12 =$  Volume capacity (in<sup>3</sup>/ft)

## Pressure Rating

$S = \frac{P(D - t)}{2t}$

# Industry Standards

## ASTM Standard Specifications

ASTM D1784	Standard Specification for Rigid Poly(Vinyl Chloride) (PVC) Compounds and Chlorinated Poly(Vinyl Chloride) (CPVC) Compounds
ASTM D1785	Standard Specification for Poly(Vinyl Chloride) (PVC) Plastic Pipe, Schedules 40, 80, and 120
ASTM D2241	Standard Specification for Poly(Vinyl Chloride) (PVC) Pressure-Rated Pipe (SDR Series)
ASTM D2464	Standard Specification for Threaded Poly(Vinyl Chloride) (PVC) Plastic Pipe Fittings, Schedule 80
ASTM D2466	Standard Specification for Poly(Vinyl Chloride) (PVC) Plastic Pipe Fittings, Schedule 40
ASTM D2467	Standard Specification for Poly(Vinyl Chloride) (PVC) Plastic Pipe Fittings, Schedule 80
ASTM D2665	Standard Specification for Poly(Vinyl Chloride) (PVC) Plastic Drain, Waste, and Vent Pipe and Fittings
ASTM D2672	Standard Specification for Joints for IPS PVC Pipe Using Solvent Cement
ASTM D2846	Standard Specification for Chlorinated Poly(Vinyl Chloride) (CPVC) Plastic Hot- and Cold-Water Distribution Systems
ASTM D3139	Standard Specification for Joints for Plastic Pressure Pipes Using Flexible Elastomeric Seals
ASTM D6263	Standard Specification for Extruded Rods and Bars Made From Rigid Poly(Vinyl Chloride) (PVC) and Chlorinated Poly(Vinyl Chloride) (CPVC)
ASTM F437	Standard Specification for Threaded Chlorinated Poly(Vinyl Chloride) (CPVC) Plastic Pipe Fittings, Schedule 80
ASTM F438	Standard Specification for Socket-Type Chlorinated Poly(Vinyl Chloride) (CPVC) Plastic Pipe Fittings, Schedule 40
ASTM F439	Standard Specification for Chlorinated Poly(Vinyl Chloride) (CPVC) Plastic Pipe Fittings, Schedule 80
ASTM F441	Standard Specification for Chlorinated Poly(Vinyl Chloride) (CPVC) Plastic Pipe, Schedules 40 and 80
ASTM F442	Standard Specification for Chlorinated Poly(Vinyl Chloride) (CPVC) Plastic Pipe (SDR-PR)
ASTM F477	Standard Specification for Elastomeric Seals (Gaskets) for Joining Plastic Pipe
ASTM F480	Standard Specification for Thermoplastic Well Casing Pipe and Couplings Made in Standard Dimension Ratios (SDR), Sch 40 and Sch 80
ASTM F493	Standard Specification for Solvent Cements for Chlorinated Poly(Vinyl Chloride) (CPVC) Plastic Pipe and Fittings
ASTM F656	Standard Specification for Primers for Use in Solvent Cement Joints of Poly(Vinyl Chloride) (PVC) Plastic Pipe and Fittings
ASTM F913	Standard Specification for Thermoplastic Elastomeric Seals (Gaskets) for Joining Plastic Pipe
ASTM F1866	Standard Specification for Poly(Vinyl Chloride) (PVC) Plastic Schedule 40 Drainage and DWV Fabricated Fittings

## ASTM Standard Test Methods

ASTM D1598	Standard Test Method for Time-to-Failure of Plastic Pipe Under Constant Internal Pressure
ASTM D1599	Standard Test Method for Resistance to Short-Time Hydraulic Pressure of Plastic Pipe, Tubing, and Fittings
ASTM D2122	Standard Test Method for Determining Dimensions of Thermoplastic Pipe and Fittings
ASTM D2152	Standard Test Method for Adequacy of Fusion of Extruded Poly(Vinyl Chloride) (PVC) Pipe and Molded Fittings by Acetone Immersion
ASTM D2412	Standard Test Method for Determination of External Loading Characteristics of Plastic Pipe by Parallel-Plate Loading
ASTM D2444	Standard Test Method for Determination of the Impact Resistance of Thermoplastic Pipe and Fittings by Means of a Tup (Falling Weight)
ASTM D2564	Standard Specification for Solvent Cements for Poly(Vinyl Chloride) (PVC) Plastic Piping Systems
ASTM D2837	Standard Test Method for Obtaining Hydrostatic Design Basis for Thermoplastic Pipe Materials or Pressure Design Basis for Thermoplastic Pipe Products



## ASTM Standard Practices

ASTM D2321	Standard Practice for Underground Installation of Thermoplastic Pipe for Sewers and Other Gravity-Flow Applications
ASTM D2774	Standard Practice for Underground Installation of Thermoplastic Pressure Piping
ASTM D2855	Standard Practice for the Two-Step (Primer and Solvent Cement) Method of Joining Poly (Vinyl Chloride )(PVC) or Chlorinated Poly (Vinyl Chloride) (CPVC) Pipe and Piping Components with Tapered Sockets
ASTM F402	Standard Practice for Safe Handling of Solvent Cements, Primers, and Cleaners Used for Joining Thermoplastic Pipe and Fittings
ASTM F610	Standard Practice for Evaluating the Quality of Molded Poly(Vinyl Chloride) (PVC) Plastic Pipe Fittings by the Heat Reversion Technique
ASTM F645	Standard Guide for Selection, Design, and Installation of Thermoplastic Water-Pressure Piping Systems
ASTM F690	Standard Practice for Underground Installation of Thermoplastic Pressure Piping Irrigation Systems
ASTM F1057	Standard Practice for Estimating the Quality of Extruded Poly (Vinyl Chloride) (PVC) Pipe by the Heat Reversion Technique

## Toxicology

NSF/ANSI Std 61	Drinking Water System Components - Health Effects
NSF/ANSI Std 14	Plastics Piping System Components and Related Materials
US FDA CFR	Title 21 - Food and Drugs

## Fire Performance

ASTM D2863	Standard Test Method for Measuring the Minimum Oxygen Concentration to Support Candle-Like Combustion of Plastics (Oxygen Index)
ASTM D635	Standard Test Method for Rate of Buring andor Extent and Time of Burning of Plastics in a Horizontal Position
ASTM E84	Standard Test Method for Surface Burning Characteristics of Building Materials
ASTM E162	Standard Test Method for Surface Flammability of Materials Using a Radiant Heat Energy Source
FM 1635	Plastic Pipe and Fittings for Automatic Sprinkler Systems
ANSI/FM 4910	American National Standard for Cleanroom Materials Flammability Test Protocol
UL 94	Standard for Tests for Flammability of Plastic Materials for Parts in Devices and Appliances
UL 723	Standard for Test for Surface Burning Characteristics of Building Materials
UL 1821	Standard for Thermoplastic Sprinkler Pipe and Fittings for Fire Protection Service
UL 1887	Standard for Fire Test of Plastic Sprinkler Pipe for Visible Flame and Smoke Characteristics
ULC CAN-S102.2	Method of Test for Surface Burning Characteristics of Flooring, Floor Coverings, and Miscellaneous Materials and Assemblies

## Other

CSA Standard B137.3-99	Rigid Polyvinyl Chloride (PVC) Pipe for Pressure Applications
------------------------	---

# Product Specifications

## PVC Industrial Pipe: Schedule 40

### Application

Corrosion resistant pressure pipe, IPS sizes 1/8" through 24", for use at temperatures up to and including 140°F (60°C). Pressure rating varies with schedule, pipe size, and temperature as stated in Section 3. Pipe is also suitable for PVC plastic drain, waste, and vent (DWV) applications. Generally resistant to most acids, bases, salts, aliphatic solutions, oxidants, and halogens. Chemical resistance data is available and should be referenced for proper material selection. Pipe exhibits excellent physical properties and flammability characteristics. Typical applications include chemical processing, plating, high purity applications, potable water systems, water and waste water treatment, drainage, irrigation, agricultural, and other applications involving corrosive fluid transfer.

### Scope

This specification outlines minimum manufacturing requirements for polyvinyl chloride (PVC) Schedule 40 iron pipe size (IPS) pressure pipe. This pipe is intended for use in applications where the fluid conveyed does not exceed 140°F (60°C). This pipe meets or exceeds the industry standards and requirements as set forth by ASTM D1785 Standard Specification for Poly(Vinyl Chloride) (PVC) Plastic Pipe, Schedules 40, 80, and 120, ASTM D2665 Standard Specification for Poly(Vinyl Chloride) (PVC) Plastic Drain, Waste, and Vent Pipe and Fittings, NSF/ANSI Standard 61 Drinking Water System Components – Health Effects, and NSF/ANSI Standard 14 Plastics Piping System Components and Related Materials.

### PVC Materials

The material used in the manufacture of the pipe shall be domestically produced rigid polyvinyl chloride (PVC) compound, Type I Grade I, with a Cell Classification of 12454 as defined in ASTM D1784 – Standard Specification for Rigid Poly(Vinyl Chloride) (PVC) Compounds and Chlorinated Poly(Vinyl Chloride) (CPVC) Compounds, trade name designation H707 PVC. This compound shall be white or gray in color as specified, and shall be approved by NSF International for use with potable water (NSF Std 61).

### Dimensions

All sizes of PVC Schedule 40 pipe shall be manufactured in strict accordance to the requirements of ASTM D1785 for physical dimensions and tolerances. PVC Sch 40 pipe sizes 1 1/4" through 24" diameters shall also meet the requirements of ASTM D2665 and shall be dual marked as such. Each production run of pipe manufactured in compliance to the standard shall also meet or exceed the test requirements for materials, workmanship, burst pressure, flattening, and extrusion quality defined in ASTM D1785 and ASTM D2665 as applicable. All belled end pipe shall have tapered sockets to create an interference type fit, which shall meet or exceed

the dimensional requirements and the minimum socket length for pressure-type sockets as defined in ASTM D2672 Standard Specification for Joints for IPS PVC Pipe Using Solvent Cement. This pipe shall have a flame spread rating of 0-25 when tested for surface burning characteristics in accordance with ULC CAN-S102.2 Method of Test for Surface Burning Characteristics of Flooring, Floor Coverings, and Miscellaneous Materials and Assemblies or equivalent.

### Marking

Product marking shall meet the requirements of ASTM D1785 and ASTM D2665 as applicable and shall include the manufacturer's name (or the manufacturer's trademark when privately labeled), the nominal pipe size, the material designation code, the pipe schedule and pressure rating in psi for water at 73°F (23°C), the ASTM designation D1785, the ASTM designation D2665 (when dual marked), the independent laboratory's seal of approval for potable water usage, and the date and time of manufacture.

### Sample Specification

All PVC Schedule 40 pipe shall be manufactured from a Type I, Grade I, Polyvinyl Chloride (PVC) compound with a Cell Classification of 12454 per ASTM D1784. The pipe shall be manufactured in strict compliance to ASTM D1785 and D2665 (where applicable), consistently meeting or exceeding the Quality Assurance test requirements of these standards with regard to material, workmanship, burst pressure, flattening, and extrusion quality. The pipe shall be manufactured in the USA, using domestic materials, by an ISO 9001 certified manufacturer. Standard lengths of pipe sizes 6" and larger shall be beveled on each end by the pipe manufacturer. All pipe shall be stored indoors after production at the manufacturing site until shipped from factory. This pipe shall carry the National Sanitation Foundation (NSF) seal of approval for potable water applications. All pipe shall be manufactured by Georg Fischer Harvel LLC.

The pressure ratings given are for water, non-shock, at 73°F (23°C). The following temperature derating factors are to be applied to the working pressure ratings (WP) listed when operating at elevated temperatures.

Multiply the working pressure rating of the selected pipe at 73°F (23°C) by the appropriate derating factor to determine the maximum working pressure rating of the pipe at the elevated temperature chosen.

The maximum service temperature for PVC is 140°F (60°C).

Solvent cemented joints should be utilized when working at or near maximum temperatures. GF Piping Systems does not recommend the use of PVC for threaded connections at temperatures above 110°F (43°C); use flanged joints, unions, or roll grooved couplings where disassembly is necessary at elevated temperatures.

Threading of Schedule 40 PVC pipe is not a recommended practice due to insufficient wall thickness. Thread only

Schedule 80 or heavier walls. Threading requires a 50% reduction in pressure rating stated for plain end pipe at 73°F (23°C).

Chemical resistance data should be referenced for proper material selection and possible derating when working with fluids other than water.

Cell Classification 12454 = PVC Type I Grade I = PVC 1120

Pipe sizes shown are manufactured in strict compliance with ASTM D1785 and ASTM D2665 where applicable.

## **PVC Industrial Plus Pipe: Schedule 40**

### **Application**

Corrosion resistant pressure pipe, IPS sizes 1/2" through 24", for use at temperatures up to and including 140°F (60°C). Pressure rating varies with schedule, pipe size, and temperature as stated in Section 3. Pipe is also suitable for PVC plastic drain, waste, and vent (DWV) applications. Generally resistant to most acids, bases, salts, aliphatic solutions, oxidants, and halogens. Chemical resistance data is available and should be referenced for proper material selection. Pipe exhibits excellent physical properties and flammability characteristics. Typical applications include chemical processing, plating, high purity applications, potable water systems, water and waste water treatment, drainage, irrigation, agricultural, and other applications involving corrosive fluid transfer.

### **Scope**

This specification outlines minimum manufacturing requirements for polyvinyl chloride (PVC) Schedule 40 iron pipe size (IPS) pressure pipe. This pipe is intended for use in applications where the fluid conveyed does not exceed 140°F (60°C). This pipe meets or exceeds the industry standards and requirements as set forth by ASTM D1785 Standard Specification for Poly(Vinyl Chloride) (PVC) Plastic Pipe, Schedules 40, 80, and 120, ASTM D2665 Standard Specification for Poly(Vinyl Chloride) (PVC) Plastic Drain, Waste, and Vent Pipe and Fittings, NSF/ANSI Standard 61 Drinking Water System Components – Health Effects, and NSF/ANSI Standard 14 Plastics Piping System Components and Related Materials.

### **PVC Materials**

The material used in the manufacture of the pipe shall be domestically produced rigid polyvinyl chloride (PVC) compound, Type I Grade I, with a Cell Classification of 12454 as defined in ASTM D1784 – Standard Specification for Rigid Poly(Vinyl Chloride) (PVC) Compounds and Chlorinated Poly(Vinyl Chloride) (CPVC) Compounds, trade name designation H707 PVC. This compound shall be white or gray in color as specified, and shall be approved by NSF International for use with potable water (NSF Std 61).

### **Dimensions**

All sizes of PVC Schedule 40 pipe shall be manufactured in strict accordance to the requirements of ASTM D1785 for

physical dimensions and tolerances. PVC Sch 40 pipe sizes 1 1/4" through 24" diameters shall also meet the requirements of ASTM D2665 and shall be dual marked as such. Each production run of pipe manufactured in compliance to the standard shall also meet or exceed the test requirements for materials, workmanship, burst pressure, flattening, and extrusion quality defined in ASTM D1785 and ASTM D2665 as applicable. All belled end pipe shall have tapered sockets to create an interference type fit, which shall meet or exceed the dimensional requirements and the minimum socket length for pressure-type sockets as defined in ASTM D2672 Standard Specification for Joints for IPS PVC Pipe Using Solvent Cement. All PVC Schedule 40 pipe must also meet the requirements of NSF/ANSI Standard 14 and CSA Standard B137.3 Rigid polyvinyl chloride (PVC) pipe and fittings for pressure applications, and shall bear the mark of these listing agencies. This pipe shall have a flame spread rating of 0-25 when tested for surface burning characteristics in accordance with ULC CAN-S102.2 Method of Test for Surface Burning Characteristics of Flooring, Floor Coverings, and Miscellaneous Materials and Assemblies or equivalent.

### **Marking**

Product marking shall meet the requirements of ASTM D1785 and ASTM D2665 as applicable and shall include the manufacturer's name (or the manufacturer's trademark when privately labeled), the nominal pipe size, the material designation code, the pipe schedule and pressure rating in psi for water at 73°F (23°C), the ASTM designation D1785, the ASTM designation D2665 (when dual marked), the independent laboratory's seal of approval for potable water usage, and the date and time of manufacture.

### **Sample Specification**

All PVC Schedule 40 pipe shall be manufactured from a Type I, Grade I, Polyvinyl Chloride (PVC) compound with a Cell Classification of 12454 per ASTM D1784. The pipe shall be manufactured in strict compliance to ASTM D1785 and D2665 (where applicable), consistently meeting or exceeding the Quality Assurance test requirements of these standards with regard to material, workmanship, burst pressure, flattening, and extrusion quality. The pipe shall be manufactured in the USA, using domestic materials, by an ISO 9001 certified manufacturer. Standard lengths of pipe sizes 6" and larger shall be beveled on each end by the pipe manufacturer. All pipe shall be stored indoors after production at the manufacturing site until shipped from factory. This pipe shall carry the National Sanitation Foundation (NSF) seal of approval for potable water applications. All pipe shall be manufactured by Georg Fischer Harvel LLC.

The pressure ratings given are for water, non-shock, at 73°F (23°C). The following temperature derating factors are to be applied to the working pressure ratings (WP) listed when operating at elevated temperatures.

Multiply the working pressure rating of the selected pipe at 73°F (23°C) by the appropriate derating factor to determine

the maximum working pressure rating of the pipe at the elevated temperature chosen.

The maximum service temperature for PVC is 140°F (60°C).

Solvent cemented joints should be utilized when working at or near maximum temperatures. GF Piping Systems does not recommend the use of PVC for threaded connections at temperatures above 110°F (43°C); use flanged joints, unions, or roll grooved couplings where disassembly is necessary at elevated temperatures.

Threading of Schedule 40 PVC pipe is not a recommended practice due to insufficient wall thickness. Thread only Schedule 80 or heavier walls. Threading requires a 50% reduction in pressure rating stated for plain end pipe at 73°F (23°C).

Chemical resistance data should be referenced for proper material selection and possible derating when working with fluids other than water.

Cell Classification 12454 = PVC Type I Grade I = PVC 1120

Pipe sizes shown are manufactured in strict compliance with ASTM D1785 and ASTM D2665 where applicable.

## **PVC Industrial Pipe: Schedule 80**

### **Application**

Corrosion resistant pressure pipe, IPS sizes 1/2" through 12", for use at temperatures up to and including 140°F (60°C). Pressure rating varies with schedule, pipe size, and temperature as stated in Section 3. Generally resistant to most acids, bases, salts, aliphatic solutions, oxidants, and halogens. Chemical resistance data is available and should be referenced for proper material selection. Pipe exhibits excellent physical properties and flammability characteristics. Typical applications include chemical processing, plating, high purity applications, potable water systems, water and waste water treatment, drainage, irrigation, agricultural, and other applications involving corrosive fluid transfer.

### **Scope**

This specification outlines minimum manufacturing requirements for polyvinyl chloride (PVC) Schedule 80 iron pipe size (IPS) pressure pipe. This pipe is intended for use in applications where the fluid conveyed does not exceed 140°F (60°C). This pipe meets or exceeds the industry standards and requirements as set forth by ASTM D1785 Standard Specification for Poly(Vinyl Chloride) (PVC) Plastic Pipe, Schedules 40, 80, and 120, NSF/ANSI Standard 61 Drinking Water System Components – Health Effects, and NSF/ANSI Standard 14 Plastics Piping System Components and Related Materials.

### **PVC Materials**

The material used in the manufacture of the pipe shall be domestically produced rigid polyvinyl chloride (PVC) compound, Type I Grade I, with a Cell Classification of 12454

as defined in ASTM D1784 – Standard Specification for Rigid Poly(Vinyl Chloride) (PVC) Compounds and Chlorinated Poly(Vinyl Chloride) (CPVC) Compounds, trade name designation H707 PVC. This compound shall be white or gray in color as specified, and shall be approved by NSF International for use with potable water (NSF Std 61).

### **Dimensions**

All sizes of PVC Schedule 80 pipe shall be manufactured in strict accordance to the requirements of ASTM D1785 for physical dimensions and tolerances. Each production run of pipe manufactured in compliance to the standard shall also meet or exceed the test requirements for materials, workmanship, burst pressure, flattening, and extrusion quality defined in ASTM D1785. All belled end pipe shall have tapered sockets to create an interference type fit, which shall meet or exceed the dimensional requirements and the minimum socket length for pressure-type sockets as defined in ASTM D2672 Standard Specification for Joints for IPS PVC Pipe Using Solvent Cement. All PVC Schedule 80 pipe must also meet the requirements of NSF/ANSI Standard 14 and shall bear the mark of this listing agency. This pipe shall have a flame spread rating of 0-25 when tested for surface burning characteristics in accordance with ULC CAN-S102.2 Method of Test for Surface Burning Characteristics of Flooring, Floor Coverings, and Miscellaneous Materials and Assemblies or equivalent.

### **Marking**

Product marking shall meet the requirements of ASTM D1785 and shall include the manufacturer's name (or the manufacturer's trademark when privately labeled), the nominal pipe size, the material designation code, the pipe schedule and pressure rating in psi for water at 73°F (23°C), the ASTM designation D1785, the independent laboratory's seal of approval for potable water usage, and the date and time of manufacture.

### **Sample Specification**

All PVC Schedule 80 pipe shall be manufactured from a Type I, Grade I, Polyvinyl Chloride (PVC) compound with a Cell Classification of 12454 per ASTM D1784. The pipe shall be manufactured in strict compliance to ASTM D1785, consistently meeting or exceeding the Quality Assurance test requirements of these standards with regard to material, workmanship, burst pressure, flattening, and extrusion quality. The pipe shall be manufactured in the USA, using domestic materials, by an ISO 9001 certified manufacturer. Standard lengths of pipe sizes 6" and larger shall be beveled on each end by the pipe manufacturer. All pipe shall be stored indoors after production at the manufacturing site until shipped from factory. This pipe shall carry the National Sanitation Foundation (NSF) seal of approval for potable water applications. All pipe shall be manufactured by Georg Fischer Harvel LLC.

The pressure ratings given are for water, non-shock, at 73°F (23°C). The following temperature derating factors are to be

applied to the working pressure ratings (WP) listed when operating at elevated temperatures.

Multiply the working pressure rating of the selected pipe at 73°F (23°C) by the appropriate derating factor to determine the maximum working pressure rating of the pipe at the elevated temperature chosen.

The maximum service temperature for PVC is 140°F (60°C).

Solvent cemented joints should be utilized when working at or near maximum temperatures. GF Piping Systems does not recommend the use of PVC for threaded connections at temperatures above 110°F (43°C); use flanged joints, unions, or roll grooved couplings where disassembly is necessary at elevated temperatures.

Thread only Schedule 80 or heavier walls. Threading requires a 50% reduction in pressure rating stated for plain end pipe at 73°F (23°C).

Chemical resistance data should be referenced for proper material selection and possible derating when working with fluids other than water.

Cell Classification 12454 = PVC Type I Grade I = PVC 1120

Pipe sizes shown are manufactured in strict compliance with ASTM D1785.

## **PVC Industrial Plus Pipe: Schedule 80**

### **Application**

Corrosion resistant pressure pipe, IPS sizes 1/8" through 24", for use at temperatures up to and including 140°F (60°C). Pressure rating varies with schedule, pipe size, and temperature as stated in Section 3. Generally resistant to most acids, bases, salts, aliphatic solutions, oxidants, and halogens. Chemical resistance data is available and should be referenced for proper material selection. Pipe exhibits excellent physical properties and flammability characteristics. Typical applications include chemical processing, plating, high purity applications, potable water systems, water and waste water treatment, drainage, irrigation, agricultural, and other applications involving corrosive fluid transfer.

### **Scope**

This specification outlines minimum manufacturing requirements for polyvinyl chloride (PVC) Schedule 80 iron pipe size (IPS) pressure pipe. This pipe is intended for use in applications where the fluid conveyed does not exceed 140°F (60°C). This pipe meets or exceeds the industry standards and requirements as set forth by ASTM D1785 Standard Specification for Poly(Vinyl Chloride) (PVC) Plastic Pipe, Schedules 40, 80, and 120, NSF/ANSI Standard 61 Drinking Water System Components – Health Effects, and NSF/ANSI Standard 14 Plastics Piping System Components and Related Materials.

## **PVC Materials**

The material used in the manufacture of the pipe shall be domestically produced rigid polyvinyl chloride (PVC) compound, Type I Grade I, with a Cell Classification of 12454 as defined in ASTM D1784 – Standard Specification for Rigid Poly(Vinyl Chloride) (PVC) Compounds and Chlorinated Poly(Vinyl Chloride) (CPVC) Compounds, trade name designation H707 PVC. This compound shall be white or gray in color as specified, and shall be approved by NSF International for use with potable water (NSF Std 61).

## **Dimensions**

All sizes of PVC Schedule 80 pipe shall be manufactured in strict accordance to the requirements of ASTM D1785 for physical dimensions and tolerances. Each production run of pipe manufactured in compliance to the standard shall also meet or exceed the test requirements for materials, workmanship, burst pressure, flattening, and extrusion quality defined in ASTM D1785. All belled end pipe shall have tapered sockets to create an interference type fit, which shall meet or exceed the dimensional requirements and the minimum socket length for pressure-type sockets as defined in ASTM D2672 Standard Specification for Joints for IPS PVC Pipe Using Solvent Cement. All PVC Schedule 80 pipe must also meet the requirements of NSF/ANSI Standard 14 and CSA Standard B137.3 Rigid polyvinyl chloride (PVC) pipe and fittings for pressure applications, and shall bear the mark of these listing agencies. This pipe shall have a flame spread rating of 0-25 when tested for surface burning characteristics in accordance with ULC CAN-S102.2 Method of Test for Surface Burning Characteristics of Flooring, Floor Coverings, and Miscellaneous Materials and Assemblies or equivalent.

## **Marking**

Product marking shall meet the requirements of ASTM D1785 and shall include the manufacturer's name (or the manufacturer's trademark when privately labeled), the nominal pipe size, the material designation code, the pipe schedule and pressure rating in psi for water at 73°F (23°C), the ASTM designation D1785, the independent laboratory's seal of approval for potable water usage, and the date and time of manufacture.

## **Sample Specification**

All PVC Schedule 80 pipe shall be manufactured from a Type I, Grade I, Polyvinyl Chloride (PVC) compound with a Cell Classification of 12454 per ASTM D1784. The pipe shall be manufactured in strict compliance to ASTM D1785, consistently meeting or exceeding the Quality Assurance test requirements of these standards with regard to material, workmanship, burst pressure, flattening, and extrusion quality. The pipe shall be manufactured in the USA, using domestic materials, by an ISO 9001 certified manufacturer. Standard lengths of pipe sizes 6" and larger shall be beveled on each end by the pipe manufacturer. All pipe shall be stored indoors after production at the manufacturing site until shipped from factory. This pipe shall carry the National



Sanitation Foundation (NSF) seal of approval for potable water applications. All pipe shall be manufactured by Georg Fischer Harvel LLC.

The pressure ratings given are for water, non-shock, at 73°F (23°C). The following temperature derating factors are to be applied to the working pressure ratings (WP) listed when operating at elevated temperatures.

Multiply the working pressure rating of the selected pipe at 73°F (23°C) by the appropriate derating factor to determine the maximum working pressure rating of the pipe at the elevated temperature chosen.

The maximum service temperature for PVC is 140°F (60°C).

Solvent cemented joints should be utilized when working at or near maximum temperatures. GF Piping Systems does not recommend the use of PVC for threaded connections at temperatures above 110°F (43°C); use flanged joints, unions, or roll grooved couplings where disassembly is necessary at elevated temperatures.

Thread only Schedule 80 or heavier walls. Threading requires a 50% reduction in pressure rating stated for plain end pipe at 73°F (23°C).

Chemical resistance data should be referenced for proper material selection and possible derating when working with fluids other than water.

Cell Classification 12454 = PVC Type I Grade I = PVC 1120

Pipe sizes shown are manufactured in strict compliance with ASTM D1785.

## **PVC Industrial Pipe: Schedule 120**

### **Application**

Corrosion resistant pressure pipe, IPS sizes 1/2" through 8", for use at temperatures up to and including 140°F (60°C). Pressure rating varies with schedule, pipe size, and temperature as stated in Section 3. Generally resistant to most acids, bases, salts, aliphatic solutions, oxidants, and halogens. Chemical resistance data is available and should be referenced for proper material selection. Pipe exhibits excellent physical properties and flammability characteristics. Typical applications include chemical processing, plating, high purity applications, potable water systems, water and waste water treatment, and other industrial applications involving corrosive fluid transfer where high pressures are encountered. Schedule 120 heavy wall dimensions provide sufficient wall thickness suitable for many drilling, tapping, and other custom machining and fabrication operations.

### **Scope**

This specification outlines minimum manufacturing requirements for polyvinyl chloride (PVC) Schedule 120 iron pipe size (IPS) pressure pipe. This pipe is intended for use in applications where the fluid conveyed does not exceed 140°F (60°C). This pipe meets or exceeds the industry standards and requirements as set forth by ASTM D1785 Standard

Specification for Poly(Vinyl Chloride) (PVC) Plastic Pipe, Schedules 40, 80, and 120, NSF/ANSI Standard 61 Drinking Water System Components – Health Effects, and NSF/ANSI Standard 14 Plastics Piping System Components and Related Materials.

### **PVC Materials**

The material used in the manufacture of the pipe shall be domestically produced rigid polyvinyl chloride (PVC) compound, Type I Grade I, with a Cell Classification of 12454 as defined in ASTM D1784 – Standard Specification for Rigid Poly(Vinyl Chloride) (PVC) Compounds and Chlorinated Poly(Vinyl Chloride) (CPVC) Compounds, trade name designation H707 PVC. This compound shall be white or gray in color as specified, and shall be approved by NSF International for use with potable water (NSF Std 61).

### **Dimensions**

All sizes of PVC Schedule 120 pipe shall be manufactured in strict accordance to the requirements of ASTM D1785 for physical dimensions and tolerances. Each production run of pipe manufactured in compliance to the standard shall also meet or exceed the test requirements for materials, workmanship, burst pressure, flattening, and extrusion quality defined in ASTM D1785. All belled end pipe shall have tapered sockets to create an interference type fit, which shall meet or exceed the dimensional requirements and the minimum socket length for pressure-type sockets as defined in ASTM D2672 Standard Specification for Joints for IPS PVC Pipe Using Solvent Cement. All PVC Schedule 80 pipe must also meet the requirements of NSF/ANSI Standard 14 and CSA Standard B137.3 Rigid polyvinyl chloride (PVC) pipe and fittings for pressure applications, and shall bear the mark of these listing agencies. This pipe shall have a flame spread rating of 0-25 when tested for surface burning characteristics in accordance with ULC CAN-S102.2 Method of Test for Surface Burning Characteristics of Flooring, Floor Coverings, and Miscellaneous Materials and Assemblies or equivalent.

### **Marking**

Product marking shall meet the requirements of ASTM D1785 and shall include the manufacturer's name (or the manufacturer's trademark when privately labeled), the nominal pipe size, the material designation code, the pipe schedule and pressure rating in psi for water at 73°F (23°C), the ASTM designation D1785, the independent laboratory's seal of approval for potable water usage, and the date and time of manufacture.

### **Sample Specification**

All PVC Schedule 120 pipe shall be manufactured from a Type I, Grade I, Polyvinyl Chloride (PVC) compound with a Cell Classification of 12454 per ASTM D1784. The pipe shall be manufactured in strict compliance to ASTM D1785, consistently meeting or exceeding the Quality Assurance test requirements of these standards with regard to material, workmanship, burst pressure, flattening, and extrusion quality. The pipe shall be manufactured in the USA, using

domestic materials, by an ISO 9001 certified manufacturer. All pipe shall be stored indoors after production at the manufacturing site until shipped from factory. This pipe shall carry the National Sanitation Foundation (NSF) seal of approval for potable water applications. All pipe shall be manufactured by Georg Fischer Harvel LLC.

The pressure ratings given are for water, non-shock, at 73°F (23°C). The following temperature derating factors are to be applied to the working pressure ratings (WP) listed when operating at elevated temperatures.

Multiply the working pressure rating of the selected pipe at 73°F (23°C) by the appropriate derating factor to determine the maximum working pressure rating of the pipe at the elevated temperature chosen.

The maximum service temperature for PVC is 140°F (60°C).

Solvent cemented joints should be utilized when working at or near maximum temperatures. GF Piping Systems does not recommend the use of PVC for threaded connections at temperatures above 110°F (43°C); use flanged joints, unions, or roll grooved couplings where disassembly is necessary at elevated temperatures.

Threading requires a 50% reduction in pressure rating stated for plain end pipe at 73°F (23°C).

Chemical resistance data should be referenced for proper material selection and possible derating when working with fluids other than water.

Cell Classification 12454 = PVC Type I Grade I = PVC 1120

Pipe sizes shown are manufactured in strict compliance with ASTM D1785.

## **CPVC Industrial Pipe: Schedule 40 & 80**

### **Application**

Corrosion resistant pressure pipe, IPS sizes 1/4" through 24", for use at temperatures up to and including 200°F (93°C). Pressure rating varies with schedule, pipe size, and temperature as stated in Section 3. Pipe is also suitable for PVC plastic drain, waste, and vent (DWV) applications. Generally resistant to most acids, bases, salts, aliphatic solutions, oxidants, and halogens. Chemical resistance data is available and should be referenced for proper material selection. Pipe exhibits excellent physical properties and flammability characteristics. Typical applications include chemical processing, plating, high purity applications, hot and cold potable water systems, water and waste water treatment, and other industrial applications involving hot, corrosive fluid transfer.

### **Scope**

This specification outlines minimum manufacturing requirements for chlorinated polyvinyl chloride (CPVC) Schedule 40 and 80 iron pipe size (IPS) pressure pipe. This pipe is intended for use in applications where the fluid conveyed does not exceed 200°F (93°C). This pipe meets or exceeds the

industry standards and requirements as set forth by ASTM F441 Standard Specification for Chlorinated Poly(Vinyl Chloride) (CPVC) Plastic Pipe, Schedules 40 and 80, NSF/ANSI Standard 61 Drinking Water System Components – Health Effects, and NSF/ANSI Standard 14 Plastics Piping System Components and Related Materials.

### **CPVC Materials**

The material used in the manufacture of the pipe shall be domestically produced rigid chlorinated polyvinyl chloride (CPVC) compound, Type IV Grade I, with a Cell Classification of 23447 as defined in ASTM D1784 – Standard Specification for Rigid Poly(Vinyl Chloride) (PVC) Compounds and Chlorinated Poly(Vinyl Chloride) (CPVC) Compounds. This compound shall be light gray in color, and shall be approved by NSF International for use with potable water (NSF Std 61).

### **Dimensions**

All sizes of CPVC Schedule 40 and 80 pipe shall be manufactured in strict accordance to the requirements of ASTM F441 for physical dimensions and tolerances. Each production run of pipe manufactured in compliance to the standard shall also meet or exceed the test requirements for materials, workmanship, burst pressure, flattening, and extrusion quality defined in ASTM F441. All belled end pipe shall have tapered sockets to create an interference type fit, which shall meet or exceed the dimensional requirements and the minimum socket length for pressure-type sockets as defined in ASTM D2672 Standard Specification for Joints for IPS PVC Pipe Using Solvent Cement.

### **Marking**

Product marking shall meet the requirements of ASTM F441 and shall include the manufacturer's name (or the manufacturer's trademark when privately labeled), the nominal pipe size, the material designation code, the pipe schedule and pressure rating in psi for water at 73°F (23°C), the ASTM designation F441, the independent laboratory's seal of approval for potable water usage, and the date and time of manufacture. Marking shall also include the flame spread rating and smoke development rating when tested and listed for surface burning characteristics per ULC CAN-S102.2 Method of Test for Surface Burning Characteristics of Flooring, Floor Coverings, and Miscellaneous Materials and Assemblies (Flame Spread of < 25 and Smoke Development of < 50).

### **Sample Specification**

All CPVC Schedule 40 and 80 pipe shall be manufactured from a Type IV, Grade I, Chlorinated Polyvinyl Chloride (CPVC) compound with a minimum Cell Classification of 23447 per ASTM D1784. The pipe shall be manufactured in strict compliance to ASTM F441, consistently meeting or exceeding the Quality Assurance test requirements of these standards with regard to material, workmanship, burst pressure, flattening, and extrusion quality. The pipe shall be manufactured in the USA, using domestic materials, by an ISO 9001 certified manufacturer. Standard lengths of pipe sizes 6" and

larger shall be beveled on each end by the pipe manufacturer. All pipe shall be stored indoors after production at the manufacturing site until shipped from factory. This pipe shall carry the National Sanitation Foundation (NSF) seal of approval for potable water applications. The pipe shall have a Flame Spread rating of < 25 and a Smoke Development rating of < 50 when tested and listed for Surface Burning Characteristics in accordance with ULC CAN-S102.2 or equivalent. All pipe shall be manufactured by Georg Fischer Harvel LLC.

The pressure ratings given are for water, non-shock, at 73°F (23°C). The following temperature derating factors are to be applied to the working pressure ratings (WP) listed when operating at elevated temperatures.

Multiply the working pressure rating of the selected pipe at 73°F (23°C) by the appropriate derating factor to determine the maximum working pressure rating of the pipe at the elevated temperature chosen.

The maximum service temperature for CPVC is 200°F (93°C).

Solvent cemented joints should be utilized when working at or near maximum temperatures. GF Piping Systems does not recommend the use of CPVC for threaded connections at temperatures above 150°F (66°C); use flanged joints, unions, or roll grooved couplings where disassembly is necessary at elevated temperatures.

Threading of Schedule 40 CPVC pipe is not a recommended practice due to insufficient wall thickness. Thread only Schedule 80 or heavier walls. Threading requires a 50% reduction in pressure rating stated for plain end pipe at 73°F (23°C).

Chemical resistance data should be referenced for proper material selection and possible derating when working with fluids other than water.

Cell Classification 23447 = CPVC Type IV Grade I = CPVC 4120

Pipe sizes shown are manufactured in strict compliance with ASTM F441.

# Double-See®

## Vinyl Double Containment Piping System

Also check out our double contained vinyl piping system! Protect people and the environment, with the system especially designed to be fast and easy to install.



### Double-See® Benefits

- Enhance safety by protecting people and the environment from potential leaks
- Eliminate potential downtime at production facilities
- Installation is fast and easy due to unique design features and preassembled components
- Flexible choice of PVC, Corzan® CPVC, and Clear PVC
- Easy to install leak detection cables due to centralizer design
- Allows true, practical compliance with ASME B31.3 during installation
- Performance - patented fitting centralizer design compensates for some thermal expansion and contraction
- Fully pressure rated valve-in-valve completes the system



# Vinyl Catalog

Schedule 80 PVC  
Schedule 40 PVC  
ChlorFIT® Schedule 80 CPVC  
Schedule 40 PVC  
Speciality Pipe  
Extruded Shapes and Rods  
Joining Accessories  
PVC Metric



# Table of contents

---

Schedule 80 PVC Piping System	107
Schedule 40 and ChlorFIT® Schedule 80 CPVC Piping Systems	141
Schedule 40 PVC Piping System	175
Specialty Pipe	199
Extruded Shapes and Rods	209
Joining Accessories	221
PVC Metric	225

---



Section 1

# Schedule 80 PVC Piping Systems

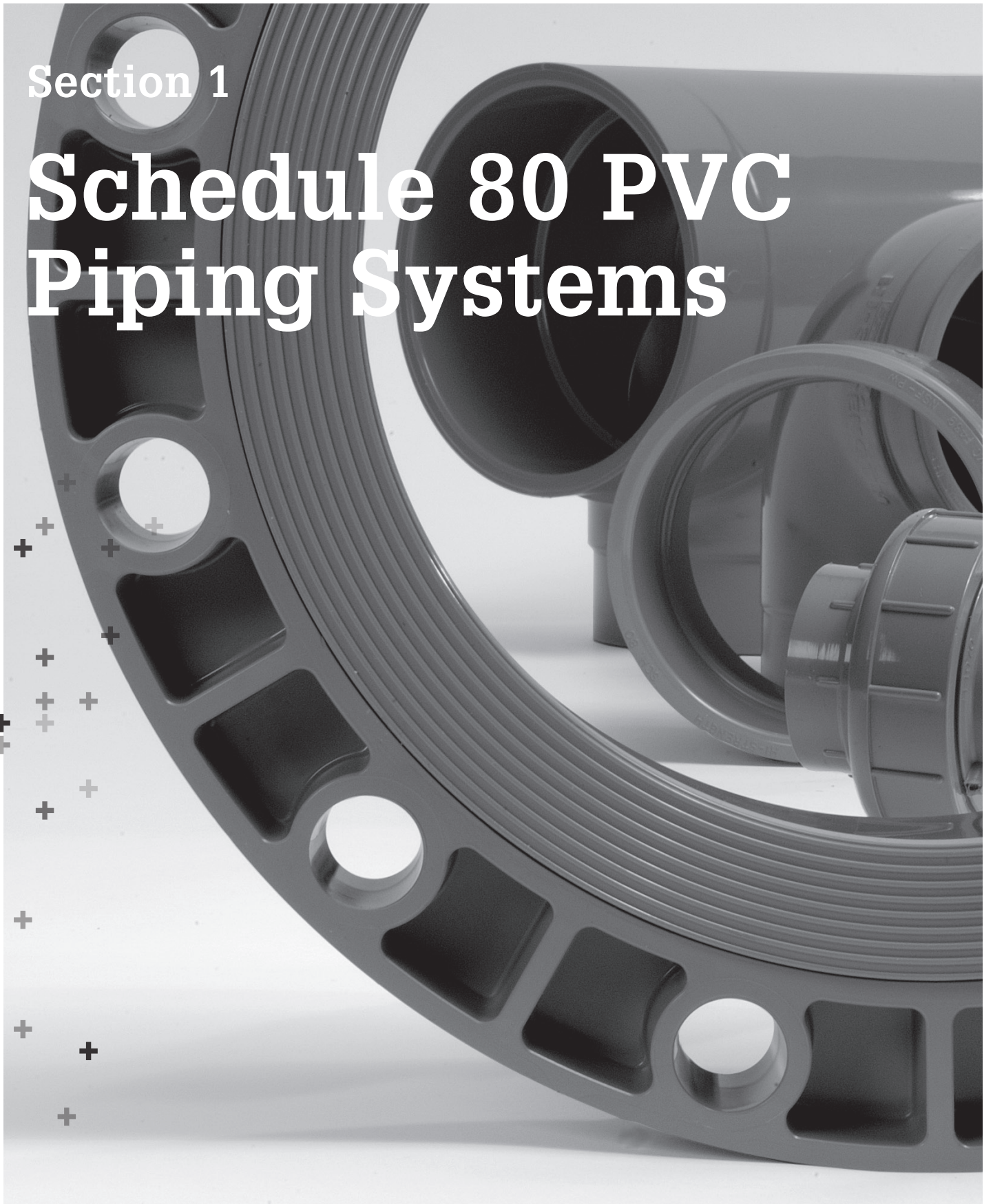

## Glossary

<b>FPT</b>	=	<b>Female Pipe Thread</b>
<b>MPT</b>	=	<b>Male Pipe Thread</b>
<b>S</b>	=	<b>Tapered Socket</b>
<b>SPG</b>	=	<b>Spigot End (same dimension as pipe outside diameter)</b>
<b>*</b>	=	<b>Non-Returnable / Non-cancellable</b>
<b>^</b>	=	<b>40% Restocking Fee</b>
<b>HS</b>	=	<b>High Strength Design</b>
<b>SL</b>	=	<b>Streamline Design</b>
<b>BUSH</b>	=	<b>Assembled Fitting from Molded Components</b>
<b>FAB</b>	=	<b>Fabricated Fitting</b>

The technical information given in this publication implies no warranty of any kind and is subject to change without notice. Please consult our Terms and Conditions of Sale.

For complete technical information, please consult the Vinyl Catalog and Technical Information

**For more information about any of our product lines, please visit [www.gfps.com](http://www.gfps.com)**



Harvel® Industrial PVC Pressure Pipe

111

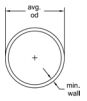

Harvel® Industrial PLUS PVC Pressure Pipe

112



Schedule 80 PVC Pressure Fittings

113



Schedule 80 PVC Low Pressure Fittings

133



Schedule 80 PVC DWV Fittings

135

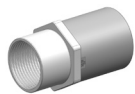

Schedule 80 PVC Metal Transition Fittings

138



Schedule 80 PVC Expansion Joints

140



# Specifications, Standards and Tolerances

## Specifications and Standards

NSF/ANSI Standard 14

NSF/ANSI Standard 61

ASTM D 1784	:	Material PVC Type I, Grade I Gray (cell classification 12454)
ASTM D 1785	:	PVC Schedule 80 Pipe
ASTM D 2467	:	PVC Schedule 80 Socket & Threaded Fittings
ASTM D 2464	:	PVC Schedule 80 Threaded Fittings
ASTM F 1498	:	PVC Schedule 80 Taper Threads
ASTM D 2672	:	PVC Schedule 80 Tapered Sockets for Bell End Pipe
ASTM F 1970	:	PVC Schedule 80 Unions
ANSI B16.5	:	Outside Diameter & Flange Bolt Hole Patterns
ANSI B1.20.1	:	PVC Schedule 80 NPT Threads
CSA B137.3	:	PVC Schedule 80 Pipe

## Molded Dimension Tolerances

A	Piston Position; Expansion Joints : $\pm 0.03$
D	Outside Diameter : $\pm 0.06$
G, G1	Intersections of centerlines to bottom of socket; 90° Ells, Tees : up to 4" $\pm 0.03$ ; 6" and above $\pm 0.06$
GJ, GN	Intersections of centerlines to bottom of socket; 45° Wyes : up to 4" $\pm 0.03$ ; 6" and above $\pm 0.06$
H, HJ, HN	Intersections of centerlines to face of fitting; 90° Ells, 45° Ells, Tees, 45° Wyes : up to 4" $\pm 0.03$ ; 6" and above $\pm 0.06$
HL	Socket Bottom to Face of Fitting : up to 4" $\pm 0.03$ ; 6" and above $\pm 0.06$
J	Intersections of centerlines to bottom of socket; 45° & 30° Ells : up to 4" $\pm 0.03$ ; 6" and above $\pm 0.06$
L	Overall Length of fitting : $\pm 0.06$
N	Socket Bottom to Socket Bottom; Couplings, Unions : $\pm 0.06$
N1	Socket Bottom to Face of Flange : $\pm 0.06$
R	Thickness on Plugs, Flanges : $\pm 0.03$
T, T1	Effective Thread Length : Reference Only
W	Height of Cap : $\pm 0.06$

# Harvel® Industrial PVC Pressure Pipe

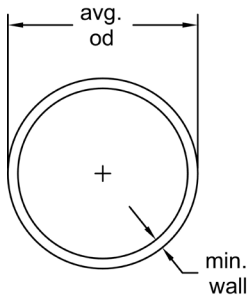

## Plain End Pipe - 20 ft lengths

- Refer to Industrial PLUS for sizes 1/8", 1/4", 3/8", 3-1/2", 5", 14"-24"
- Max Water Pressure at 73°F (22.7°C) with solvent-cemented joints
- Meets NSF<sup>®</sup>-pw-G
- Non - CSA Approved

Size (inch)	P/L	Plain End Part No.	Lift Qty. (20ft Lgths) (ft)	Average O.D. (inch)	Min. Wall (inch)	Wt/Ft (lbs/ft)	Max Water Pressure (psi)
1/2	H18	<b>H0800050PG2000</b>	5700	0.840	0.147	0.202	850
3/4	H18	<b>H0800075PG2000</b>	5260	1.050	0.154	0.273	690
1	H18	<b>H0800100PG2000</b>	4280	1.315	0.179	0.402	630
1 1/4	H18	<b>H0800125PG2000</b>	2360	1.660	0.191	0.554	520
1 1/2	H18	<b>H0800150PG2000</b>	2060	1.900	0.200	0.673	470
2	H18	<b>H0800200PG2000</b>	1660	2.375	0.218	0.932	400
2 1/2	H18	<b>H0800250PG2000</b>	1080	2.875	0.276	1.419	420
3	H18	<b>H0800300PG2000</b>	840	3.500	0.300	1.903	370
4	H18	<b>H0800400PG2000</b>	520	4.500	0.337	2.782	320
6	H18	<b>H0800600PG2000</b>	340	6.625	0.432	5.313	280
8	H18	<b>H0800800PG2000</b>	220	8.625	0.500	8.058	250
10	H18	<b>H0801000PG2000</b>	80	10.750	0.593	11.956	230
12	H18	<b>H0801200PG2000</b>	60	12.750	0.687	16.437	230

## Belled End Pipe - 20 ft length Less Bell

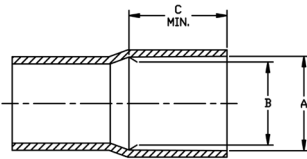

Size (inch)	P/L	Belled End Part No.	A-Socket Entrance (Belled Pipe)	B-Socket Bottom (Belled Pipe)	C-Min. (Belled Pipe)
1/2	H18	<b>H0800050PG200B</b>	0.848±0.004	0.836±0.004	1.000
3/4	H18	<b>H0800075PG200B</b>	1.058±0.004	1.046±0.004	1.250
1	H18	<b>H0800100PG200B</b>	1.325±0.005	1.310±0.005	1.500
1 1/4	H18	<b>H0800125PG200B</b>	1.678±0.002	1.653±0.005	1.870
1 1/2	H18	<b>H0800150PG200B</b>	1.910±0.004	1.884±0.004	2.000
2	H18	<b>H0800200PG200B</b>	2.387±0.006	2.369±0.006	2.250
2 1/2	H18	<b>H0800250PG200B</b>	2.889±0.007	2.868±0.007	2.500
3	H18	<b>H0800300PG200B</b>	3.516±0.008	3.492±0.008	3.250
4	H18	<b>H0800400PG200B</b>	4.518±0.009	4.491±0.009	4.000
6	H18	<b>H0800600PG200B</b>	6.647±0.011	6.614±0.011	6.000
8	H18	<b>H0800800PG200B</b>	8.655±0.015	8.610±0.015	6.000
10	H18	<b>H0801000PG200B</b>	10.776±0.015	10.737±0.015	8.000
12	H18	<b>H0801200PG200B</b>	12.778±0.015	12.736±0.015	8.500

# Harvel® Industrial PLUS PVC Pressure Pipe

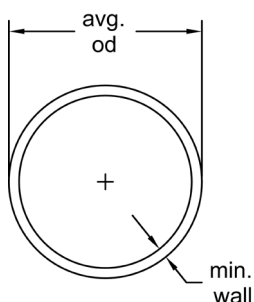

## Plain End Pipe - 20 ft lengths

- Meets NSF®-pw-G
- Meets CAN/CSA B137.3 Requirements

Size (inch)	P/L	Plain End Part No.	Lift Qty. (20ft Lgths) (ft)	Average O.D. (inch)	Min. Wall (inch)	Wt/Ft (lbs/ft)	Max Water Pressure (psi)
¼	H50	<b>H0800013PG2000</b>	5700	0.405	0.095	0.058	1230
¼	H50	<b>H0800025PG2000</b>	5700	0.540	0.119	0.100	1130
¾	H50	<b>H0800038PG2000</b>	5700	0.675	0.126	0.138	920
½	H50	<b>HX800050PG2000</b>	5700	0.840	0.147	0.202	850
¾	H50	<b>HX800075PG2000</b>	5260	1.050	0.154	0.273	690
1	H50	<b>HX800100PG2000</b>	4280	1.315	0.179	0.402	630
1 ¼	H50	<b>HX800125PG2000</b>	2360	1.660	0.191	0.554	520
1 ½	H50	<b>HX800150PG2000</b>	2060	1.900	0.200	0.673	470
2	H50	<b>HX800200PG2000</b>	1660	2.375	0.218	0.932	400
2 ½	H50	<b>HX800250PG2000</b>	1080	0.287	0.276	1.419	420
3	H50	<b>HX800300PG2000</b>	840	3.500	0.300	1.903	370
3 ½	H50	<b>H0800350PG2000</b>	680	4.000	0.318	2.322	350
4	H50	<b>HX800400PG2000</b>	520	4.500	0.337	2.782	320
5	H50	<b>H0800500PG2000</b>	400	5.563	0.375	3.867	290
6	H50	<b>HX800600PG2000</b>	340	6.625	0.432	5.313	280
8	H50	<b>HX800800PG2000</b>	220	8.625	0.500	8.058	250
10	H50	<b>HX801000PG2000</b>	80	10.750	0.593	11.956	230
12	H50	<b>HX801200PG2000</b>	60	12.750	0.687	16.437	230
14	H50	<b>H0801400PG2000</b>	60	14.000	0.750	19.790	220
16	H50	<b>H0801600PG2000</b>	60	16.000	0.843	25.430	220
18	H50	<b>H0801800PG2000</b>	40	18.000	0.937	31.830	220
20	H50	<b>H0802000PG2000</b>	40	20.000	1.031	40.091	220
24	H50	<b>H0802400PG2000</b>	40	24.000	1.218	56.882	210

## Belled End Pipe - 20 ft length Less Bell

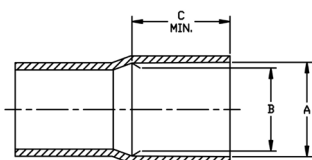

Size (inch)	P/L	Belled End Part No.	A-Socket Entrance (Belled Pipe)	B-Socket Bottom (Belled Pipe)	C-Min. (Belled Pipe)
½	H50	<b>HX800050PG200B</b>	0.848±0.004	0.836±0.004	1.000
¾	H50	<b>HX800075PG200B</b>	1.058±0.004	1.046±0.004	1.250
1	H50	<b>HX800100PG200B</b>	1.325±0.005	1.310±0.005	1.500
1 ¼	H50	<b>HX800125PG200B</b>	1.670±0.005	1.655±0.005	1.750
1 ½	H50	<b>HX800150PG200B</b>	1.912±0.006	1.894±0.006	2.000
2	H50	<b>HX800200PG200B</b>	2.387±0.006	2.363±0.006	2.250
2 ½	H50	<b>HX800250PG200B</b>	2.889±0.007	2.861±0.007	2.500
3	H50	<b>HX800300PG200B</b>	3.516±0.008	3.484±0.008	3.250
3 ½	H50	<b>H0800350PG200B</b>	4.016±0.008	3.984±0.008	3.500
4	H50	<b>HX800400PG200B</b>	4.518±0.009	4.482±0.009	4.000
5	H50	<b>H0800500PG200B</b>	5.583±0.010	5.543±0.010	4.000
6	H50	<b>HX800600PG200B</b>	6.647±0.011	6.603±0.011	6.000
8	H50	<b>HX800800PG200B</b>	8.655±0.015	8.598±0.015	6.000
10	H50	<b>HX801000PG200B</b>	10.776±0.015	10.722±0.015	7.500
12	H50	<b>HX801200PG200B</b>	12.778±0.015	12.721±0.015	8.500
14	H50	<b>H0801400PG200B</b>	14.035±0.015	13.985±0.015	9.000
16	H50	<b>H0801600PG200B</b>	16.045±0.015	15.980±0.015	10.000
18	H50	<b>H0801800PG200B</b>	18.055±0.020	17.980±0.020	12.000
20	H50	<b>H0802000PG200B</b>	20.065±0.025	19.980±0.025	12.000
24	H50	<b>H0802400PG200B</b>	24.075±0.030	23.970±0.030	12.000

# Schedule 80 PVC Pressure Fittings

## Tee (S x S x S) Schedule 80 Harvel® PVC

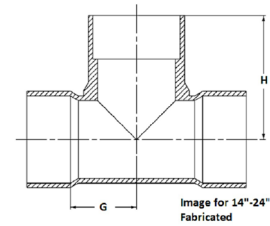
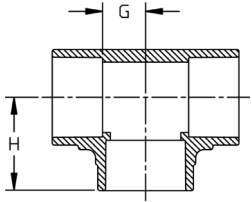
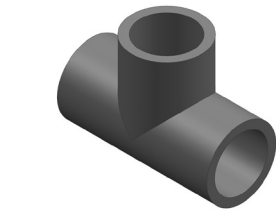

Size (inch)	P/L	Part No.	Pack Qty	H (inch)	G (inch)	Design
¼	608	801-002	50	0.95	0.27	HS
⅜	608	801-003	50	1.16	0.38	HS
½	608	801-005	25	1.41	0.51	SL
¾	608	801-007	25	1.60	0.58	SL
1	608	801-010	20	1.85	0.71	SL
1 ¼	608	801-012	10	2.17	0.91	SL
1 ½	608	801-015	10	2.43	1.04	SL
2	608	801-020	10	2.81	1.30	SL
2 ½	608	801-025	5	3.31	1.55	SL
3	608	801-030	5	3.71	1.81	SL
4	608	801-040	5	4.60	2.33	SL
6	608	801-060	2	6.53	3.51	SL
8	608	801-080	1	8.66	4.58	SL
10	602	801-100	1	10.79	5.78	SL
12	602	801-120	1	12.96	6.94	SL
14	A33	801-140N	1	19.50	10.88	FAB
16	A33	801-160N	1	22.75	12.13	FAB
18	A33	801-180N	1	26.00	13.38	FAB
20	A33	801-200N	1	28.25	14.63	FAB
24	A33	801-240N	1	34.50	17.13	FAB

## Reducing Tee (S x S x S) Schedule 80 Harvel® PVC

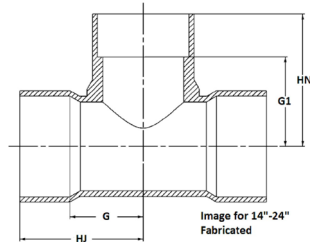
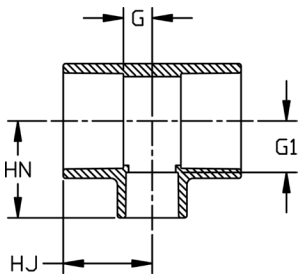
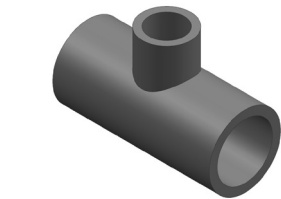

Size (inch)	P/L	Part No.	Pack Qty	HJ (inch)	HN (inch)	G (inch)	G1 (inch)	Design
¾ x ½	608	801-101	25	1.62	1.62	0.60	0.72	SL
1 x ½	608	801-130	25	1.87	1.64	0.72	0.74	SL
1 x ¾	608	801-131	20	1.86	1.89	0.72	0.75	SL
1 ¼ x ½	608	801-166FB	20	1.99	2.35	0.73	1.47	BUSH
1 ¼ x ¾	608	801-167FB	20	1.99	2.35	0.73	1.33	BUSH
1 ¼ x 1	608	801-168	20	2.01	2.05	0.73	0.91	SL
1 ½ x ½	608	801-209	5	1.92	1.91	0.53	1.03	SL
1 ½ x ¾	608	801-210	5	1.99	2.07	0.60	1.05	SL
1 ½ x 1	608	801-211	5	2.12	2.17	0.72	1.03	SL
1 ½ x 1 ¼	608	801-212FB	5	2.44	2.74	1.04	1.47	BUSH
2 x ½	608	801-247	5	1.99	2.16	0.54	1.28	SL
2 x ¾	608	801-248	5	2.22	2.31	0.60	1.30	SL
2 x 1	608	801-249	5	2.24	2.42	0.72	1.27	SL
2 x 1 ¼	608	801-250FB	5	2.81	3.11	1.30	1.84	BUSH
2 x 1 ½	608	801-251	5	2.54	2.66	1.03	1.27	SL
2 ½ x ½	608	801-287FB	5	3.05	3.35	1.28	2.44	BUSH
2 ½ x ¾	608	801-288FB	5	3.05	3.35	1.28	2.33	BUSH
2 ½ x 1	608	801-289FB	5	3.05	3.36	1.28	2.22	BUSH
2 ½ x 1 ¼	608	801-290FB	5	3.05	3.34	1.28	2.07	BUSH
2 ½ x 1 ½	608	801-291FB	5	3.05	3.35	1.28	1.94	BUSH
2 ½ x 2	608	801-292	5	3.05	3.05	1.28	1.54	SL
3 x ½	608	801-333FB	5	3.20	3.68	1.30	2.77	BUSH
3 x ¾	608	801-334FB	5	3.20	3.68	1.30	2.66	BUSH
3 x 1	608	801-335FB	5	3.20	3.69	1.30	2.55	BUSH
3 x 1 ¼	608	801-336FB	5	3.20	3.67	1.30	2.40	BUSH
3 x 1 ½	608	801-337FB	5	3.20	3.68	1.30	2.27	BUSH
3 x 2	608	801-338	5	3.20	3.39	1.30	1.87	SL
3 x 2 ½	608	801-339FB	5	3.73	4.07	1.81	2.17	BUSH
4 x ½	608	801-415FB	5	3.52	4.19	1.27	3.28	BUSH
4 x ¾	608	801-416FB	5	3.52	4.19	1.27	3.17	BUSH

table continued on the next page

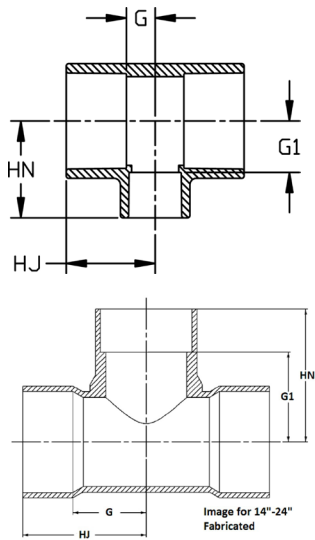

Size (inch)	P/L	Part No.	Pack Qty	HJ (inch)	HN (inch)	G (inch)	G1 (inch)	Design
4 x 1	608	<b>801-417</b>	5	2.99	3.49	0.74	2.36	SL
4 x 1 ¼	608	<b>801-418FB</b>	5	3.52	4.18	1.27	2.91	BUSH
4 x 1 ½	608	<b>801-419FB</b>	5	3.52	4.19	1.27	2.78	BUSH
4 x 2	608	<b>801-420</b>	5	3.54	3.87	1.27	2.37	SL
4 x 2 ½	608	<b>801-421FB</b>	5	4.14	4.62	1.85	2.73	BUSH
4 x 3	608	<b>801-422</b>	5	4.13	4.26	1.85	2.35	SL
6 x ½	608	<b>801-523FB</b>	2	6.56	7.42	3.56	6.52	BUSH
6 x ¾	608	<b>801-524FB</b>	2	6.56	7.43	3.49	6.41	BUSH
6 x 1	608	<b>801-525FB</b>	2	6.56	7.44	3.49	6.29	BUSH
6 x 1 ¼	608	<b>801-526FB</b>	2	6.56	7.42	3.49	6.15	BUSH
6 x 1 ½	608	<b>801-527FB</b>	2	6.56	7.42	3.49	6.02	BUSH
6 x 2	608	<b>801-528</b>	2	4.45	5.25	1.43	3.74	SL
6 x 2 ½	608	<b>801-529FB</b>	2	6.56	7.52	3.49	5.62	BUSH
6 x 3	608	<b>801-530FB</b>	2	6.56	7.21	3.49	5.25	BUSH
6 x 4	608	<b>801-532</b>	2	6.57	6.80	3.49	4.47	HS
6 x 5	H04	<b>801-533FS</b>	1	9.00	9.50	5.75	6.50	FAB
8 x 4	608	<b>801-582</b>	2	8.41	8.53	4.29	6.30	SL
8 x 6	608	<b>801-585</b>	1	7.65	7.54	3.55	4.63	SL
10 x 1 ½	A33	<b>801-618N</b>	1	10.75	12.45	5.75	11.04	FAB
10 x 2	A33	<b>801-619N</b>	1	10.75	11.50	5.75	9.50	FAB
10 x 3	A33	<b>801-621N</b>	1	10.75	11.50	5.25	9.50	FAB
10 x 4	A33	<b>801-623N</b>	1	10.75	11.50	5.75	9.50	FAB
10 x 6	602	<b>801-626FB</b>	1	10.83	11.43	5.78	8.33	BUSH
10 x 6	A33	<b>801-626N</b>	1	11.88	12.50	6.88	9.50	FAB
10 x 8	602	<b>801-628FB</b>	1	10.83	11.46	5.78	7.36	BUSH
10 x 8	A33	<b>801-628N</b>	1	13.00	13.50	8.00	9.50	FAB
12 x 2	A33	<b>801-659N</b>	1	12.00	12.75	6.00	10.75	FAB
12 x 3	A33	<b>801-661N</b>	1	12.00	12.75	6.00	10.75	FAB
12 x 4	A33	<b>801-663N</b>	1	12.00	12.75	6.00	10.75	FAB
12 x 6	A33	<b>801-666N</b>	1	13.13	13.75	7.13	10.75	FAB
12 x 8	602	<b>801-668FB</b>	1	12.99	13.67	6.94	9.58	BUSH
12 x 8	A33	<b>801-668N</b>	1	14.13	14.75	8.13	10.75	FAB
12 x 10	602	<b>801-670FB</b>	1	12.99	13.68	6.94	8.57	BUSH
12 x 10	A33	<b>801-670N</b>	1	15.13	15.75	9.13	10.75	FAB
14 x 2	A33	<b>801-692N</b>	1	13.13	13.50	6.13	11.50	FAB
14 x 3	A33	<b>801-694N</b>	1	12.63	13.50	6.13	11.50	FAB
14 x 4	A33	<b>801-696N</b>	1	13.13	13.50	6.13	11.50	FAB
14 x 6	A33	<b>801-698N</b>	1	14.25	14.50	7.25	11.50	FAB
14 x 8	A33	<b>801-700N</b>	1	15.25	15.50	8.25	11.50	FAB
14 x 10	A33	<b>801-702N</b>	1	16.25	16.50	9.25	11.50	FAB
14 x 12	A33	<b>801-704N</b>	1	17.25	18.50	10.25	12.50	FAB
16 x 2	A33	<b>801-726N</b>	1	14.38	14.75	6.38	12.75	FAB
16 x 3	A33	<b>801-728N</b>	1	14.38	14.75	6.38	12.75	FAB
16 x 4	A33	<b>801-730N</b>	1	14.38	14.75	6.38	12.75	FAB
16 x 6	A33	<b>801-732N</b>	1	15.50	15.75	7.50	12.75	FAB
16 x 8	A33	<b>801-734N</b>	1	16.50	16.75	8.50	12.75	FAB
16 x 10	A33	<b>801-736N</b>	1	17.50	17.75	9.50	12.75	FAB
16 x 12	A33	<b>801-738N</b>	1	18.50	19.75	10.50	13.75	FAB
16 x 14	A33	<b>801-740N</b>	1	19.13	20.75	11.13	13.75	FAB
18 x 4	A33	<b>801-784N</b>	1	15.63	16.00	6.63	14.00	FAB
18 x 6	A33	<b>801-786N</b>	1	16.75	17.00	7.75	14.00	FAB
18 x 8	A33	<b>801-788N</b>	1	17.75	18.00	8.75	14.00	FAB
18 x 10	A33	<b>801-790N</b>	1	18.75	19.00	9.75	14.00	FAB
18 x 12	A33	<b>801-792N</b>	1	19.75	21.00	10.75	15.00	FAB
18 x 14	A33	<b>801-794N</b>	1	20.38	22.00	11.38	15.00	FAB
18 x 16	A33	<b>801-796N</b>	1	21.38	24.00	12.38	16.00	FAB
20 x 4	A33	<b>801-814N</b>	1	16.88	17.25	6.88	15.25	FAB
20 x 6	A33	<b>801-816N</b>	1	18.00	18.25	8.00	15.25	FAB
20 x 8	A33	<b>801-818N</b>	1	19.00	19.25	9.00	15.25	FAB
20 x 10	A33	<b>801-820N</b>	1	20.00	20.25	10.00	15.25	FAB
20 x 12	A33	<b>801-822N</b>	1	21.00	22.25	11.00	16.25	FAB
20 x 14	A33	<b>801-824N</b>	1	21.63	23.25	11.63	16.25	FAB
20 x 16	A33	<b>801-826N</b>	1	22.63	25.25	12.63	17.25	FAB

table continued on the next page



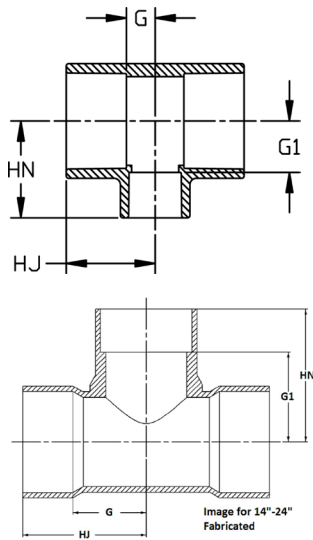

Size (inch)	P/L	Part No.	Pack Qty	HJ (inch)	HN (inch)	G (inch)	G1 (inch)	Design
20 x 18	A33	<b>801-828N</b>	1	23.63	27.25	13.63	18.25	FAB
24 x 4	A33	<b>801-904N</b>	1	19.38	19.50	7.38	17.50	FAB
24 x 6	A33	<b>801-906N</b>	1	20.50	20.50	8.50	17.50	FAB
24 x 8	A33	<b>801-908N</b>	1	21.50	21.50	9.50	17.50	FAB
24 x 10	A33	<b>801-910N</b>	1	22.50	22.50	10.50	17.50	FAB
24 x 12	A33	<b>801-912N</b>	1	23.50	24.50	11.50	18.50	FAB
24 x 14	A33	<b>801-914N</b>	1	24.13	25.50	12.13	18.50	FAB
24 x 16	A33	<b>801-916N</b>	1	25.13	27.50	13.13	19.50	FAB
24 x 18	A33	<b>801-918N</b>	1	26.13	30.50	14.13	20.50	FAB
24 x 20	A33	<b>801-920N</b>	1	27.13	32.50	15.13	20.50	FAB

### Tee (S x S x FPT) Schedule 80 Harvel® PVC

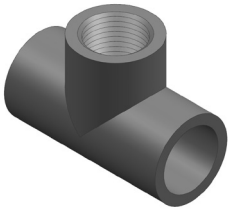

Size (inch)	P/L	Part No.	Pack Qty	HJ (inch)	HN (inch)	G (inch)	T (inch)	Design
½	608	<b>802-005</b>	25	1.41	1.30	0.53	0.81	HS
¾	608	<b>802-007</b>	25	1.60	1.37	0.60	0.71	HS
1	608	<b>802-010</b>	15	1.83	1.73	0.69	0.99	HS
1 ½	608	<b>802-015</b>	5	2.41	2.08	1.02	1.04	HS
2	608	<b>802-020</b>	5	2.79	2.37	1.29	1.08	HS

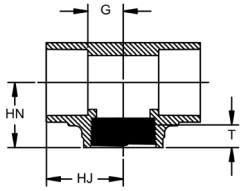

### Tee (FPT x FPT x FPT) Schedule 80 Harvel® PVC

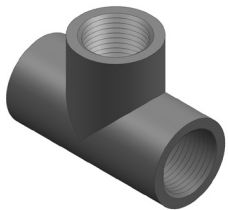

Size (inch)	P/L	Part No.	Pack Qty	H (inch)	T (inch)	Design
¼	608	<b>805-002</b>	50	0.94	0.59	HS
⅜	608	<b>805-003</b>	50	1.01	0.60	HS
½	608	<b>805-005</b>	25	1.26	0.76	HS
¾	608	<b>805-007</b>	25	1.36	0.72	HS
1	608	<b>805-010</b>	15	1.79	0.99	HS
1 ¼	608	<b>805-012</b>	10	1.93	1.01	HS
1 ½	608	<b>805-015</b>	5	2.08	1.03	HS
2	608	<b>805-020</b>	5	2.39	1.06	HS
2 ½	608	<b>805-025</b>	5	2.87	1.35	HS
3	608	<b>805-030</b>	5	3.52	1.65	HS
4	608	<b>805-040</b>	5	4.07	1.72	HS

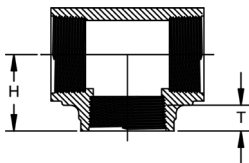

90° Ell (S x S) Schedule 80 Harvel® PVC

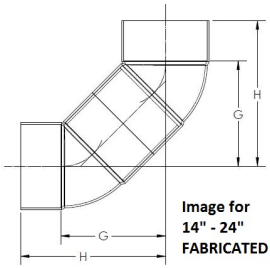
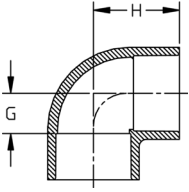
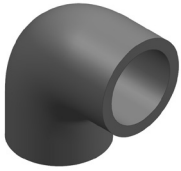

Size (inch)	P/L	Part No.	Pack Qty	H (inch)	G (inch)	Design
¼	608	<b>806-002</b>	50	0.96	0.35	HS
⅜	608	<b>806-003</b>	50	1.15	0.39	HS
½	608	<b>806-005</b>	25	1.41	0.51	SL
¾	608	<b>806-007</b>	25	1.60	0.57	SL
1	608	<b>806-010</b>	10	1.83	0.68	SL
1 ¼	608	<b>806-012</b>	10	2.18	0.90	SL
1 ½	608	<b>806-015</b>	10	2.43	1.04	SL
2	608	<b>806-020</b>	20	2.80	1.27	SL
2 ½	608	<b>806-025</b>	5	3.33	1.53	SL
3	608	<b>806-030</b>	5	3.73	1.81	SL
4	608	<b>806-040</b>	5	4.63	2.32	SL
6	608	<b>806-060</b>	2	6.56	3.53	SL
8	608	<b>806-080</b>	1	8.68	4.55	SL
10	602	<b>806-100</b>	1	10.79	5.77	SL
12	602	<b>806-120</b>	1	12.92	6.87	SL
14	A33	<b>806-140N</b>	1	26.00	19.00	FAB
16	A33	<b>806-160N</b>	1	29.00	21.75	FAB
18	A33	<b>806-180N</b>	1	33.50	24.50	FAB
20	A33	<b>806-200N</b>	1	37.25	27.25	FAB
24	A33	<b>806-240N</b>	1	44.75	31.00	FAB

90° Ell (S x FPT) Schedule 80 Harvel® PVC

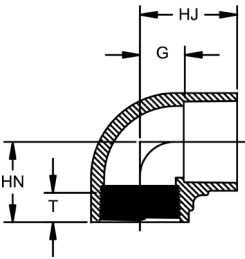
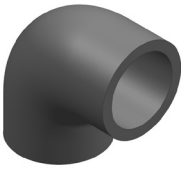

Size (inch)	P/L	Part No.	Pack Qty	HJ (inch)	HN (inch)	G (inch)	T (inch)	Design
¼	608	<b>807-005</b>	25	1.40	1.31	0.50	0.81	HS
⅜	608	<b>807-007</b>	25	1.59	1.36	0.58	0.72	HS
1	608	<b>807-010</b>	10	1.81	1.70	0.67	1.00	HS
1 ¼	608	<b>807-012</b>	10	2.15	1.92	0.90	1.03	HS
1 ½	608	<b>807-015</b>	10	2.39	2.05	1.01	1.05	HS
2	608	<b>807-020</b>	5	2.77	2.36	1.24	1.09	HS
3	608	<b>807-030</b>	5	3.73	3.47	1.83	1.66	HS

### 90° Ell (FPT x FPT) Schedule 80 Harvel® PVC

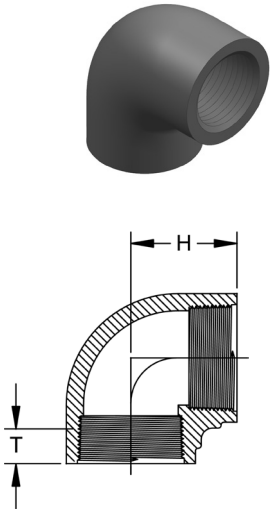

Size (inch)	P/L	Part No.	Pack Qty	H (inch)	T (inch)	Design
¼	608	<b>808-002</b>	50	0.94	0.61	HS
⅜	608	<b>808-003</b>	50	1.00	0.63	HS
½	608	<b>808-005</b>	25	1.27	0.78	HS
¾	608	<b>808-007</b>	25	1.36	0.72	HS
1	608	<b>808-010</b>	10	1.71	1.00	HS
1 ¼	608	<b>808-012</b>	10	1.92	1.01	HS
1 ½	608	<b>808-015</b>	10	2.08	1.06	HS
2	608	<b>808-020</b>	5	2.36	1.08	HS
2 ½	608	<b>808-025</b>	5	3.36	1.51	HS
3	608	<b>808-030</b>	5	3.53	1.63	HS
4	608	<b>808-040</b>	5	4.17	1.75	HS

### 45° Ell (S x S) Schedule 80 Harvel® PVC

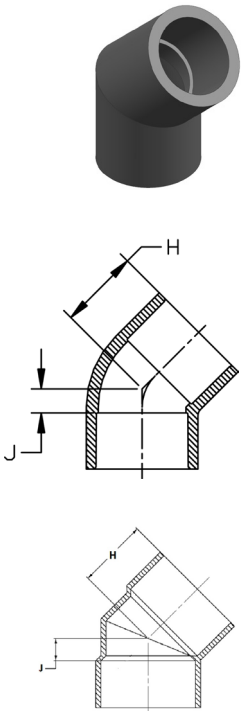

Size (inch)	P/L	Part No.	Pack Qty	H (inch)	J (inch)	Design
¼	608	<b>817-002</b>	50	0.81	0.18	HS
⅜	608	<b>817-003</b>	50	0.94	0.19	HS
½	608	<b>817-005</b>	25	1.22	0.30	SL
¾	608	<b>817-007</b>	20	1.29	0.28	SL
1	608	<b>817-010</b>	25	1.48	0.32	SL
1 ¼	608	<b>817-012</b>	15	1.78	0.47	SL
1 ½	608	<b>817-015</b>	10	1.88	0.45	SL
2	608	<b>817-020</b>	5	2.16	0.60	SL
2 ½	608	<b>817-025</b>	5	2.56	0.79	SL
3	608	<b>817-030</b>	5	2.67	0.77	SL
4	608	<b>817-040</b>	5	3.31	1.04	SL
6	608	<b>817-060</b>	2	4.86	1.77	SL
8	608	<b>817-080</b>	2	6.15	2.07	SL
10	602	<b>817-100</b>	1	7.51	2.46	SL
12	602	<b>817-120</b>	1	9.00	2.96	SL
14	A33	<b>817-140N</b>	1	10.25	3.50	FAB
16	A33	<b>817-160N</b>	1	11.75	3.75	FAB
18	A33	<b>817-180N</b>	1	13.25	4.25	FAB
20	A33	<b>817-200N</b>	1	14.75	4.75	FAB
24	A33	<b>817-240N</b>	1	17.75	5.75	FAB

Image for 14"-24"  
Fabricated

**45° Ell (FPT x FPT) Schedule 80 Harvel® PVC**

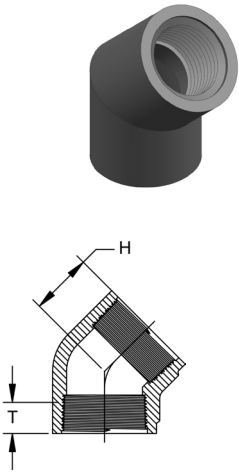

Size (inch)	P/L	Part No.	Pack Qty	H (inch)	T (inch)	Design
¼	608	<b>819-002</b>	50	0.69	0.59	HS
⅜	608	<b>819-003</b>	50	0.86	0.68	HS
½	608	<b>819-005</b>	25	1.02	0.76	SL
¾	608	<b>819-007</b>	20	1.14	0.81	SL
1	608	<b>819-010</b>	25	1.33	0.97	SL
1 ¼	608	<b>819-012</b>	15	1.42	1.01	SL
1 ½	608	<b>819-015</b>	10	1.47	1.07	SL
2	608	<b>819-020</b>	5	1.74	2.37	SL
3	608	<b>819-030</b>	5	2.43	1.66	SL
4	608	<b>819-040</b>	5	2.78	1.76	SL

**Coupling (S x S) Schedule 80 Harvel® PVC**

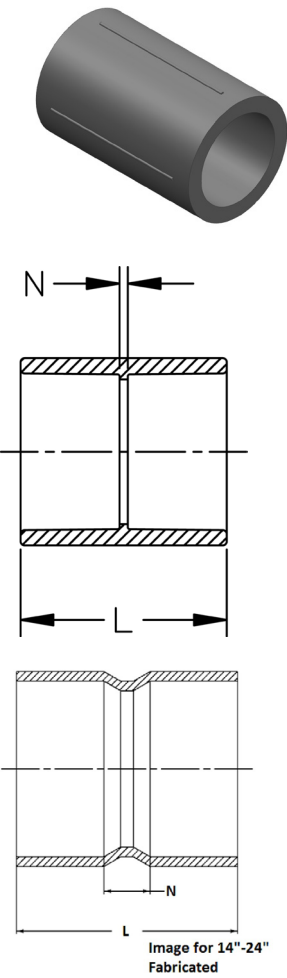

Size (inch)	P/L	Part No.	Pack Qty	L (inch)	N (inch)	Design
¾	608	<b>829-003</b>	50	1.65	0.11	HS
½	608	<b>829-005</b>	25	1.93	0.12	SL
¾	608	<b>829-007</b>	20	2.18	0.12	SL
1	608	<b>829-010</b>	25	2.41	0.12	SL
1 ¼	608	<b>829-012</b>	10	2.67	0.13	SL
1 ½	608	<b>829-015</b>	10	2.94	0.15	SL
2	608	<b>829-020</b>	20	3.18	0.13	SL
2 ½	608	<b>829-025</b>	5	3.77	0.19	SL
3	608	<b>829-030</b>	5	4.04	0.26	SL
4	608	<b>829-040</b>	5	4.80	0.26	SL
6	608	<b>829-060</b>	2	6.40	0.36	SL
8	608	<b>829-080</b>	2	8.40	0.35	SL
10	602	<b>829-100</b>	1	10.77	0.75	SL
12	602	<b>829-120</b>	1	12.82	0.75	SL
14	A33	<b>829-140N</b>	1	17.75	3.75	FAB
16	A33	<b>829-160N</b>	1	20.25	4.25	FAB
18	A33	<b>829-180N</b>	1	22.75	4.75	FAB
20	A33	<b>829-200N</b>	1	25.25	5.25	FAB
24	A33	<b>829-240N</b>	1	30.25	6.25	FAB

Image for 14"-24"  
Fabricated

Reducing Coupling (S x S) Schedule 80 Harvel® PVC

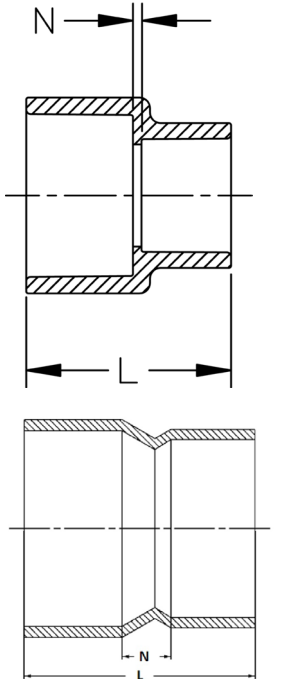
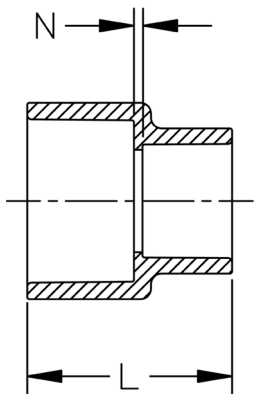

Image for 14"-24"  
Fabricated

Size (inch)	P/L	Part No.	Pack Qty	L (inch)	N (inch)	Design
¾ x ½	608	<b>829-101</b>	20	2.13	0.13	HS
1 x ½	608	<b>829-130</b>	25	2.17	0.12	HS
1 x ¾	608	<b>829-131</b>	25	2.26	0.11	HS
1 ¼ x 1	608	<b>829-168</b>	10	2.52	0.10	HS
1 ½ x ½	608	<b>829-209FB</b>	10	2.94	0.66	BUSH
1 ½ x ¾	608	<b>829-210</b>	10	2.50	0.09	BUSH
1 ½ x 1	608	<b>829-211</b>	10	2.65	0.11	HS
1 ½ x 1 ¼	608	<b>829-212</b>	10	2.82	0.09	HS
2 x ½	608	<b>829-247FB</b>	5	3.44	0.87	BUSH
2 x ¾	608	<b>829-248</b>	5	3.14	0.34	HS
2 x 1	608	<b>829-249</b>	5	3.15	0.32	HS
2 x 1 ¼	608	<b>829-250</b>	5	3.05	0.14	HS
2 x 1 ½	608	<b>829-251</b>	5	3.06	0.07	HS
2 ½ x 1 ½	608	<b>829-291</b>	5	3.36	0.14	HS
2 ½ x 2	608	<b>829-292FB</b>	5	4.08	0.66	BUSH
3 x 1	608	<b>829-335FB</b>	5	4.56	1.53	BUSH
3 x 1 ¼	608	<b>829-336FB</b>	5	4.29	1.07	FAB
3 x 1 ½	608	<b>829-337FB</b>	5	4.58	1.15	BUSH
3 x 2	608	<b>829-338</b>	5	3.61	0.17	HS
3 x 2 ½	608	<b>829-339FB</b>	5	4.42	0.63	BUSH
4 x 2	608	<b>829-420FB</b>	5	4.94	1.08	BUSH
4 x 3	608	<b>829-422</b>	5	4.38	0.22	HS
6 x 2	608	<b>829-528FB</b>	2	10.61	4.60	BUSH
6 x 4	608	<b>829-532</b>	2	10.17	3.46	HS
8 x 4	608	<b>829-582FB</b>	2	9.81	3.53	BUSH
8 x 6	608	<b>829-585</b>	2	9.18	2.11	HS
10 x 4	A33	<b>829-623N</b>	1	17.00	10.00	FAB
10 x 6	602	<b>829-626FB</b>	1	11.42	3.29	BUSH
10 x 6	A33	<b>829-626N</b>	1	13.00	5.00	FAB
10 x 8	602	<b>829-628FB</b>	1	11.45	2.32	BUSH
10 x 8	A33	<b>829-628N</b>	1	12.75	3.75	FAB
12 x 4	A33	<b>829-663N</b>	1	26.25	18.25	FAB
12 x 6	A33	<b>829-666N</b>	1	20.50	11.50	FAB
12 x 8	602	<b>829-668FB</b>	1	13.54	3.41	BUSH
12 x 8	A33	<b>829-668N</b>	1	15.50	5.50	FAB
12 x 10	602	<b>829-670FB</b>	1	13.24	2.13	BUSH
12 x 10	A33	<b>829-670N</b>	1	15.00	4.00	FAB
14 x 4	A33	<b>829-696N</b>	1	21.00	3.00	FAB
14 x 6	A33	<b>829-698N</b>	1	31.00	21.00	FAB
14 x 8	A33	<b>829-700N</b>	1	21.00	10.00	FAB
14 x 10	A33	<b>829-702N</b>	1	17.00	5.00	FAB
14 x 12	A33	<b>829-704N</b>	1	16.50	3.50	FAB
16 x 4	A33	<b>829-730N</b>	1	16.50	3.50	FAB
16 x 6	A33	<b>829-732N</b>	1	16.50	4.50	FAB
16 x 8	A33	<b>829-734N</b>	1	18.05	5.00	FAB
16 x 10	A33	<b>829-736N</b>	1	19.50	6.50	FAB
16 x 12	A33	<b>829-738N</b>	1	19.25	5.25	FAB
16 x 14	A33	<b>829-740N</b>	1	19.50	4.50	FAB
18 x 4	A33	<b>829-784N</b>	1	48.50	37.50	FAB
18 x 6	A33	<b>829-786N</b>	1	36.00	24.00	FAB
18 x 8	A33	<b>829-788N</b>	1	42.50	29.50	FAB
18 x 10	A33	<b>829-790N</b>	1	33.50	19.50	FAB
18 x 12	A33	<b>829-792N</b>	1	22.00	7.00	FAB
18 x 14	A33	<b>829-794N</b>	1	22.25	6.25	FAB
18 x 16	A33	<b>829-796N</b>	1	21.75	4.75	FAB
20 x 4	A33	<b>829-814N</b>	1	60.50	48.50	FAB
20 x 6	A33	<b>829-816N</b>	1	55.50	42.50	FAB
20 x 8	A33	<b>829-818N</b>	1	56.25	42.25	FAB
20 x 10	A33	<b>829-820N</b>	1	47.25	32.25	FAB
20 x 12	A33	<b>829-822N</b>	1	37.00	21.00	FAB

table continued on the next page





Size (inch)	P/L	Part No.	Pack Qty	L (inch)	N (inch)	Design
20 x 14	A33	<b>829-824N</b>	1	37.25	20.25	FAB
20 x 16	A33	<b>829-826N</b>	1	24.50	6.50	FAB
20 x 18	A33	<b>829-828N</b>	1	25.25	6.25	FAB
24 x 4	A33	<b>829-904N</b>	1	66.00	52.00	FAB
24 x 6	A33	<b>829-906N</b>	1	61.00	46.00	FAB
24 x 8	A33	<b>829-908N</b>	1	52.00	36.00	FAB
24 x 10	A33	<b>829-910N</b>	1	52.75	35.75	FAB
24 x 12	A33	<b>829-912N</b>	1	42.50	24.50	FAB
24 x 14	A33	<b>829-914N</b>	1	42.75	23.75	FAB
24 x 16	A33	<b>829-916N</b>	1	42.25	22.25	FAB
24 x 18	A33	<b>829-918N</b>	1	29.50	8.50	FAB
24 x 20	A33	<b>829-920N</b>	1	29.25	7.25	FAB

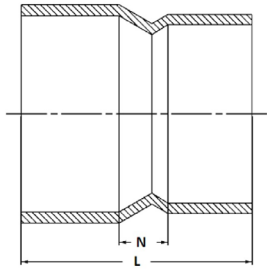
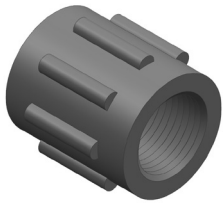
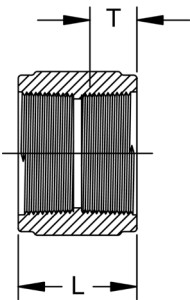

Image for 14"-24"  
Fabricated

#### Coupling (FPT x FPT) Schedule 80 Harvel® PVC



Size (inch)	P/L	Part No.	Pack Qty	L (inch)	T (inch)	Design
¼	608	<b>830-002</b>	50	1.29	0.61	HS
¾	608	<b>830-003</b>	50	1.35	0.62	HS
½	608	<b>830-005</b>	25	1.68	0.77	SL
¾	608	<b>830-007</b>	20	1.75	0.80	SL
1	608	<b>830-010</b>	25	2.13	0.99	SL
1 ¼	608	<b>830-012</b>	10	2.19	1.03	SL
1 ½	608	<b>830-015</b>	10	2.22	1.03	SL
2	608	<b>830-020</b>	5	2.29	1.08	SL
2 ½	608	<b>830-025</b>	5	3.33	1.51	SL
3	608	<b>830-030</b>	5	3.53	1.65	SL
4	608	<b>830-040</b>	5	3.76	1.75	SL



### Reducing Coupling (FPT x FPT) Schedule 80 Harvel® PVC

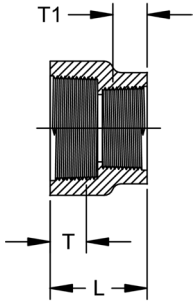

Size (inch)	P/L	Part No.	Pack Qty	L (inch)	T (inch)	T1 (inch)	Design
3/8 x 1/4	608	<b>830-052</b>	50	1.29	0.60	0.59	HS
1/2 x 1/4	608	<b>830-072</b>	50	1.44	0.75	0.59	HS
1/2 x 3/8	608	<b>830-073</b>	50	1.46	0.74	0.60	HS
3/4 x 1/2	608	<b>830-101</b>	25	1.68	0.78	0.78	HS
1 x 1/2	608	<b>830-130</b>	25	1.84	0.98	0.77	HS
1 x 3/4	608	<b>830-131</b>	25	1.88	0.98	0.80	HS
1 1/4 x 3/4	608	<b>830-167</b>	25	1.90	1.00	0.79	HS
1 1/2 x 1	608	<b>830-211</b>	20	2.06	1.02	0.95	HS
2 x 1 1/2	608	<b>830-251</b>	10	2.18	1.05	1.02	HS

### Female Adapter (S x FPT) Schedule 80 Harvel® PVC

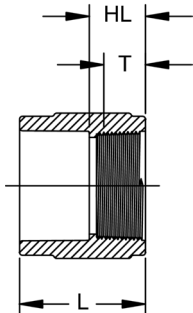

Size (inch)	P/L	Part No.	Pack Qty	HL (inch)	L (inch)	T (inch)	Design
1/4	608	<b>835-002</b>	50	0.75	1.43	0.58	HS
3/8	608	<b>835-003</b>	50	0.75	1.56	0.62	HS
1/2	608	<b>835-005</b>	25	0.91	1.80	0.75	HS
3/4	608	<b>835-007</b>	25	0.95	1.96	0.79	HS
1	608	<b>835-010</b>	25	1.11	2.27	0.98	HS
1 1/4	608	<b>835-012</b>	10	1.18	2.44	1.02	HS
1 1/2	608	<b>835-015</b>	10	1.19	2.59	1.03	HS
2	608	<b>835-020</b>	5	1.25	2.76	1.06	HS
2 1/2	608	<b>835-025</b>	5	1.77	3.53	1.51	HS
3	608	<b>835-030</b>	5	1.91	3.80	1.65	HS
4	608	<b>835-040</b>	5	2.02	4.29	1.74	HS
6	608	<b>835-060</b>	2	3.27	6.37	2.37	SL
8	608	<b>835-080</b>	2	4.35	8.36	2.35	HS
10	602	<b>835-100</b>	2	5.68	10.78	2.68	HS
12	A33	<b>835-120N</b>	1	6.00	11.13	2.13	FAB

### Male Adapter (S x MPT) Schedule 80 Harvel® PVC

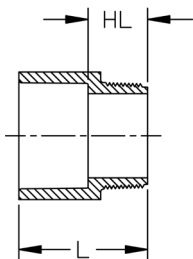

Size (inch)	P/L	Part No.	Pack Qty	HL (inch)	L (inch)	Design
1/2	608	<b>836-005</b>	50	0.94	1.85	SL
3/4	608	<b>836-007</b>	25	1.05	2.03	HS
1	608	<b>836-010</b>	25	1.22	2.38	HS
1 1/4	608	<b>836-012</b>	15	1.28	2.56	HS
1 1/2	608	<b>836-015</b>	10	1.30	2.69	HS
2	608	<b>836-020</b>	5	1.32	2.83	HS
2 1/2	608	<b>836-025</b>	5	1.87	3.70	HS
3	608	<b>836-030</b>	5	1.99	3.90	HS
4	608	<b>836-040</b>	5	2.15	4.40	HS
6	A33	<b>836-060N</b>	1	3.25	6.25	FAB
8	A33	<b>836-080N</b>	1	3.50	7.50	FAB
10	A33	<b>836-100N</b>	1	4.18	9.18	FAB
12	A33	<b>836-120N</b>	1	4.63	10.63	FAB

Flush Style Reducer Bushing (SPG x S) Schedule 80 Harvel® PVC

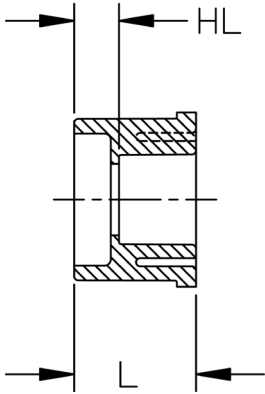
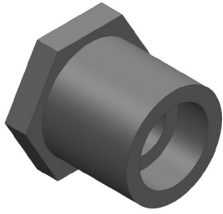

Size (inch)	P/L	Part No.	Pack Qty	HL (inch)	L (inch)	Design
½ x ¼	608	<b>837-072</b>	50	0.47	1.15	FLUSH
½ x ⅜	608	<b>837-073</b>	50	0.33	1.09	FLUSH
¾ x ½	608	<b>837-101</b>	50	0.42	1.30	FLUSH
1 x ½	608	<b>837-130</b>	50	0.55	1.44	FLUSH
1 x ¾	608	<b>837-131</b>	50	0.41	1.43	FLUSH
1 ¼ x ½	608	<b>837-166</b>	25	0.66	1.55	FLUSH
1 ¼ x ¾	608	<b>837-167</b>	25	0.56	1.57	FLUSH
1 ¼ x 1	608	<b>837-168</b>	25	0.44	1.59	FLUSH
1 ½ x ½	608	<b>837-209</b>	25	0.78	1.69	FLUSH
1 ½ x ¾	608	<b>837-210</b>	25	0.67	1.68	FLUSH
1 ½ x 1	608	<b>837-211</b>	25	0.55	1.69	FLUSH
1 ½ x 1 ¼	608	<b>837-212</b>	25	0.44	1.72	FLUSH
2 x ½	608	<b>837-247</b>	10	0.91	1.81	FLUSH
2 x ¾	608	<b>837-248</b>	10	0.79	1.82	FLUSH
2 x 1	608	<b>837-249</b>	10	0.68	1.83	FLUSH
2 x 1 ¼	608	<b>837-250</b>	10	0.54	1.81	FLUSH
2 x 1 ½	608	<b>837-251</b>	10	0.40	1.81	FLUSH
2 ½ x 1 ½	608	<b>837-291</b>	5	0.79	2.31	FLUSH
2 ½ x 2	608	<b>837-292</b>	5	0.47	2.10	FLUSH
3 x 1	608	<b>837-335</b>	5	1.27	2.42	FLUSH
3 x 1 ¼	608	<b>837-336FB</b>	5	1.43	2.71	BUSH
3 x 1 ½	608	<b>837-337</b>	5	0.89	2.43	FLUSH
3 x 2	608	<b>837-338</b>	5	0.86	2.42	FLUSH
3 x 2 ½	608	<b>837-339</b>	5	0.38	2.27	FLUSH
4 x 2	608	<b>837-420</b>	5	1.14	2.70	FLUSH
4 x 3	608	<b>837-422</b>	5	0.77	2.74	FLUSH
6 x 3	608	<b>837-530</b>	2	1.74	3.65	FLUSH
6 x 4	608	<b>837-532</b>	2	1.42	3.67	FLUSH
8 x 6	608	<b>837-585</b>	2	1.69	4.66	FLUSH
10 x 4	602	<b>837-623FB</b>	1	4.01	6.26	BUSH
10 x 6	602	<b>837-626</b>	1	2.59	5.69	FLUSH
10 x 8	602	<b>837-628</b>	1	1.62	5.72	FLUSH
12 x 6	602	<b>837-666FB</b>	1	4.26	7.35	BUSH
12 x 8	602	<b>837-668</b>	1	2.66	6.76	FLUSH
12 x 10	602	<b>837-670</b>	1	1.66	6.77	FLUSH
14 x 4	A33	<b>837-696N</b>	1	5.50	7.50	FAB
14 x 6	A33	<b>837-698N</b>	1	4.50	7.50	FAB
14 x 8	A33	<b>837-700N</b>	1	3.50	7.50	FAB
14 x 10	A33	<b>837-702N</b>	1	2.50	7.50	FAB
14 x 12	A33	<b>837-704N</b>	1	1.50	7.50	FAB
16 x 4	A33	<b>837-730N</b>	1	6.50	8.50	FAB
16 x 6	A33	<b>837-732N</b>	1	5.50	8.50	FAB
16 x 8	A33	<b>837-734N</b>	1	4.50	8.50	FAB
16 x 10	A33	<b>837-736N</b>	1	3.50	8.50	FAB
16 x 12	A33	<b>837-738N</b>	1	2.50	8.50	FAB
16 x 14	A33	<b>837-740N</b>	1	1.50	8.50	FAB
18 x 4	A33	<b>837-784N</b>	1	7.50	9.50	FAB
18 x 6	A33	<b>837-786N</b>	1	6.50	9.50	FAB
18 x 8	A33	<b>837-788N</b>	1	5.50	9.50	FAB
18 x 10	A33	<b>837-790N</b>	1	4.50	9.50	FAB
18 x 12	A33	<b>837-792N</b>	1	3.50	9.50	FAB
18 x 14	A33	<b>837-794N</b>	1	2.50	9.50	FAB
18 x 16	A33	<b>837-796N</b>	1	1.50	9.50	FAB
20 x 4	A33	<b>837-814N</b>	1	8.50	10.50	FAB
20 x 6	A33	<b>837-816N</b>	1	7.50	10.50	FAB
20 x 8	A33	<b>837-818N</b>	1	6.50	10.50	FAB
20 x 10	A33	<b>837-820N</b>	1	5.50	10.50	FAB
20 x 12	A33	<b>837-822N</b>	1	4.50	10.50	FAB
20 x 14	A33	<b>837-824N</b>	1	3.50	10.50	FAB
20 x 16	A33	<b>837-826N</b>	1	2.50	10.50	FAB

table continued on the next page

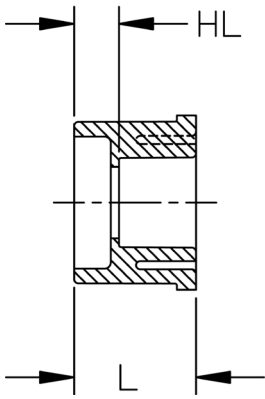

Size (inch)	P/L	Part No.	Pack Qty	HL (inch)	L (inch)	Design
20 x 18	A33	<b>837-828N</b>	1	1.50	10.50	FAB
24 x 4	A33	<b>837-904N</b>	1	10.50	12.50	FAB
24 x 6	A33	<b>837-906N</b>	1	9.50	12.50	FAB
24 x 8	A33	<b>837-908N</b>	1	8.50	12.50	FAB
24 x 10	A33	<b>837-910N</b>	1	7.50	12.50	FAB
24 x 12	A33	<b>837-912N</b>	1	6.50	12.50	FAB
24 x 14	A33	<b>837-914N</b>	1	5.50	12.50	FAB
24 x 16	A33	<b>837-916N</b>	1	4.50	12.50	FAB
24 x 18	A33	<b>837-918N</b>	1	3.50	12.50	FAB
24 x 20	A33	<b>837-920N</b>	1	2.50	12.50	FAB

### Flush Style Reducer Bushing (SPG x FPT) Schedule 80 Harvel® PVC

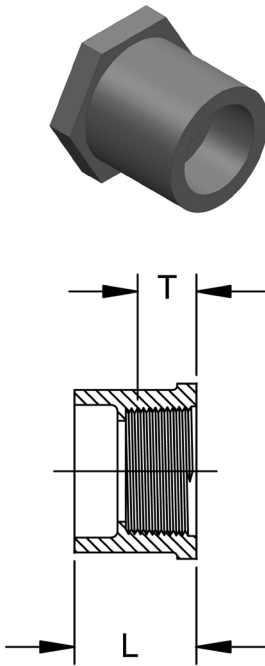

Size (inch)	P/L	Part No.	Pack Qty	L (inch)	T (inch)	Design
3/8 x 1/4	608	<b>838-052E</b>	50	1.59	0.60	Extended
1/2 x 1/4	608	<b>838-072</b>	50	1.14	0.61	FLUSH
1/2 x 3/8	608	<b>838-073</b>	50	1.21	0.60	FLUSH
3/4 x 1/4	608	<b>838-098</b>	50	1.13	0.61	FLUSH
3/4 x 1/2	608	<b>838-101</b>	50	1.28	0.77	FLUSH
1 x 1/2	608	<b>838-130</b>	50	1.42	0.76	FLUSH
1 x 3/4	608	<b>838-131</b>	50	1.41	0.81	FLUSH
1 1/4 x 1/2	608	<b>838-166</b>	15	1.56	0.75	FLUSH
1 1/4 x 3/4	608	<b>838-167</b>	15	1.56	0.79	FLUSH
1 1/4 x 1	608	<b>838-168</b>	15	1.56	0.99	FLUSH
1 1/2 x 1/2	608	<b>838-209</b>	15	1.68	0.76	FLUSH
1 1/2 x 3/4	608	<b>838-210</b>	15	1.69	0.79	FLUSH
1 1/2 x 1	608	<b>838-211</b>	15	1.68	0.99	FLUSH
1 1/2 x 1 1/4	608	<b>838-212</b>	15	1.69	1.10	FLUSH
2 x 1/2	608	<b>838-247</b>	10	1.80	0.77	FLUSH
2 x 3/4	608	<b>838-248</b>	10	1.80	0.80	FLUSH
2 x 1	608	<b>838-249</b>	10	1.80	0.99	FLUSH
2 x 1 1/4	608	<b>838-250</b>	10	1.81	1.02	FLUSH
2 x 1 1/2	608	<b>838-251</b>	10	1.88	1.04	FLUSH
2 1/2 x 1 1/2	608	<b>838-291</b>	5	2.24	1.07	FLUSH
2 1/2 x 2	608	<b>838-292</b>	5	2.12	1.10	FLUSH
3 x 2	608	<b>838-338</b>	5	2.42	1.07	FLUSH
3 x 2 1/2	608	<b>838-339</b>	5	2.25	1.61	FLUSH
4 x 2	608	<b>838-420</b>	5	2.71	1.10	FLUSH
4 x 3	608	<b>838-422</b>	5	2.75	1.62	FLUSH

### Flush Style Reducer Bushing (MPT x FPT) Schedule 80 Harvel® PVC

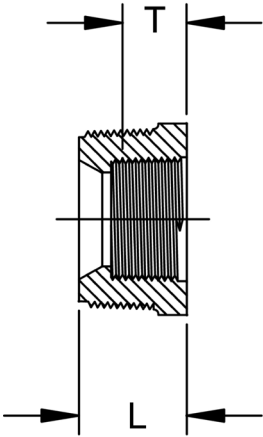
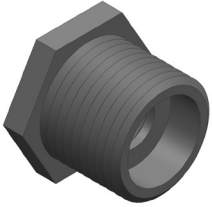

Size (inch)	P/L	Part No.	Pack Qty	L (inch)	T (inch)	Style
3/8 x 1/4	608	<b>839-052</b>	50	0.80	0.60	FLUSH
1/2 x 1/4	608	<b>839-072</b>	50	0.95	0.60	FLUSH
1/2 x 3/8	608	<b>839-073</b>	50	0.96	0.61	FLUSH
3/4 x 1/4	608	<b>839-098</b>	50	1.01	0.61	FLUSH
3/4 x 3/8	608	<b>839-099</b>	50	1.02	0.61	FLUSH
3/4 x 1/2	608	<b>839-101</b>	50	1.08	0.75	FLUSH
1 x 1/4	608	<b>839-128</b>	25	1.23	0.58	FLUSH
1 x 1/2	608	<b>839-130</b>	25	1.24	0.76	FLUSH
1 x 3/4	608	<b>839-131</b>	25	1.28	0.80	FLUSH
1 1/4 x 1/2	608	<b>839-166</b>	25	1.29	0.76	FLUSH
1 1/4 x 3/4	608	<b>839-167</b>	25	1.29	0.79	FLUSH
1 1/4 x 1	608	<b>839-168</b>	25	1.30	1.00	FLUSH
1 1/2 x 3/4	608	<b>839-210</b>	25	1.33	0.78	FLUSH
1 1/2 x 1	608	<b>839-211</b>	25	1.34	0.98	FLUSH
1 1/2 x 1 1/4	608	<b>839-212</b>	25	1.33	1.02	FLUSH
2 x 1/2	608	<b>839-247</b>	10	1.44	0.76	FLUSH
2 x 3/4	608	<b>839-248</b>	10	1.44	0.80	FLUSH
2 x 1	608	<b>839-249</b>	10	1.42	0.97	FLUSH
2 x 1 1/4	608	<b>839-250</b>	10	1.43	1.01	FLUSH
2 x 1 1/2	608	<b>839-251</b>	10	1.35	1.02	FLUSH
3 x 2	608	<b>839-338</b>	5	2.02	1.09	FLUSH
4 x 2	608	<b>839-420</b>	5	2.07	1.10	FLUSH
4 x 3	608	<b>839-422</b>	5	2.06	1.60	FLUSH

### Cap (S) Schedule 80 Harvel® PVC

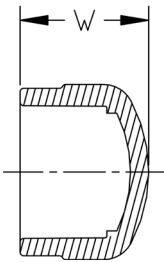

Size (inch)	P/L	Part No.	Pack Qty	W (inch)	Design
1/4	608	<b>847-002</b>	50	0.96	HS
3/8	608	<b>847-003</b>	50	1.11	HS
1/2	608	<b>847-005</b>	50	1.30	HS
3/4	608	<b>847-007</b>	50	1.46	HS
1	608	<b>847-010</b>	25	1.66	HS
1 1/4	608	<b>847-012</b>	15	1.89	HS
1 1/2	608	<b>847-015</b>	10	2.08	HS
2	608	<b>847-020</b>	5	2.32	HS
2 1/2	608	<b>847-025</b>	5	2.61	HS
3	608	<b>847-030</b>	5	3.06	HS
4	608	<b>847-040</b>	5	3.69	HS
6	608	<b>847-060</b>	2	4.86	HS
8	608	<b>847-080</b>	2	6.25	SL
10	602	<b>847-100</b>	1	7.92	SL
12	602	<b>847-120</b>	1	9.37	SL
14	A33	<b>847-140N</b>	1	5.75	FAB
16	A33	<b>847-160N</b>	1	7.00	FAB
18	A33	<b>847-180N</b>	1	8.25	FAB
20	A33	<b>847-200N</b>	1	8.75	FAB
24	A33	<b>847-240N</b>	1	10.25	FAB



**Cap (FPT) Schedule 80 Harvel® PVC**

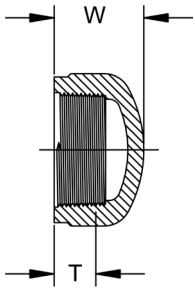
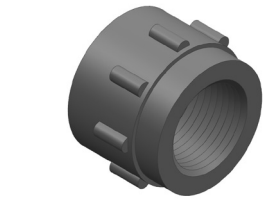

Size (inch)	P/L	Part No.	Pack Qty	W (inch)	T (inch)	Design
¼	608	<b>848-002</b>	50	0.93	0.54	HS
⅜	608	<b>848-003</b>	50	0.94	0.62	HS
½	608	<b>848-005</b>	50	1.14	0.74	HS
¾	608	<b>848-007</b>	25	1.25	0.80	HS
1	608	<b>848-010</b>	25	1.51	0.97	HS
1 ¼	608	<b>848-012</b>	15	1.59	1.00	HS
1 ½	608	<b>848-015</b>	10	1.70	1.01	HS
2	608	<b>848-020</b>	5	1.82	1.06	HS
2 ½	608	<b>848-025</b>	5	2.61	1.45	HS
3	608	<b>848-030</b>	5	2.80	1.83	HS
4	608	<b>848-040</b>	5	3.16	1.80	HS

**Plug (SPG) Schedule 80 Harvel® PVC**

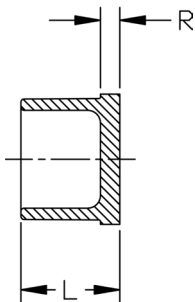
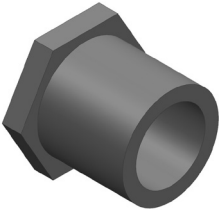

Size (inch)	P/L	Part No.	Pack Qty	L (inch)	R (inch)
½	608	<b>849-005</b>	50	1.08	0.18
¾	608	<b>849-007</b>	50	1.25	0.22
1	608	<b>849-010</b>	25	1.41	0.25
1 ½	608	<b>849-015</b>	20	1.72	0.31
2	608	<b>849-020</b>	10	1.90	0.38
4	608	<b>849-040</b>	5	2.65	0.39

**Plug (MPT) Schedule 80 Harvel® PVC**

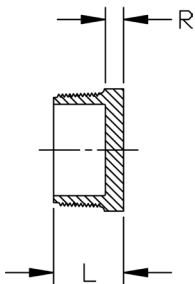
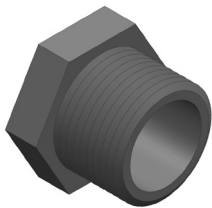

Size (inch)	P/L	Part No.	Pack Qty	L (inch)	R (inch)	Design
¼	608	<b>850-002</b>	50	0.81	0.22	HS
⅜	608	<b>850-003</b>	50	0.83	0.22	HS
½	608	<b>850-005</b>	50	0.98	0.22	HS
¾	608	<b>850-007</b>	50	1.06	0.25	HS
1	608	<b>850-010</b>	25	1.24	0.27	HS
1 ¼	608	<b>850-012</b>	25	1.33	0.31	HS
1 ½	608	<b>850-015</b>	20	1.38	0.34	HS
2	608	<b>850-020</b>	10	1.47	0.39	HS
2 ½	608	<b>850-025</b>	10	1.95	0.38	HS
3	608	<b>850-030</b>	5	1.98	0.38	HS
4	608	<b>850-040</b>	5	2.16	0.39	HS
6	A33	<b>850-060N</b>	1	2.00	0.75	FAB
8	A33	<b>850-080N</b>	1	2.00	0.75	FAB
10	A33	<b>850-100N</b>	1	2.00	0.75	FAB
12	A33	<b>850-120N</b>	1	2.00	0.75	FAB

### Flange - One Piece (S) Schedule 80 Harvel® PVC

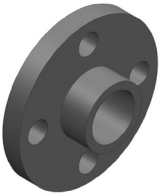

- ANSI 150 Class according to ANSI B16.5
- 150 psi @ 73°F (10.3 bar @ 22.7°C)
- HC = Honeycomb (Face)

Size (inch)	P/L	Part No.	Pack Qty	# holes	Bolt Dia. (inch)	bolt cir. dia. (inch)	D (inch)	L (inch)	N1 (inch)	R (inch)	Design
½	608	<b>851-005</b>	5	4	½	2.38	3.50	1.02	0.13	0.39	HC
¾	608	<b>851-007</b>	5	4	½	2.75	3.89	1.14	0.13	0.45	HC
1	608	<b>851-010</b>	5	4	½	3.13	4.28	1.30	0.16	0.52	HC
1 ¼	608	<b>851-012</b>	5	4	½	3.50	4.64	1.45	0.14	0.59	HC
1 ½	608	<b>851-015</b>	5	4	½	3.88	5.01	1.54	0.16	0.68	HC
2	608	<b>851-020</b>	5	4	¾	4.75	6.01	1.73	0.16	0.69	HC
2 ½	608	<b>851-025</b>	5	4	¾	5.50	7.00	1.99	0.17	0.75	HC
3	608	<b>851-030</b>	5	4	¾	6.00	7.51	2.46	0.57	1.10	HC
4	608	<b>851-040</b>	5	8	¾	7.50	9.04	2.79	0.52	1.19	HC
6	608	<b>851-060</b>	2	8	¾	9.50	11.13	3.88	0.36	1.38	HC
8	608	<b>851-080</b>	2	8	¾	11.75	13.54	4.90	0.42	1.45	HC

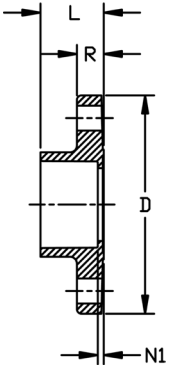

### Flange - One Piece (FPT) Schedule 80 Harvel® PVC

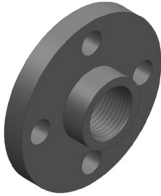

- ANSI 150 Class according to ANSI B16.5
- 150 psi @ 73°F (10.3 bar @ 22.7°C)
- HC = Honeycomb (Face)

Size (inch)	P/L	Part No.	Pack Qty	# holes	Bolt Dia. (inch)	bolt cir. dia. (inch)	D (inch)	L (inch)	T (inch)	R (inch)	Design
½	608	<b>852-005</b>	5	4	½	2.38	3.51	0.89	0.77	0.39	HC
¾	608	<b>852-007</b>	5	4	½	2.75	3.89	0.91	0.79	0.45	HC
1	608	<b>852-010</b>	5	4	½	3.13	4.28	1.13	1.00	0.53	HC
1 ¼	608	<b>852-012</b>	5	4	½	3.50	4.62	1.20	1.06	0.58	HC
1 ½	608	<b>852-015</b>	5	4	½	3.88	4.99	1.19	1.03	0.68	HC
2	608	<b>852-020</b>	5	4	¾	4.75	6.02	1.22	1.06	0.70	HC
2 ½	608	<b>852-025</b>	5	4	¾	5.50	7.00	1.72	1.53	0.75	HC
3	608	<b>852-030</b>	5	4	¾	6.00	7.50	2.15	1.63	1.15	HC
4	608	<b>852-040</b>	5	8	¾	7.50	9.00	2.30	1.77	1.23	HC

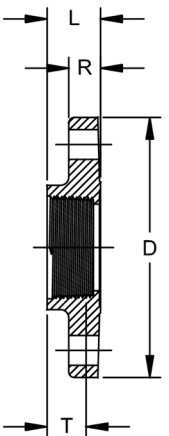

### Flange - Van Stone (S) Schedule 80 Harvel® PVC

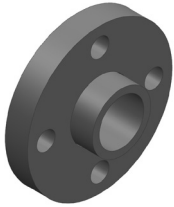

- ANSI 150 Class according to ANSI B16.5
- 1/2" - 12" pressure rating is 150 psi @ 73°F (10.3 bar @ 22.7°C)
- 14" - 24" pressure rating is 100 psi @ 73°F (6.9 bar @ 22.7°C) - Steel Ring
- HC = Honeycomb (Face)

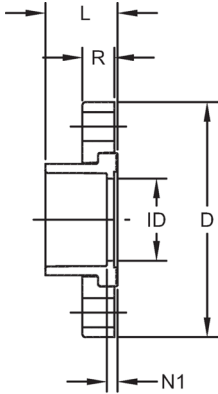

Size (inch)	P/L	Part No.	Pack Qty	# holes	Bolt Dia. (inch)	bolt cir. dia. (inch)	D (inch)	L (inch)	N1 (inch)	R (inch)	ID (inch)	Design
1/2	608	854-005	5	4	1/2	2.38	3.53	1.10	0.18	0.57	0.60	HC
3/4	608	854-007	5	4	1/2	2.75	3.87	1.23	0.18	0.59	0.82	HC
1	608	854-010	5	4	1/2	3.13	4.25	1.38	0.20	0.66	1.03	HC
1 1/4	608	854-012	5	4	1/2	3.50	4.62	1.52	0.21	0.69	1.36	HC
1 1/2	608	854-015	5	4	1/2	3.88	5.01	1.68	0.25	0.75	1.60	HC
2	608	854-020	5	4	5/8	4.75	6.02	1.84	0.29	0.82	2.06	HC
2 1/2	608	854-025	5	4	5/8	5.50	7.01	2.15	0.33	0.98	2.49	HC
3	608	854-030	5	4	5/8	6.00	7.50	2.33	0.39	1.02	3.09	HC
4	608	854-040	5	8	5/8	7.50	8.99	2.75	0.24	1.10	4.06	HC
6	608	854-060	2	8	3/4	9.50	10.98	3.55	0.48	1.25	6.11	HC
8	608	854-080	2	8	3/4	11.75	13.51	4.60	0.51	1.71	8.00	HC
10	602	854-100	2	12	7/8	14.25	15.97	5.66	0.53	1.73	10.10	HC
12	602	854-120	2	12	7/8	17.00	18.95	6.71	0.57	1.72	11.96	HC
14	A33	854-140N	1	12	1	18.75	21.00	11.75	4.75	0.50	12.50	FAB
16	A33	854-160N	1	16	1	21.25	23.50	13.50	5.50	0.50	14.31	FAB
18	A33	854-180N	1	16	1 1/8	22.75	25.00	14.50	5.50	0.50	16.13	FAB
20	A33	854-200N	1	20	1 1/8	25.00	27.50	17.25	7.25	0.50	18.00	FAB
24	A33	854-240N	1	20	1 1/4	29.50	32.00	19.50	7.50	0.50	21.56	FAB

### Flange - Van Stone (FPT) Schedule 80 Harvel® PVC

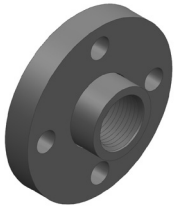

- ANSI 150 Class according to ANSI B16.5
- 150 psi @ 73°F (10.3 bar @ 22.7°C)
- HC = Honeycomb (Face)

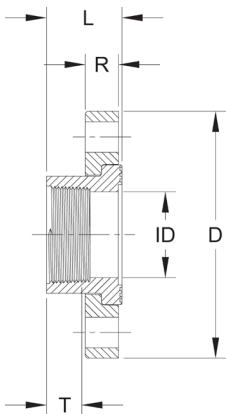

Size (inch)	P/L	Part No.	Pack Qty	# holes	Bolt Dia. (inch)	bolt cir. dia. (inch)	D (inch)	L (inch)	T (inch)	R (inch)	ID (inch)	Design
1/2	608	855-005	5	4	1/2	2.38	3.53	1.10	0.79	0.57	0.63	HC
3/4	608	855-007	5	4	1/2	2.75	3.87	1.23	0.82	0.59	0.83	HC
1	608	855-010	5	4	1/2	3.13	4.25	1.39	1.01	0.66	1.06	HC
1 1/4	608	855-012	5	4	1/2	3.50	4.62	1.50	1.02	0.69	1.38	HC
1 1/2	608	855-015	5	4	1/2	3.88	5.01	1.67	1.06	0.75	1.61	HC
2	608	855-020	5	4	5/8	4.75	6.02	1.82	1.09	0.82	2.08	HC
2 1/2	608	855-025	5	4	5/8	5.50	7.01	2.13	1.58	0.98	2.50	HC
3	608	855-030	5	4	5/8	6.00	7.50	2.36	1.71	1.02	3.08	HC
4	608	855-040	5	8	5/8	7.50	8.99	2.78	1.72	1.10	4.09	HC

### Flange - Van Stone (SPG) Schedule 80 Harvel® PVC

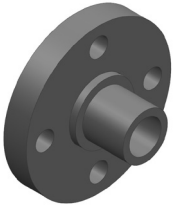

- ANSI 150 Class according to ANSI B16.5
  - 1/2" - 12" pressure rating is 150 psi @ 73°F (10.3 bar @ 22.7°C)
  - 14" - 24" pressure rating is 100 psi @ 73°F (6.9 bar @ 22.7°C) - Steel Ring
- HC = Honeycomb (Face)

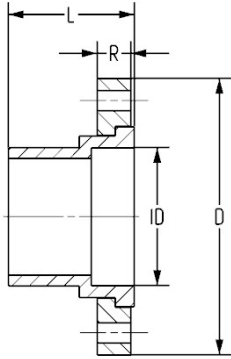

Size (inch)	P/L	Part No.	Pack Qty	# holes	Bolt Dia. (inch)	bolt cir. dia. (inch)	D (inch)	L (inch)	R (inch)	ID (inch)	Design
1/2	608	856-005	5	4	1/2	2.38	3.53	1.72	0.57	0.84	HC
3/4	608	856-007	5	4	1/2	2.75	3.87	1.85	0.59	1.05	HC
1	608	856-010	5	4	1/2	3.13	4.25	2.10	0.66	1.32	HC
1 1/4	608	856-012	5	4	1/2	3.50	4.62	2.28	0.69	1.66	HC
1 1/2	608	856-015	5	4	1/2	3.88	5.01	2.48	0.75	1.90	HC
2	608	856-020	5	4	3/4	4.75	6.02	2.80	0.82	2.38	HC
2 1/2	608	856-025	5	4	3/4	5.50	7.01	3.27	0.98	2.86	HC
3	608	856-030	5	4	3/4	6.00	7.50	3.60	1.02	3.49	HC
4	608	856-040	5	8	3/4	7.50	8.99	4.10	1.10	4.49	HC
6	608	856-060	2	8	3/4	9.50	10.98	5.10	1.25	6.60	HC
8	608	856-080	1	8	3/4	11.75	13.51	6.88	1.71	8.62	HC
10	602	856-100	1	12	7/8	14.25	15.97	8.30	1.73	10.70	HC
12	602	856-120	1	12	7/8	17.00	18.95	9.55	1.72	12.69	HC
14	A33	856-140N	1	12	1	18.75	21.00	13.00	0.50	11.41	FAB
16	A33	856-160N	1	16	1	21.25	23.50	14.00	0.50	13.08	FAB
18	A33	856-180N	1	16	1 1/4	22.75	25.00	16.00	0.50	14.76	FAB
20	A33	856-200N	1	20	1 1/4	25.00	27.50	18.00	0.50	16.43	FAB
24	A33	856-240N	1	20	1 1/4	29.50	32.00	20.00	0.50	19.79	FAB

### Flange (Blind) Schedule 80 Harvel® PVC

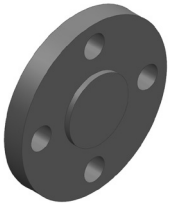

- ANSI 150 Class according to ANSI B16.5
  - 1/2" - 8" 150 psi @ 73°F (10.3 bar @ 22.7°C)
  - 10" - 24" 50 psi @ 73°F (3.5 bar @ 22.7°C)
- HC = Honeycomb (Face)

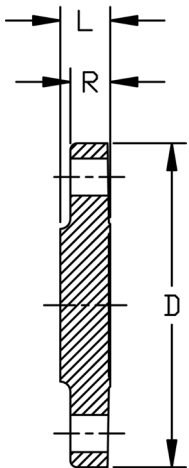

Size (inch)	P/L	Part No.	Pack Qty	# holes	Bolt Dia. (inch)	bolt cir. dia. (inch)	D (inch)	L (inch)	R (inch)	Design
1/2	608	853-005	5	4	1/2	2.38	3.51	0.48	0.39	HC
3/4	608	853-007	5	4	1/2	2.75	3.90	0.55	0.45	HC
1	608	853-010	5	4	1/2	3.13	4.29	0.66	0.53	HC
1 1/4	608	853-012	5	4	1/2	3.50	4.62	0.73	0.59	HC
1 1/2	608	853-015	5	4	1/2	3.88	5.01	0.81	0.68	HC
2	608	853-020	5	4	3/4	4.75	6.02	0.90	0.70	HC
2 1/2	608	853-025	5	4	3/4	5.50	7.00	0.97	0.76	HC
3	608	853-030	5	4	3/4	6.00	7.45	1.03	1.03	HC
4	608	853-040	5	8	3/4	7.50	8.96	1.14	1.14	HC
6	608	853-060	2	8	3/4	9.50	10.95	1.51	1.27	HC
8	608	853-080	2	8	3/4	11.75	13.51	1.62	1.45	HC
10	A33	853-100N	1	12	7/8	14.25	16.00	1.00	1.00	SOLID
12	A33	853-120N	1	12	7/8	17.00	19.00	1.00	1.00	SOLID
14	A33	853-140N	1	12	1	18.75	21.00	1.00	1.00	SOLID
16	A33	853-160N	1	16	1	21.25	23.50	1.00	1.00	SOLID
18	A33	853-180N	1	16	1 1/4	22.75	25.00	1.00	1.00	SOLID
20	A33	853-200N	1	20	1 1/4	25.00	27.50	1.00	1.00	SOLID
24	A33	853-240N	1	20	1 1/4	29.50	32.00	1.00	1.00	SOLID

### Flange - Van Stone 300 (S) Schedule 80 Harvel® PVC

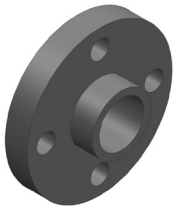

- ANSI 300 Class according to ANSI B16.5
- 150 psi @ 73°F (10.3 bar @ 22.7°C)

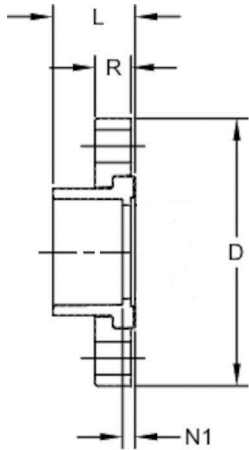

Size (inch)	P/L	Part No.	Pack Qty	# holes	Bolt Dia. (inch)	bolt cir. dia. (inch)	D (inch)	L (inch)	N1 (inch)	R (inch)	Design
½	608	<b>854-005-300</b>	5	4	½	2.63	3.75	1.03	0.11	0.57	FAB
¾	608	<b>854-007-300</b>	5	4	¾	3.25	4.63	1.15	0.13	0.59	FAB
1	608	<b>854-010-300</b>	5	4	¾	3.50	4.88	1.38	0.11	0.66	FAB
1 ¼	608	<b>854-012-300</b>	5	4	¾	3.88	5.25	1.45	0.14	0.69	FAB
1 ½	608	<b>854-015-300</b>	5	4	¾	4.50	6.13	1.59	0.15	0.75	FAB
2	608	<b>854-020-300</b>	5	8	¾	5.00	6.50	1.76	0.20	0.82	FAB
2 ½	608	<b>854-025-300</b>	5	8	¾	5.88	7.50	2.05	0.22	0.98	FAB
3	608	<b>854-030-300</b>	5	8	¾	6.63	8.25	2.25	0.30	1.02	FAB
4	608	<b>854-040-300</b>	5	8	¾	7.88	10.00	2.65	0.34	1.10	FAB
6	608	<b>854-060-300</b>	2	12	¾	10.63	12.50	3.45	0.35	1.25	FAB
8	608	<b>854-080-300</b>	2	12	¾	13.00	15.00	4.50	0.40	1.71	FAB
10	602	<b>854-100-300</b>	2	16	1	15.25	17.50	5.63	0.50	1.73	FAB
12	602	<b>854-120-300</b>	2	16	1 ½	17.75	20.50	6.69	0.56	1.72	FAB

### Union Type 375 (S x S) Schedule 80 Harvel® PVC

235 psi @ 73°F (16.2 bar @ 22.7°C)

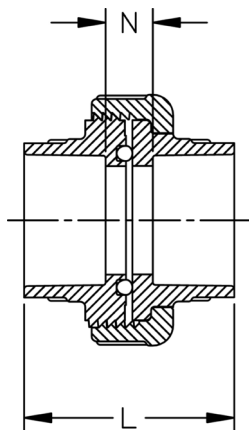

Size (inch)	P/L	EPDM Part No.	FKM Part No.	Pack Qty	L (inch)	N (inch)
½	608	<b>897-375-005</b>	<b>857-375-005</b>	5	2.56	0.78
¾	608	<b>897-375-007</b>	<b>857-375-007</b>	5	2.80	0.76
1	608	<b>897-375-010</b>	<b>857-375-010</b>	5	3.22	0.89
1 ¼	608	<b>897-375-012</b>	<b>857-375-012</b>	5	3.56	0.99
1 ½	608	<b>897-375-015</b>	<b>857-375-015</b>	5	3.76	0.92
2	608	<b>897-375-020</b>	<b>857-375-020</b>	2	4.18	1.11





### Union (S x S) Schedule 80 Harvel® PVC

150 psi @ 73°F (10.3 bar @ 22.7°C)

Size (inch)	P/L	EPDM Part No.	FKM Part No.	Pack Qty	L (inch)	N (inch)
3	608	897-030	857-030	1	4.74	0.96
4	608	897-040	857-040	1	5.62	1.11

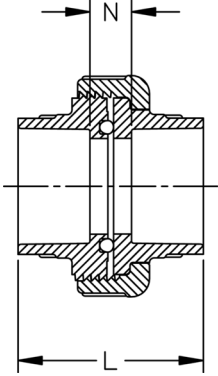

### Union Type 375 (FPT X FPT) Schedule 80 Harvel® PVC

• 235 psi @ 73°F (16.2 bar @ 22.7°C)

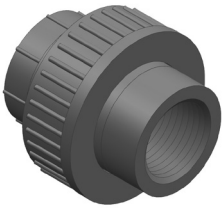

Size (inch)	P/L	EPDM Part No.	FKM Part No.	Pack Qty	L (inch)	T (inch)
½	608	898-375-005	858-375-005	5	2.06	0.75
¾	608	898-375-007	858-375-007	5	2.11	0.79
1	608	898-375-010	858-375-010	5	2.60	1.01
1 ¼	608	898-375-012	858-375-012	5	2.80	1.06
1 ½	608	898-375-015	858-375-015	5	2.76	1.06
2	608	898-375-020	858-375-020	2	2.93	1.09

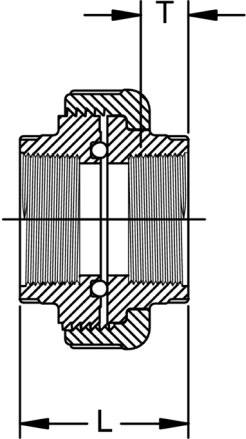



### Union (FPT X FPT) Schedule 80 Harvel® PVC

- 150 psi @ 73°F (10.3 bar @ 22.7°C)

Size (inch)	P/L	EPDM Part No.	FKM Part No.	Pack Qty	L (inch)	T (inch)
3	608	<b>898-030</b>	<b>858-030</b>	1	4.75	1.33
4	608	<b>898-040</b>	<b>858-040</b>	1	5.71	1.78

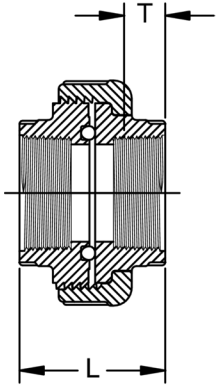

### Nipple (MPT x MPT) Schedule 80 Harvel® PVC

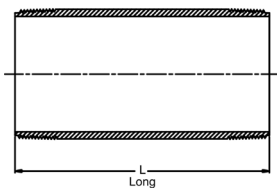
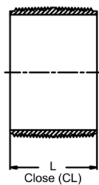
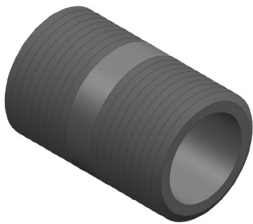

Size (inch)	P/L	Part No.	Pack Qty	L (inch)	Design
1/2 x CL	608	<b>861-077</b>	50	1.13	MOLD
1/2 x 2	608	<b>861-079</b>	25	2.00	MOLD
1/2 x 3	608	<b>861-081</b>	25	3.00	MOLD
1/2 x 4	608	<b>861-082</b>	25	4.00	MOLD
1/2 x 5	608	<b>861-083</b>	25	5.00	MOLD
1/2 x 6	608	<b>861-084</b>	25	6.00	MOLD
1/2 x 8	608	<b>861-086</b>	25	8.00	FAB
1/2 x 10	608	<b>861-087</b>	25	10.00	FAB
1/2 x 12	608	<b>861-088</b>	25	12.00	FAB
3/4 x CL	608	<b>861-104</b>	25	1.38	MOLD
3/4 x 2	608	<b>861-020</b>	25	2.00	MOLD
3/4 x 3	608	<b>861-106</b>	25	3.00	MOLD
3/4 x 4	608	<b>861-107</b>	25	4.00	MOLD
3/4 x 5	608	<b>861-108</b>	25	5.00	MOLD
3/4 x 6	608	<b>861-109</b>	25	6.00	MOLD
3/4 x 8	608	<b>861-110</b>	25	8.00	FAB
3/4 x 10	608	<b>861-111</b>	25	10.00	FAB
3/4 x 12	608	<b>861-112</b>	25	12.00	FAB
1 x CL	608	<b>861-133</b>	25	1.50	MOLD
1 x 2	608	<b>861-134</b>	25	2.00	MOLD
1 x 3	608	<b>861-135</b>	25	3.00	MOLD
1 x 4	608	<b>861-136</b>	25	4.00	MOLD
1 x 5	608	<b>861-137</b>	25	5.00	MOLD
1 x 6	608	<b>861-138</b>	25	6.00	MOLD
1 x 8	608	<b>861-139</b>	25	8.00	FAB
1 x 10	608	<b>861-140</b>	25	10.00	FAB
1 x 12	608	<b>861-141</b>	25	12.00	FAB
1 1/4 x CL	608	<b>861-170</b>	25	1.63	MOLD
1 1/4 x 2	608	<b>861-171</b>	25	2.00	MOLD
1 1/4 x 3	608	<b>861-172</b>	25	3.00	MOLD
1 1/4 x 4	608	<b>861-173</b>	25	4.00	MOLD
1 1/4 x 5	608	<b>861-174</b>	25	5.00	MOLD

table continued on the next page

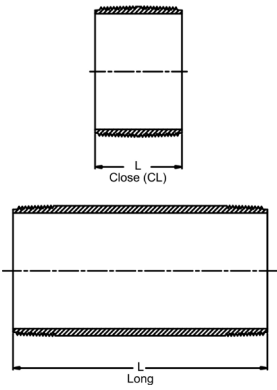

Size (inch)	P/L	Part No.	Pack Qty	L (inch)	Design
1 1/4 x 6	608	<b>861-175</b>	25	6.00	MOLD
1 1/4 x 8	608	<b>861-176</b>	25	8.00	FAB
1 1/4 x 10	608	<b>861-177</b>	25	10.00	FAB
1 1/4 x 12	608	<b>861-178</b>	25	12.00	FAB
1 1/2 x CL	608	<b>861-213</b>	25	1.75	MOLD
1 1/2 x 2	608	<b>861-214</b>	25	2.00	MOLD
1 1/2 x 3	608	<b>861-215</b>	25	3.00	MOLD
1 1/2 x 4	608	<b>861-216</b>	25	4.00	MOLD
1 1/2 x 5	608	<b>861-217</b>	25	5.00	MOLD
1 1/2 x 6	608	<b>861-218</b>	25	6.00	MOLD
1 1/2 x 8	608	<b>861-219</b>	25	8.00	FAB
1 1/2 x 10	608	<b>861-220</b>	25	10.00	FAB
1 1/2 x 12	608	<b>861-221</b>	25	12.00	FAB
2 x CL	608	<b>861-251</b>	25	2.00	MOLD
2 x 2 1/2	608	<b>861-252</b>	25	2.50	MOLD
2 x 3	608	<b>861-253</b>	25	3.00	MOLD
2 x 4	608	<b>861-254</b>	25	4.00	MOLD
2 x 5	608	<b>861-255</b>	25	5.00	MOLD
2 x 6	608	<b>861-256</b>	25	6.00	MOLD
2 x 8	608	<b>861-257</b>	25	8.00	FAB
2 x 10	608	<b>861-258</b>	25	10.00	FAB
2 x 12	608	<b>861-259</b>	25	12.00	FAB
2 1/2 x CL	608	<b>861-291</b>	10	2.50	FAB
2 1/2 x 4	608	<b>861-295</b>	10	4.00	FAB
2 1/2 x 3	608	<b>861-292</b>	10	3.00	FAB
2 1/2 x 5	608	<b>861-296</b>	10	5.00	FAB
2 1/2 x 6	608	<b>861-297</b>	10	6.00	FAB
2 1/2 x 8	608	<b>861-298</b>	10	8.00	FAB
2 1/2 x 10	608	<b>861-299</b>	10	10.00	FAB
2 1/2 x 12	608	<b>861-300</b>	10	12.00	FAB
3 x CL	608	<b>861-338</b>	10	2.63	FAB
3 x 3	608	<b>861-340</b>	10	3.00	FAB
3 x 4	608	<b>861-341</b>	10	4.00	FAB
3 x 5	608	<b>861-342</b>	10	5.00	FAB
3 x 6	608	<b>861-343</b>	10	6.00	FAB
3 x 8	608	<b>861-344</b>	10	8.00	FAB
3 x 10	608	<b>861-345</b>	10	10.00	FAB
3 x 12	608	<b>861-346</b>	10	12.00	FAB
4 x CL	608	<b>861-422</b>	10	2.88	FAB
4 x 4	608	<b>861-423</b>	10	4.00	FAB
4 x 5	608	<b>861-425</b>	10	5.00	FAB
4 x 6	608	<b>861-426</b>	10	6.00	FAB
4 x 8	608	<b>861-427</b>	5	8.00	FAB
4 x 10	608	<b>861-428</b>	5	10.00	FAB
4 x 12	608	<b>861-429</b>	5	12.00	FAB

# Schedule 80 PVC Low Pressure Fittings



## Tee Low Pressure (SxSxS) Schedule 80 Harvel<sup>®</sup> PVC

- 130 psi @ 73°F (8.96 bar @ 22.7°C)

Size (inch)	P/L	Part No.	Pack Qty	H (inch)	G (inch)
10	B11	H801100LP	1	10.83	5.77
12	B11	H801120LP	1	13.38	6.91

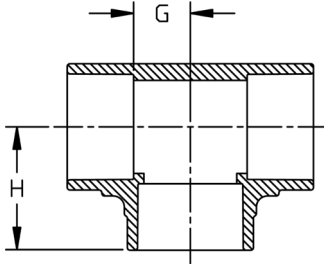

## 90° Ell Low Pressure (S x S) Schedule 80 Harvel<sup>®</sup> PVC

- 130 psi @ 73°F (8.96 bar @ 22.7°C)



Size (inch)	P/L	Part No.	Pack Qty	H (inch)	G (inch)
10	B11	H806100LP	1	10.75	5.75
12	B11	H806120LP	1	12.96	6.91

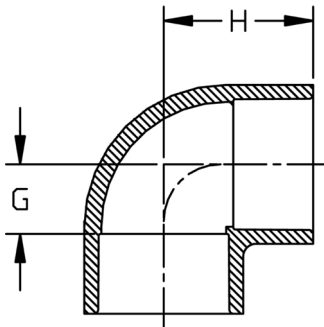

**45° Ell Low Pressure (S x S) Schedule 80 Harvel® PVC**



- 130 psi @ 73°F (8.96 bar @ 22.7°C)

Size (inch)	P/L	Part No.	Pack Qty	H (inch)	J (inch)
10	B11	<b>H817100LP</b>	1	7.50	2.50
12	B11	<b>H817120LP</b>	1	9.00	3.00

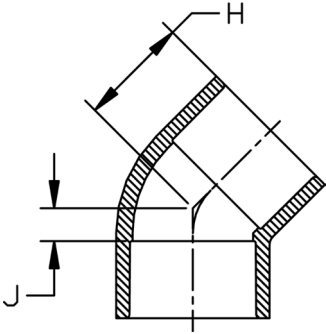

**Coupling Low Pressure (S x S) Schedule 80 Harvel® PVC**



- 130 psi @ 73°F (8.96 bar @ 22.7°C)

Size (inch)	P/L	Part No.	Pack Qty	L (inch)	N (inch)
10	B11	<b>H829100LP</b>	1	10.81	0.75
12	B11	<b>H829120LP</b>	1	12.81	0.75

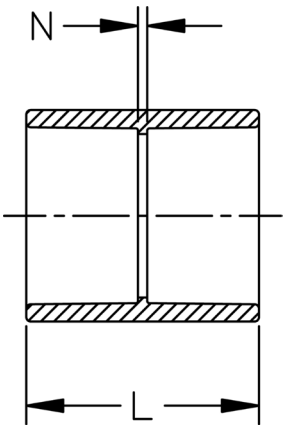



# Schedule 80 PVC DWV Fittings



## 1/4 Bend Short Sweep (SxS) Schedule 80 Harvel® PVC

Size (inch)	P/L	Part No.	Pack Qty	G (inch)
1 1/2	608	<b>806-015SS</b>	4	1.75
2	608	<b>806-020SS</b>	4	2.31
3	608	<b>806-030SS</b>	1	3.06
4	608	<b>806-040SS</b>	1	3.88

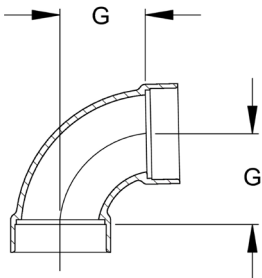

## 1/4 Bend Long Sweep (SxS) - (FAB) Schedule 80 Harvel® PVC



Size (inch)	P/L	Part No.	Pack Qty	G (inch)
1 1/2	A33	<b>806-015LSN</b>	4	4.13
2	A33	<b>806-020LSN</b>	4	4.75
3	A33	<b>806-030LSN</b>	1	7.00
4	A33	<b>806-040LSN</b>	1	9.00

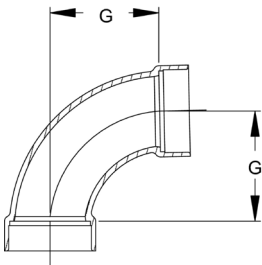

## 45° Wye (S x S x S) Schedule 80 Harvel® PVC

1-1/2" - 2" 235 psi @ 72°F (16.2 bar @ 22.7°C)  
 3" - 6" 150 psi @ 72°F (10.3 bar @ 22.7°C)  
 8" - 24" 100 psi @ 72°F (6.9 bar @ 22.7°C)



Size (inch)	P/L	Part No.	Pack Qty	GJ (inch)	GN (inch)	H (inch)	HJ (inch)	L (inch)	N (inch)	Design
1 1/2	608	<b>870-015</b>	20	2.79	1.20	2.60	4.18	6.80	4.02	SL
2	608	<b>870-020</b>	10	3.56	1.36	2.87	5.07	7.99	4.97	SL
2 1/2	H02	<b>870-025S</b>	1	3.97	0.84	2.59	5.72	8.31	3.97	SL
3	608	<b>870-030</b>	4	4.91	1.82	3.73	6.83	10.45	6.62	SL
4	608	<b>870-040</b>	4	6.26	2.06	4.41	8.61	12.94	8.24	SL
6	608	<b>870-060</b>	2	8.38	1.85	4.90	11.44	16.50	10.39	HS
8	608	<b>870-080</b>	1	11.09	1.90	5.92	15.11	21.35	13.30	HS
10	A33	<b>875-100N</b>	1	19.75	5.50	11.25	24.75	31.75	21.75	FAB
12	A33	<b>875-120N</b>	1	22.63	6.50	12.50	28.63	37.50	25.50	FAB
14	A33	<b>875-140N</b>	1	25.75	7.00	14.00	32.75	41.75	27.75	FAB

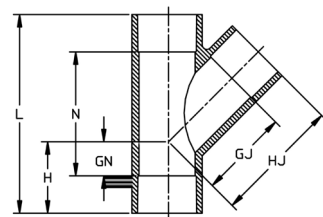
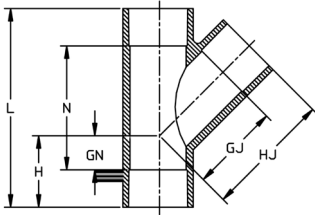

table continued on the next page



Size (inch)	P/L	Part No.	Pack Qty	GJ (inch)	GN (inch)	H (inch)	HJ (inch)	L (inch)	N (inch)	Design
16	A33	<b>875-160N</b>	1	28.88	7.75	16.00	36.88	47.25	31.25	FAB
18	A33	<b>875-180N</b>	1	32.50	8.50	17.50	41.50	53.00	35.00	FAB
20	A33	<b>875-200N</b>	1	35.50	9.50	19.50	45.50	58.75	38.75	FAB
24	A33	<b>875-240N</b>	1	42.00	11.00	23.00	54.00	70.00	46.00	FAB

### Reducing 45° Wye (S x S x S) Schedule 80 Harvel® PVC

2" 235 psi @ 72°F (16.2 bar @ 22.7° C)  
 3" - 6" 150 psi @ 72°F (10.3 bar @ 22.7°C)  
 8" - 24" 100 psi @ 72°F (6.9 bar @ 22.7°C)

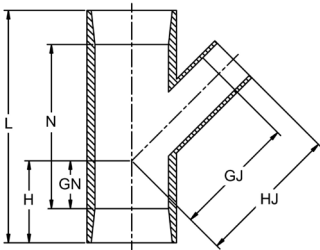

Size (inch)	P/L	Part No.	Pack Qty	GJ (inch)	GN (inch)	H (inch)	HJ (inch)	L (inch)	N (inch)	Design
2 x 1 1/2	608	<b>870-251FB</b>	10	3.96	1.36	2.87	5.37	7.99	4.97	BUSH
3 x 1 1/2	608	<b>870-337FB</b>	4	5.80	1.82	3.73	7.34	10.45	6.62	BUSH
3 x 2	608	<b>870-338FB</b>	4	5.77	1.82	3.73	7.33	10.45	6.62	BUSH
4 x 2	608	<b>870-420FB</b>	4	7.40	2.06	4.41	7.40	12.94	8.24	BUSH
4 x 3	608	<b>870-422FB</b>	4	7.03	2.06	4.41	9.00	12.94	8.24	BUSH
6 x 2	608	<b>870-528FB</b>	2	8.24	1.87	4.91	8.24	16.49	10.42	BUSH
6 x 3	608	<b>870-530FB</b>	2	7.88	1.87	4.91	9.84	16.49	10.42	BUSH
6 x 4	608	<b>870-532</b>	2	7.14	1.87	4.91	9.36	16.49	10.42	HS
8 x 3	608	<b>870-580FB</b>	1	10.23	0.41	4.43	12.20	15.98	7.95	BUSH
8 x 4	608	<b>870-582</b>	1	9.46	0.41	4.43	11.73	15.98	7.95	HS
8 x 6	608	<b>870-585FB</b>	1	12.78	1.90	5.92	15.76	21.35	13.30	BUSH
10 x 4	A33	<b>875-623N</b>	1	14.00	1.25	6.25	16.00	23.00	13.00	FAB
10 x 6	A33	<b>875-626N</b>	1	16.13	2.75	7.50	19.13	26.00	16.00	FAB
10 x 8	A33	<b>875-628N</b>	1	17.50	4.00	9.25	21.50	28.00	18.75	FAB
12 x 4	A33	<b>875-663N</b>	1	15.50	0.50	6.00	17.50	25.75	13.75	FAB
12 x 6	A33	<b>875-666N</b>	1	16.68	2.00	8.00	20.50	28.68	16.68	FAB
12 x 8	A33	<b>875-668N</b>	1	19.00	3.50	9.50	23.00	31.50	19.50	FAB
12 x 10	A33	<b>875-670N</b>	1	21.25	5.00	11.00	26.25	34.50	22.50	FAB
14 x 4	A33	<b>875-696N</b>	1	16.25	0.25	7.25	18.25	28.25	14.25	FAB
14 x 6	A33	<b>875-698N</b>	1	18.50	1.75	8.63	21.50	31.25	17.25	FAB
14 x 8	A33	<b>875-700N</b>	1	19.75	3.00	10.00	23.75	34.00	20.00	FAB
14 x 10	A33	<b>875-702N</b>	1	22.00	4.50	11.50	27.00	37.00	23.00	FAB
14 x 12	A33	<b>875-704N</b>	1	23.50	6.00	13.00	29.50	39.75	25.75	FAB
16 x 4	A33	<b>875-730N</b>	1	17.75	-0.75	7.50	19.75	31.00	15.00	FAB
16 x 6	A33	<b>875-732N</b>	1	19.88	1.00	9.00	22.88	34.00	18.00	FAB
16 x 8	A33	<b>875-734N</b>	1	21.25	2.50	10.25	25.25	36.75	20.75	FAB
16 x 10	A33	<b>875-736N</b>	1	23.50	4.00	12.00	28.50	39.75	23.75	FAB
16 x 12	A33	<b>875-738N</b>	1	25.00	5.50	14.25	31.00	42.75	26.75	FAB
16 x 14	A33	<b>875-740N</b>	1	27.25	6.25	14.25	34.25	44.50	28.50	FAB
18 x 4	A33	<b>875-784N</b>	1	19.00	-1.25	8.00	21.00	34.00	16.00	FAB
18 x 6	A33	<b>875-786N</b>	1	21.25	0.50	9.50	24.25	37.00	19.00	FAB
18 x 8	A33	<b>875-788N</b>	1	22.75	2.00	11.00	26.75	39.75	21.75	FAB
18 x 10	A33	<b>875-790N</b>	1	25.00	3.50	12.50	30.00	42.75	24.75	FAB
18 x 12	A33	<b>875-792N</b>	1	26.25	4.75	13.75	32.50	45.50	27.50	FAB
18 x 14	A33	<b>875-794N</b>	1	28.75	5.75	14.75	35.75	47.50	29.50	FAB
18 x 16	A33	<b>875-796N</b>	1	30.25	7.25	16.00	38.25	50.25	32.25	FAB
20 x 4	A33	<b>875-814N</b>	1	20.50	-1.75	8.50	22.50	36.75	16.75	FAB
20 x 6	A33	<b>875-816N</b>	1	22.75	-0.25	10.00	25.75	39.75	19.75	FAB
20 x 8	A33	<b>875-818N</b>	1	24.25	1.50	11.50	28.25	42.75	22.75	FAB
20 x 10	A33	<b>875-820N</b>	1	26.50	3.00	13.00	31.50	45.75	25.75	FAB
20 x 12	A33	<b>875-822N</b>	1	28.00	4.25	14.25	34.00	48.50	28.50	FAB
20 x 14	A33	<b>875-824N</b>	1	30.25	5.25	15.00	37.25	50.25	30.25	FAB
20 x 16	A33	<b>875-826N</b>	1	31.75	6.50	16.50	39.75	53.00	33.00	FAB
20 x 18	A33	<b>875-828N</b>	1	34.00	8.00	18.00	43.00	56.00	36.00	FAB
24 x 4	A33	<b>875-904N</b>	1	23.25	-3.00	9.25	25.25	42.50	18.50	FAB
24 x 6	A33	<b>875-906N</b>	1	25.50	-1.50	10.75	28.50	45.50	21.54	FAB

table continued on the next page

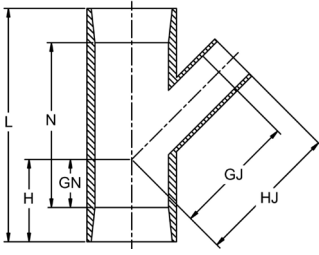

Size (inch)	P/L	Part No.	Pack Qty	GJ (inch)	GN (inch)	H (inch)	HJ (inch)	L (inch)	N (inch)	Design
24 x 8	A33	<b>875-908N</b>	1	27.00	0.00	12.00	31.00	48.25	24.25	FAB
24 x 10	A33	<b>875-910N</b>	1	29.25	1.75	13.50	34.25	51.25	27.25	FAB
24 x 12	A33	<b>875-912N</b>	1	30.50	3.25	15.00	36.50	54.25	30.25	FAB
24 x 14	A33	<b>875-914N</b>	1	33.00	4.00	16.00	40.00	56.00	32.00	FAB
24 x 16	A33	<b>875-916N</b>	1	34.50	5.50	17.50	42.50	58.75	34.75	FAB
24 x 18	A33	<b>875-918N</b>	1	36.75	6.75	18.75	45.75	61.50	37.50	FAB
24 x 20	A33	<b>875-920N</b>	1	38.25	8.25	20.25	48.25	64.50	40.50	FAB

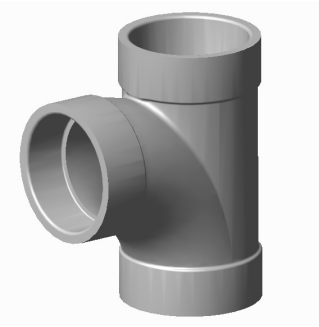

### Sanitary Tee (SxSxS) Schedule 80 Harvel® PVC

Size (inch)	P/L	Part No.	Pack Qty	G (inch)	N (inch)
1 1/2	608	<b>37R461501</b>	5	1.75	2.75
2	608	<b>37R461502</b>	5	2.31	3.69
3	608	<b>37R461503</b>	5	3.06	4.88
4	608	<b>37R461504</b>	5	3.88	6.13

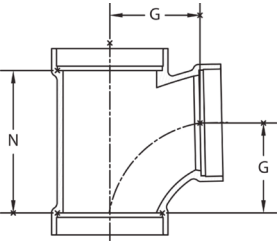

### Cleanout Tee with Plug (SxSxFPT) Schedule 80 Harvel® PVC

Size (inch)	P/L	Part No.	Pack Qty	HL (inch)	N (inch)
1 1/2	608	<b>37R461101</b>	2	2.07	1.80
2	608	<b>37R461102</b>	2	2.35	2.32
3	608	<b>37R461103</b>	2	3.51	3.63
4	608	<b>37R461104</b>	2	4.07	4.25

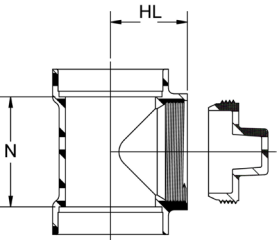

# Schedule 80 PVC Metal Transition Fittings

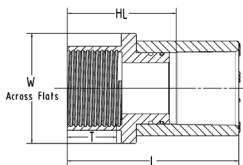
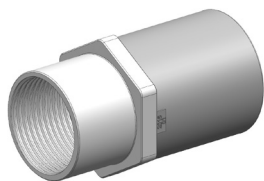

## PVC-to-316SS Female Adapter (SxFPT) Schedule 80 Harvel® PVC

- 150 psi @ 73°F (10.3 bar @ 22.7°C)

Size (inch)	P/L	Part No.	Pack Qty	HL (inch)	L (inch)	T (inch)	W (inch)
½	A35	<b>868-005SS</b>	10	1.49	2.38	0.84	1.25
¾	A35	<b>868-007SS</b>	10	1.67	2.68	0.92	1.50
1	A35	<b>868-010SS</b>	6	1.98	3.11	0.96	1.75
1 ¼	A35	<b>868-012SS</b>	5	2.19	3.45	1.04	2.12
1 ½	A35	<b>868-015SS</b>	5	2.35	3.73	1.04	2.50
2	A35	<b>868-020SS</b>	4	2.63	4.14	1.29	3.00

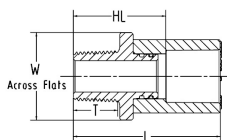
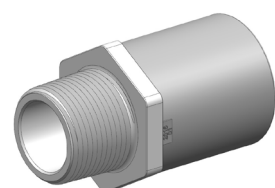

## PVC-to-316SS Male Adapter (SxMPT) Schedule 80 Harvel® PVC

- 150 psi @ 73°F (10.3 bar @ 22.7°C)

Size (inch)	P/L	Part No.	Pack Qty	HL (inch)	L (inch)	T (inch)	W (inch)
½	A35	<b>869-005SS</b>	10	1.49	2.38	0.70	1.25
¾	A35	<b>869-007SS</b>	10	1.67	2.68	0.74	1.50
1	A35	<b>869-010SS</b>	6	1.98	3.11	0.92	1.75
1 ¼	A35	<b>869-012SS</b>	5	2.19	3.45	0.95	2.12
1 ½	A35	<b>869-015SS</b>	5	2.35	3.73	0.99	2.50
2	A35	<b>869-020SS</b>	4	2.64	4.14	1.03	3.00

## Metal Union End Connectors Type 375 (316 SS)

150 psi @ 73°F (10.3 bar @ 22.7°C)  
Union Sold Separately



Size (inch)	P/L	Part No.	Pack Qty
½	A35	<b>37X003314</b>	1
¾	A35	<b>37X003315</b>	1
1	A35	<b>37X003316</b>	1
1 ¼	A35	<b>37X003317</b>	1
1 ½	A35	<b>37X003318</b>	1
2	A35	<b>37X003319</b>	1

**PVC-to-Brass Transition Fittings (SPG x FPT) Schedule 80 Harvel® PVC**

150 psi @ 73°F (10.3 bar @ 22.7°C)

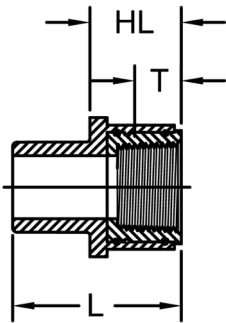
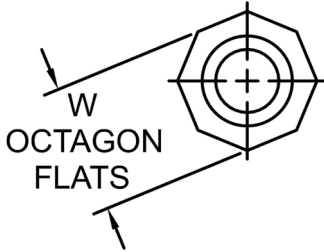
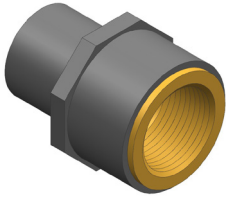

Size (inch)	P/L	Part No.	Pack Qty	HL (inch)	L (inch)	T (inch)	W (inch)
½	A35	<b>878-005BR</b>	25	1.02	1.75	0.70	1.27
¾	A35	<b>878-007BR</b>	15	1.07	2.07	0.74	1.52
1	A35	<b>878-010BR</b>	15	1.32	2.44	0.81	1.93
1 ¼	A35	<b>878-012BR</b>	15	1.38	2.49	0.85	2.29
1 ½	A35	<b>878-015BR</b>	10	1.44	2.74	0.87	2.60
2	A35	<b>878-020BR</b>	5	1.43	2.81	1.11	3.36

**PVC-to-316 SS Transition Fittings (SPG x FPT) Schedule 80 Harvel® PVC**

150 psi @ 73°F (10.3 bar @ 22.7°C)

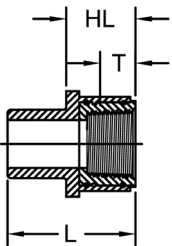
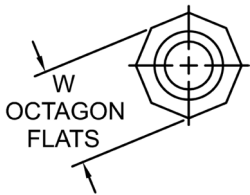
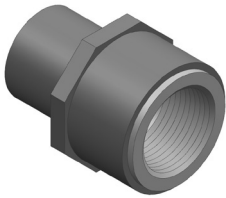

Size (inch)	P/L	Part No.	Pack Qty	HL (inch)	L (inch)	T (inch)	W (inch)
½	A35	<b>878-005SS</b>	25	1.02	1.75	0.70	1.27
¾	A35	<b>878-007SS</b>	15	1.07	2.07	0.74	1.52
1	A35	<b>878-010SS</b>	15	1.32	2.44	0.81	1.93
1 ¼	A35	<b>878-012SS</b>	15	1.38	2.49	0.85	2.29
1 ½	A35	<b>878-015SS</b>	10	1.45	2.74	0.87	2.60
2	A35	<b>878-020SS</b>	5	1.43	2.81	1.11	3.36

# Schedule 80 PVC Expansion Joints

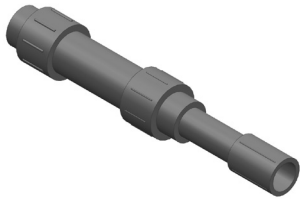

## Expansion Joint 6" Travel (S x S) Schedule 80 Harvel® PVC

To order SxSPG add "P" to end of part number.  
To order FxF add "F" to end of part number.

Size (inch)	P/L	EPDM Part No.	FKM Part No.	A (inch)	D (inch)	L (inch)	N (inch)
½	634	826-005X6	836-005X6	3.00	1.86	13.97	12.17
¾	634	826-007X6	836-007X6	3.00	2.23	14.44	12.40
1	634	826-010X6	836-010X6	3.00	2.50	14.98	12.69
1 ¼	634	826-012X6	836-012X6	3.00	2.89	15.56	12.98
1 ½	634	826-015X6	836-015X6	3.00	3.51	16.00	13.21
2	634	826-020X6	836-020X6	3.00	4.40	18.05	15.01
3	634	826-030X6	836-030X6	3.00	5.52	19.75	16.00
4	634	826-040X6	836-040X6	3.00	7.92	28.29	23.76
6	634	826-060X6	836-060X6	3.00	9.80	27.79	21.73
8	634	826-080X6	836-080X6	3.00	10.75	25.35	17.31
10	634	826-100X6	836-100X6	3.00	12.75	29.64	19.60

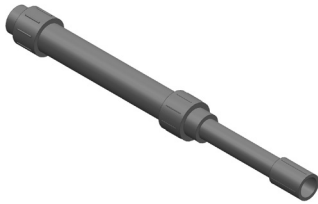
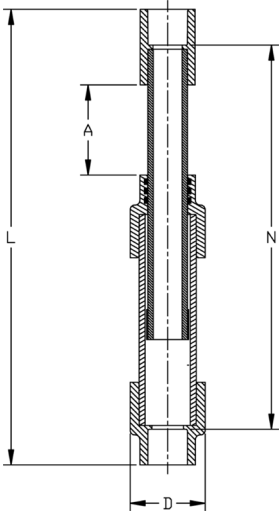

## Expansion Joint 12" Travel (S x S) Schedule 80 Harvel® PVC

To order SxSPG add "P" to end of part number.  
To order FxF add "F" to end of part number.

Size (inch)	P/L	EPDM Part No.	FKM Part No.	A (inch)	D (inch)	L (inch)	N (inch)
½	634	826-005X12	836-005X12	6.00	1.86	23.10	21.30
¾	634	826-007X12	836-007X12	6.00	2.23	23.57	21.52
1	634	826-010X12	836-010X12	6.00	2.50	24.11	21.81
1 ¼	634	826-012X12	836-012X12	6.00	2.89	24.69	22.11
1 ½	634	826-015X12	836-015X12	6.00	3.51	25.12	22.34
2	634	826-020X12	836-020X12	6.00	4.40	27.05	24.01
3	634	826-030X12	836-030X12	6.00	5.52	28.75	25.00
4	634	826-040X12	836-040X12	6.00	7.92	37.28	32.76
6	634	826-060X12	836-060X12	6.00	9.80	26.79	30.73
8	634	826-080X12	836-080X12	6.00	10.75	28.35	20.31
10	634	826-100X12	836-100X12	6.00	12.75	32.64	22.60

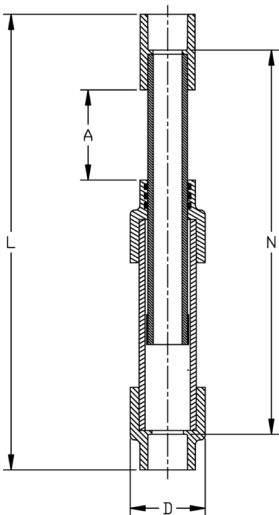



**Section 2**

**Schedule 40 and  
ChlorFIT® Schedule 80  
CPVC Piping Systems**

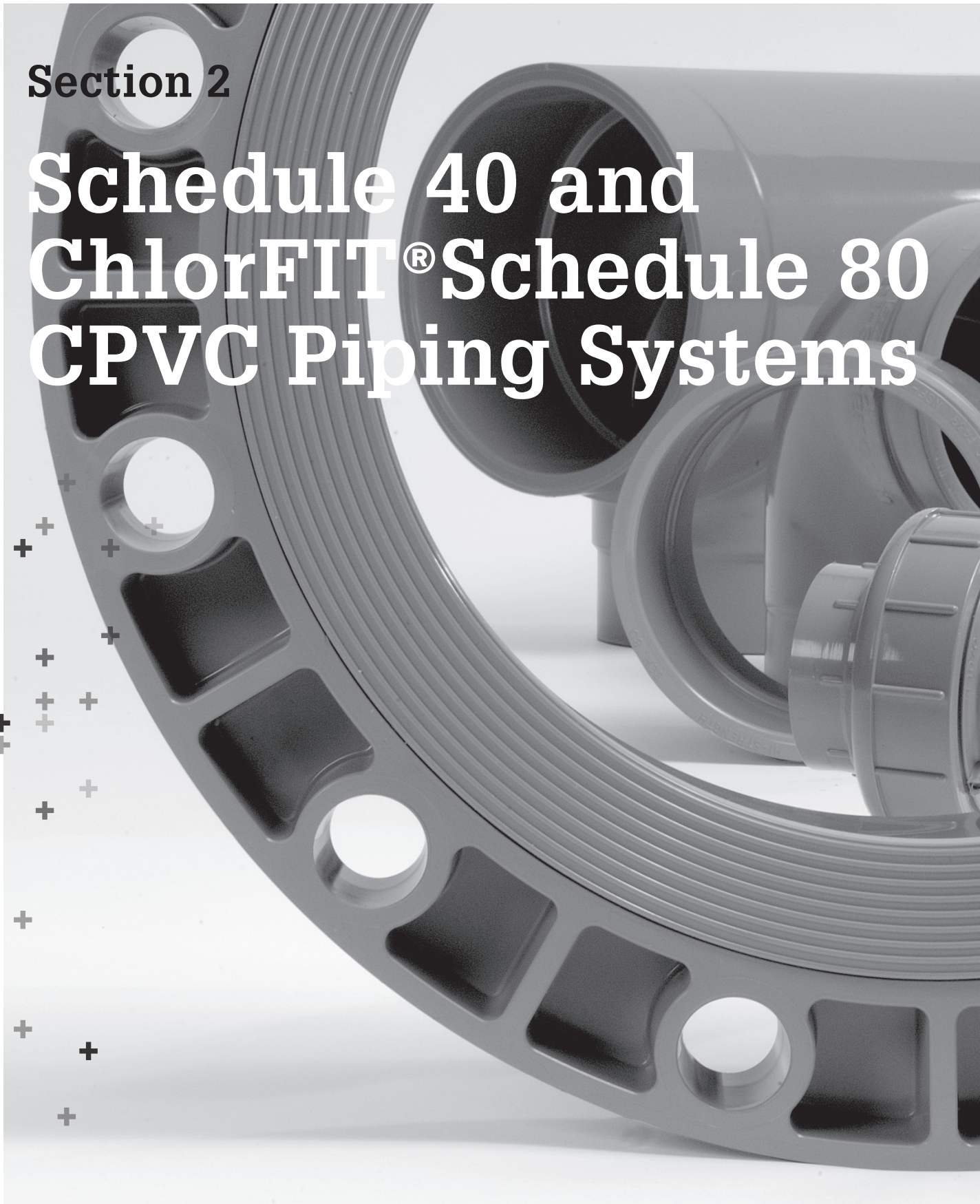

## Glossary

<b>FPT</b>	=	<b>Female Pipe Thread</b>
<b>MPT</b>	=	<b>Male Pipe Thread</b>
<b>S</b>	=	<b>Tapered Socket</b>
<b>SPG</b>	=	<b>Spigot End (same dimension as pipe outside diameter)</b>
<b>*</b>	=	<b>Non-Returnable / Non-cancellable</b>
<b>^</b>	=	<b>40% Restocking Fee</b>
<b>HS</b>	=	<b>High Strength Design</b>
<b>SL</b>	=	<b>Streamline Design</b>
<b>BUSH</b>	=	<b>Assembled Fitting from Molded Components</b>
<b>FAB</b>	=	<b>Fabricated Fitting</b>

The technical information given in this publication implies no warranty of any kind and is subject to change without notice. Please consult our Terms and Conditions of Sale.

For complete technical information, please consult the Vinyl Catalog and Technical Information

**For more information about any of our product lines, please visit [www.gfps.com](http://www.gfps.com)**



Schedule 40 CPVC Pressure Pipe

145

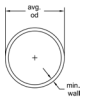

ChlorFIT® Schedule 80 CPVC Pressure Pipe

146



ChlorFIT® Schedule 80 CPVC Pressure Fittings

147



ChlorFIT® Schedule 80 CPVC DWV Fittings

167



ChlorFIT® Schedule 80 CPVC Metal Transition Fittings

170



ChlorFIT® Schedule 80 CPVC Expansion Joints

173

# Specifications, Standards and Tolerances

## Specifications and Standards

NSF/ANSI Standard 14

NSF/ANSI Standard 61

ASTM D 1784 : Material CPVC Type IV, Grade I Gray (cell classification 23447) – Pipe & Fittings

ASTM F 441 : CPVC Schedule 40 and Schedule 80 Pipe

ASTM F 439 : CPVC Schedule 80 Socket & Threaded Fittings

ASTM F 437 : CPVC Schedule 80 Threaded Fittings

ASTM F 1970 : CPVC Schedule 80 Unions

ANSI B16.5 : Flange Bolt Hole Patterns

ANSI B1.20.1 : CPVC Schedule 80 NPT Threads

CSA B137.6 : CPVC Schedule 80 Pipe (1¼"–2½" only)

ULC S102.2 : CPVC Schedule 40 Pipe (½"–24"); Schedule 80 Pipe (½"–12")

## Molded Dimension Tolerances

A Piston Position; Expansion Joints :  $\pm 0.03$

D Outside Diameter :  $\pm 0.06$

G, G1 Intersections of centerlines to bottom of socket; 90° Ells, Tees : up to 4"  $\pm 0.03$ ; 6" and above  $\pm 0.06$

GJ, GN Intersections of centerlines to bottom of socket; 45° Wyes : up to 4"  $\pm 0.03$ ; 6" and above  $\pm 0.06$

H, HJ, HN Intersections of centerlines to face of fitting; 90° Ells, 45° Ells, Tees, 45° Wyes : up to 4"  $\pm 0.03$ ; 6" and above  $\pm 0.06$

HL Socket Bottom to Face of Fitting : up to 4"  $\pm 0.03$ ; 6" and above  $\pm 0.06$

J Intersections of centerlines to bottom of socket; 45° & 30° Ells : up to 4"  $\pm 0.03$ ; 6" and above  $\pm 0.06$

L Overall Length of fitting :  $\pm 0.06$

N Socket Bottom to Socket Bottom; Couplings, Unions :  $\pm 0.06$

N1 Socket Bottom to Face of Flange :  $\pm 0.06$

R Thickness on Plugs, Flanges :  $\pm 0.03$

T, T1 Effective Thread Length : Reference Only

W Height of Cap :  $\pm 0.06$

# Schedule 40 CPVC Pressure Pipe

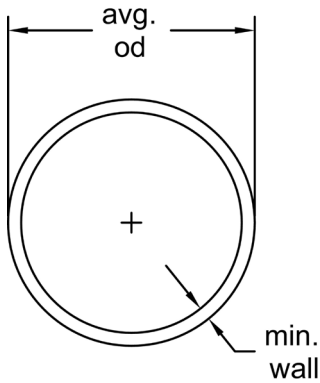
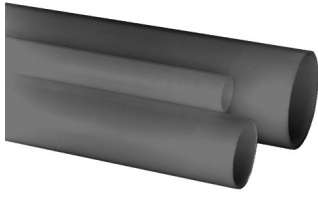

## Harvel Plain End Pipe - 20 Ft Lengths

- Max Water Pressure at 73°F (22.7°C) with solvent-cemented joints

Size (inch)	P/L	Plain End Part No.	Lift Qty. (20ft Lgths) (ft)	Average O.D. (inch)	min. wall (inch)	Wt/Ft (lbs/ft)	Max Water Pressure (psi)
¼	H23	H0400025CG2000	5700	0.540	0.088	0.091	780
⅜	H23	H0400038CG2000	5700	0.675	0.091	0.122	620
½	H23	H0400050CG2000	5700	0.840	0.109	0.180	600
¾	H23	H0400075CG2000	5260	1.050	0.113	0.239	480
1	H23	H0400100CG2000	4280	1.315	0.133	0.352	450
1 ¼	H23	H0400125CG2000	2360	1.660	0.140	0.475	370
1 ½	H23	H0400150CG2000	2060	1.900	0.145	0.568	330
2	H23	H0400200CG2000	1660	2.375	0.154	0.761	280
2 ½	H23	H0400250CG2000	1080	2.875	0.203	1.201	300
3	H23	H0400300CG2000	840	3.500	0.216	1.572	260
3 ½	H23	H0400350CG2000	680	4.000	0.226	1.905	240
4	H23	H0400400CG2000	520	4.500	0.237	2.239	220
5	H23	H0400500CG2000	400	5.563	0.258	3.095	190
6	H23	H0400600CG2000	340	6.625	0.280	3.945	180
8	H23	H0400800CG2000	220	8.625	0.322	5.958	160
10	H23	H0401000CG2000	80	10.750	0.365	8.458	140
12	H23	H0401200CG2000	60	12.750	0.406	11.172	130
14	H23	H0401400CG2000	60	14.000	0.437	13.262	130
16	H23	H0401600CG2000	60	16.000	0.500	17.312	130
18	H23	H0401800CG2000	40	18.000	0.562	0.586	130
20	H23	H0402000CG2000	40	20.000	0.593	26.530	120
24	H23	H0402400CG2000	40	24.000	0.687	36.916	120

## Harvel Belled End Pipe - 20 Ft Length Less Bell

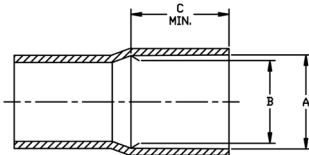

Size (inch)	P/L	Belled End Part No.	A-Socket Entrance (Belled Pipe)	B-Socket Bottom (Belled Pipe)	C-Min. (Belled Pipe)
½	H23	H0400050CG200B	0.848±0.004	0.836±0.004	1.000
¾	H23	H0400075CG200B	1.058±0.004	1.046±0.004	1.250
1	H23	H0400100CG200B	1.325±0.005	1.310±0.005	1.500
1 ¼	H23	H0400125CG200B	1.670±0.005	1.655±0.005	1.750
1 ½	H23	H0400150CG200B	1.912±0.005	1.894±0.006	2.000
2	H23	H0400200CG200B	2.387±0.006	2.363±0.006	2.250
2 ½	H23	H0400250CG200B	2.889±0.007	2.861±0.007	2.500
3	H23	H0400300CG200B	3.516±0.008	3.484±0.008	3.250
3 ½	H23	H0400350CG200B	4.016±0.008	3.984±0.008	3.500
4	H23	H0400400CG200B	4.518±0.009	4.482±0.009	4.000
5	H23	H0400500CG200B	5.583±0.010	5.543±0.010	4.000
6	H23	H0400600CG200B	6.647±0.011	6.603±0.011	6.000
8	H23	H0400800CG200B	8.655±0.015	8.598±0.015	6.000
10	H23	H0401000CG200B	10.776±0.015	10.722±0.015	7.500
12	H23	H0401200CG200B	12.778±0.015	12.721±0.015	8.500
14	H23	H0401400CG200B	14.035±0.015	13.985±0.015	9.000
16	H23	H0401600CG200B	16.045±0.015	15.980±0.015	10.000
18	H23	H0401800CG200B	18.055±0.020	17.980±0.020	12.000
20	H23	H0402000CG200B	20.065±0.025	19.980±0.025	12.000
24	H23	H0402400CG200B	24.075±0.030	23.970±0.030	12.000

# ChlorFIT® Schedule 80 CPVC Pressure Pipe

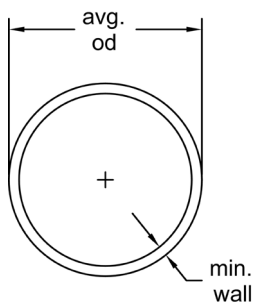

## Schedule 80 CORZAN® CPVC Plain End Pipe - 20 Ft Lengths

- Max Water Pressure at 73°F (22.7°C) with solvent-cemented joints

Size (inch)	P/L	Plain End Part No.	Lift Qty (ft)	Average O.D. (inch)	min. wall (inch)	Wt/Ft (lbs/ft)	Max Water Pressure (psi)
¼	H06	H0800025CG2000	5700	0.540	0.119	0.112	1130
¾	H06	H0800038CG2000	5700	0.675	0.126	0.154	920
½	H06	H0800050CG2000	5700	0.840	0.147	0.225	850
¾	H06	H0800075CG2000	5260	1.050	0.154	0.305	690
1	H06	H0800100CG2000	4280	1.315	0.179	0.449	630
1 ¼	H06	H0800125CG2000	2360	1.660	0.191	0.618	520
1 ½	H06	H0800150CG2000	2060	1.900	0.200	0.751	470
2	H06	H0800200CG2000	1660	2.375	0.218	1.040	400
2 ½	H06	H0800250CG2000	1080	2.875	0.276	1.584	420
3	H06	H0800300CG2000	840	3.500	0.300	2.124	370
3 ½	H06	H0800350CG2000	680	4.000	0.318	2.607	350
4	H06	H0800400CG2000	520	4.500	0.337	3.105	320
5	H06	H0800500CG2000	400	5.563	0.375	4.343	290
6	H06	H0800600CG2000	340	6.625	0.432	5.929	280
8	H06	H0800800CG2000	220	8.625	0.500	9.051	250
10	H06	H0801000CG2000	80	10.750	0.593	13.429	230
12	H06	H0801200CG2000	60	12.750	0.687	18.458	230
14	H06	H0801400CG2000	60	14.000	0.750	22.224	220
16	H06	H0801600CG2000	60	16.000	0.843	28.557	220
18	H06	H0801800CG2000	40	18.000	0.937	35.745	220
20	H06	H0802000CG2000	40	20.000	1.031	45.022	220
24	H06	H0802400CG2000	40	24.000	1.218	63.878	210

## Schedule 80 CORZAN® CPVC Belled End Pipe - 20 Ft. Length Less Bell

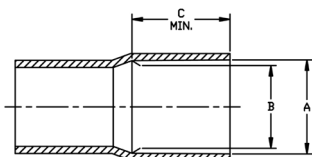

Size (inch)	P/L	Belled End Part No.	A-Socket Entrance (Belled Pipe)	B-Socket Bottom (Belled Pipe)	C-Min. (Belled Pipe)
½	H06	H0800050CG200B	0.848±0.004	0.836±0.004	1.000
¾	H06	H0800075CG200B	1.058±0.004	1.046±0.004	1.250
1	H06	H0800100CG200B	1.325±0.005	1.310±0.005	1.500
1 ¼	H06	H0800125CG200B	1.670±0.005	1.655±0.005	1.750
1 ½	H06	H0800150CG200B	1.912±0.006	1.894±0.006	2.000
2	H06	H0800200CG200B	2.387±0.006	2.363±0.006	2.250
2 ½	H06	H0800250CG200B	2.889±0.007	2.861±0.007	2.500
3	H06	H0800300CG200B	3.516±0.008	3.484±0.008	3.250
3 ½	H06	H0800350CG200B	4.016±0.008	3.984±0.008	3.500
4	H06	H0800400CG200B	4.518±0.009	4.482±0.009	4.000
5	H06	H0800500CG200B	5.583±0.010	5.543±0.010	4.000
6	H06	H0800600CG200B	6.647±0.011	6.603±0.011	6.000
8	H06	H0800800CG200B	8.655±0.015	8.598±0.015	6.000
10	H06	H0801000CG200B	10.776±0.015	10.722±0.015	7.500
12	H06	H0801200CG200B	12.778±0.015	12.721±0.015	8.500
14	H06	H0801400CG200B	14.035±0.015	13.985±0.015	9.000
16	H06	H0801600CG200B	16.045±0.015	15.980±0.015	10.000
18	H06	H0801800CG200B	18.055±0.020	17.980±0.020	12.000
20	H06	H0802000CG200B	20.065±0.025	19.980±0.025	12.000
24	H06	H0802400CG200B	24.075±0.030	23.970±0.030	12.000



# ChlorFIT® Schedule 80 CPVC Pressure Fittings

## Tee (S x S x S) Schedule 80 CORZAN® CPVC

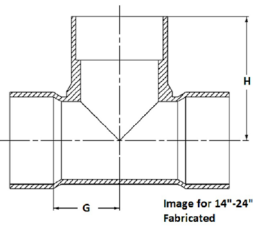
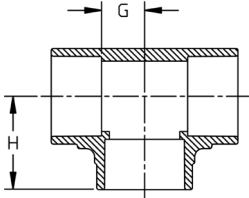
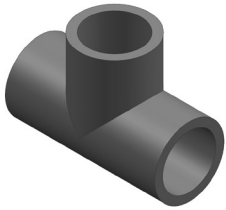

Size (inch)	P/L	Part No.	Pack Qty	H (inch)	G (inch)	Design
½	625	9801-005	25	1.41	0.51	SL
¾	625	9801-007	15	1.60	0.58	SL
1	625	9801-010	20	1.85	0.71	SL
1 ¼	625	9801-012	5	2.17	0.91	SL
1 ½	625	9801-015	5	2.43	1.04	SL
2	625	9801-020	5	2.81	1.30	SL
2 ½	625	9801-025	5	3.31	1.55	SL
3	625	9801-030	5	3.71	1.81	SL
4	625	9801-040	5	4.60	2.33	SL
6	625	9801-060	2	6.53	3.51	SL
8	625	9801-080	1	8.66	4.58	SL
10	B10	9801-100	1	10.79	5.78	SL
12	B10	9801-120	1	12.96	6.94	SL
14	A34	9801-140N	1	19.50	10.88	FAB
16	A34	9801-160N	1	22.75	12.13	FAB
18	A34	9801-180N	1	26.00	13.38	FAB
20	A34	9801-200N	1	28.25	14.63	FAB
24	A34	9801-240N	1	34.50	17.13	FAB

## Reducing Tee (S x S x S) Schedule 80 CORZAN® CPVC

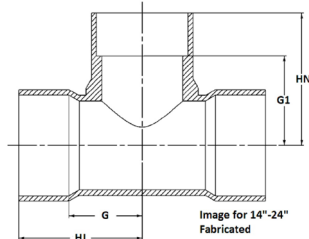
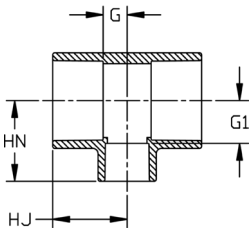
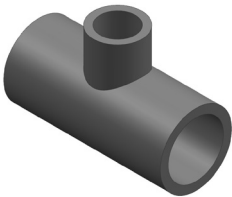

Size (inch)	P/L	Part No.	Pack Qty	HJ (inch)	HN (inch)	G (inch)	G1 (inch)	Design
¾ x ½	625	9801-101	25	1.62	1.62	0.60	0.72	SL
1 x ½	625	9801-130	25	1.87	1.64	0.72	0.74	SL
1 x ¾	625	9801-131	25	1.86	1.89	0.72	0.75	SL
1 ¼ x ½	625	9801-166FB	20	1.99	2.35	0.73	1.47	BUSH
1 ¼ x ¾	625	9801-167FB	20	1.99	2.35	0.73	1.33	BUSH
1 ¼ x 1	625	9801-168	20	2.01	2.05	0.73	0.91	SL
1 ½ x ½	625	9801-209	5	1.92	1.91	0.53	1.03	SL
1 ½ x ¾	625	9801-210	5	1.99	2.07	0.60	1.05	SL
1 ½ x 1	625	9801-211	5	2.12	2.17	0.72	1.03	SL
1 ½ x 1 ¼	625	9801-212FB	5	2.44	2.74	1.04	1.47	BUSH
2 x ½	625	9801-247	5	1.99	2.16	0.54	1.28	SL
2 x ¾	625	9801-248	5	2.22	2.31	0.60	1.30	SL
2 x 1	625	9801-249	5	2.24	2.42	0.72	1.27	SL
2 x 1 ¼	625	9801-250FB	5	2.81	3.11	1.30	1.84	BUSH
2 x 1 ½	625	9801-251	5	2.54	2.66	1.03	1.27	SL
2 ½ x ½	625	9801-287FB	5	3.05	3.35	1.28	2.44	BUSH
2 ½ x ¾	625	9801-288FB	5	3.05	3.35	1.28	2.33	BUSH
2 ½ x 1	625	9801-289FB	5	3.05	3.36	1.28	2.22	BUSH
2 ½ x 1 ¼	625	9801-290FB	5	3.05	3.34	1.28	2.07	BUSH
2 ½ x 1 ½	625	9801-291FB	5	3.05	3.35	1.28	1.94	BUSH
2 ½ x 2	625	9801-292	5	3.05	3.05	1.28	1.54	SL
3 x ½	625	9801-333FB	5	3.20	3.68	1.30	2.77	BUSH
3 x ¾	625	9801-334FB	5	3.20	3.68	1.30	2.66	BUSH
3 x 1	625	9801-335FB	5	3.20	3.69	1.30	2.55	BUSH
3 x 1 ¼	625	9801-336FB	5	3.20	3.67	1.30	2.40	BUSH
3 x 1 ½	625	9801-337FB	5	3.20	3.68	1.30	2.27	BUSH
3 x 2	625	9801-338	5	3.20	3.39	1.30	1.87	SL
3 x 2 ½	625	9801-339FB	5	3.73	4.07	1.81	2.17	BUSH
4 x ½	625	9801-415FB	5	3.52	4.19	1.27	3.28	BUSH
4 x ¾	625	9801-416FB	5	3.52	4.19	1.27	3.17	BUSH

table continued on the next page

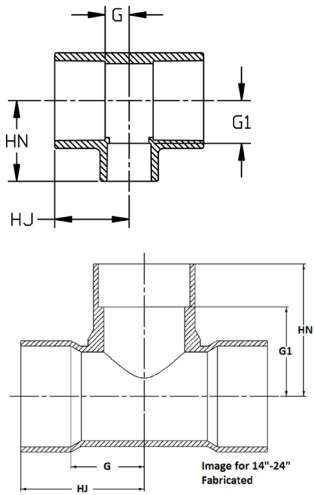

Size (inch)	P/L	Part No.	Pack Qty	HJ (inch)	HN (inch)	G (inch)	G1 (inch)	Design
4 x 1	625	9801-417FB	5	3.53	4.12	1.26	3.00	BUSH
4 x 1 ¼	625	9801-418FB	5	3.52	4.18	1.27	2.91	BUSH
4 x 1 ½	625	9801-419FB	5	3.52	4.19	1.27	2.78	BUSH
4 x 2	625	9801-420	5	3.54	3.87	1.27	2.37	SL
4 x 2 ½	625	9801-421FB	5	4.14	4.62	1.85	2.73	BUSH
4 x 3	625	9801-422	5	4.13	4.26	1.85	2.35	SL
6 x ½	625	9801-523FB	1	6.56	7.42	3.56	6.52	BUSH
6 x ¾	625	9801-524FB	1	6.56	7.43	3.49	6.41	BUSH
6 x 1	625	9801-525FB	2	6.56	7.44	3.49	6.29	BUSH
6 x 1 ¼	625	9801-526FB	2	6.56	7.42	3.49	6.15	BUSH
6 x 1 ½	625	9801-527FB	1	6.56	7.42	3.49	6.02	BUSH
6 x 2	625	9801-528	2	4.45	5.25	1.43	3.74	SL
6 x 2 ½	625	9801-529FB	2	6.56	7.52	3.49	5.62	BUSH
6 x 3	625	9801-530FB	2	6.56	7.21	3.49	5.25	BUSH
6 x 4	625	9801-532	2	6.57	6.80	3.49	4.47	HS
8 x 4	625	9801-582FB	1	7.63	8.09	3.59	5.84	BUSH
8 x 5	625	9801-583FB	1	7.58	8.01	3.49	5.37	FAB
8 x 6	625	9801-585	1	7.65	7.54	3.55	4.63	SL
10 x 2	A34	9801-619N	1	10.75	11.50	5.75	9.50	FAB
10 x 3	A34	9801-621N	1	10.75	11.50	5.75	9.50	FAB
10 x 4	A34	9801-623N	1	10.75	11.50	5.75	9.50	FAB
10 x 6	B10	9801-626FB	1	10.83	11.43	5.78	8.33	BUSH
10 x 6	A34	9801-626N	1	11.88	12.50	6.88	9.50	FAB
10 x 8	B10	9801-628FB	1	10.83	11.46	5.78	7.36	BUSH
10 x 8	A34	9801-628N	1	13.00	13.50	8.00	9.50	FAB
12 x 2	A34	9801-659N	1	12.00	12.75	6.00	10.75	FAB
12 x 3	A34	9801-661N	1	12.00	12.75	6.00	10.75	FAB
12 x 4	A34	9801-663N	1	12.00	12.75	6.00	10.75	FAB
12 x 6	A34	9801-666N	1	13.13	13.75	7.13	10.75	FAB
12 x 8	B10	9801-668FB	1	12.99	13.67	6.94	9.58	BUSH
12 x 8	A34	9801-668N	1	14.13	14.75	8.13	10.75	FAB
12 x 10	B10	9801-670FB	1	12.99	13.68	6.94	8.57	BUSH
12 x 10	A34	9801-670N	1	15.13	15.75	9.13	10.75	FAB
14 x 2	A34	9801-692N	1	13.13	13.50	6.13	11.50	FAB
14 x 3	A34	9801-694N	1	13.13	13.50	6.13	11.50	FAB
14 x 4	A34	9801-696N	1	13.13	13.50	6.13	11.50	FAB
14 x 6	A34	9801-698N	1	14.25	14.50	7.25	11.50	FAB
14 x 8	A34	9801-700N	1	15.25	15.50	8.25	11.50	FAB
14 x 10	A34	9801-702N	1	16.25	16.50	9.25	11.50	FAB
14 x 12	A34	9801-704N	1	17.25	18.50	10.25	12.50	FAB
16 x 2	A34	9801-726N	1	14.38	14.75	6.38	12.75	FAB
16 x 3	A34	9801-728N	1	14.38	14.75	6.38	12.75	FAB
16 x 4	A34	9801-730N	1	14.38	14.75	6.38	12.75	FAB
16 x 6	A34	9801-732N	1	15.50	15.75	7.50	12.75	FAB
16 x 8	A34	9801-734N	1	16.50	16.75	8.50	12.75	FAB
16 x 10	A34	9801-736N	1	17.50	17.75	9.50	12.75	FAB
16 x 12	A34	9801-738N	1	18.50	19.75	10.50	13.75	FAB
16 x 14	A34	9801-740N	1	19.13	20.75	11.13	13.75	FAB
18 x 4	A34	9801-784N	1	15.63	16.00	6.63	14.00	FAB
18 x 6	A34	9801-786N	1	16.75	17.00	7.75	14.00	FAB
18 x 8	A34	9801-788N	1	17.75	18.00	8.75	14.00	FAB
18 x 10	A34	9801-790N	1	18.75	19.00	9.75	14.00	FAB
18 x 12	A34	9801-792N	1	19.75	21.00	10.75	15.00	FAB
18 x 14	A34	9801-794N	1	20.38	22.00	11.38	15.00	FAB
18 x 16	A34	9801-796N	1	21.38	24.00	12.38	16.00	FAB
20 x 4	A34	9801-814N	1	16.88	17.25	6.88	15.25	FAB
20 x 6	A34	9801-816N	1	18.00	18.25	8.00	15.25	FAB
20 x 8	A34	9801-818N	1	19.00	19.25	9.00	15.25	FAB
20 x 10	A34	9801-820N	1	20.00	20.25	10.00	15.25	FAB
20 x 12	A34	9801-822N	1	21.00	22.25	11.00	16.25	FAB
20 x 14	A34	9801-824N	1	21.63	23.25	11.63	16.25	FAB
20 x 16	A34	9801-826N	1	22.63	25.25	12.63	17.25	FAB
20 x 18	A34	9801-828N	1	23.63	27.25	13.63	18.25	FAB

table continued on the next page

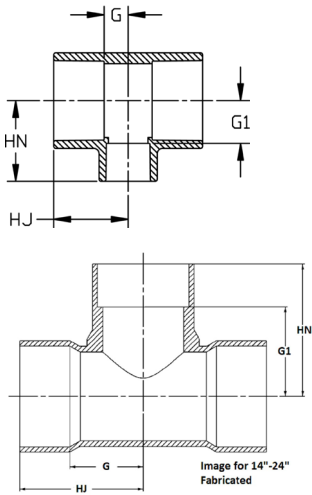

Size (inch)	P/L	Part No.	Pack Qty	HJ (inch)	HN (inch)	G (inch)	G1 (inch)	Design
24 x 4	A34	<b>9801-904N</b>	1	19.38	19.50	7.38	17.50	FAB
24 x 6	A34	<b>9801-906N</b>	1	20.50	20.50	8.50	17.50	FAB
24 x 8	A34	<b>9801-908N</b>	1	21.50	21.50	9.50	17.50	FAB
24 x 10	A34	<b>9801-910N</b>	1	22.50	22.50	10.50	17.50	FAB
24 x 12	A34	<b>9801-912N</b>	1	23.50	24.50	11.50	18.50	FAB
24 x 14	A34	<b>9801-914N</b>	1	24.13	25.50	12.13	18.50	FAB
24 x 16	A34	<b>9801-916N</b>	1	25.13	27.50	13.13	19.50	FAB
24 x 18	A34	<b>9801-918N</b>	1	26.13	30.50	14.13	20.50	FAB
24 x 20	A34	<b>9801-920N</b>	1	27.13	32.50	15.13	20.50	FAB

### Tee (FPT x FPT x FPT) Schedule 80 CORZAN® CPVC

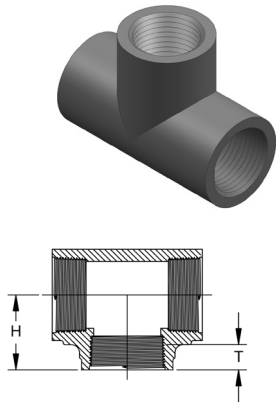

Size (inch)	P/L	Part No.	Pack Qty	H (inch)	T (inch)	Design
¼	625	<b>9805-002</b>	50	0.94	0.59	HS
⅜	625	<b>9805-003</b>	50	1.01	0.60	HS
½	625	<b>9805-005</b>	25	1.26	0.76	HS
¾	625	<b>9805-007</b>	15	1.36	0.72	HS
1	625	<b>9805-010</b>	15	1.79	0.99	HS
1 ¼	625	<b>9805-012</b>	10	1.93	1.01	HS
1 ½	625	<b>9805-015</b>	10	2.08	1.03	HS
2	625	<b>9805-020</b>	5	2.39	1.06	HS
2 ½	625	<b>9805-025</b>	5	2.87	1.35	HS
3	625	<b>9805-030</b>	5	3.52	1.65	HS
4	625	<b>9805-040</b>	5	4.07	1.72	HS

### 90° Ell (S x S) Schedule 80 CORZAN® CPVC

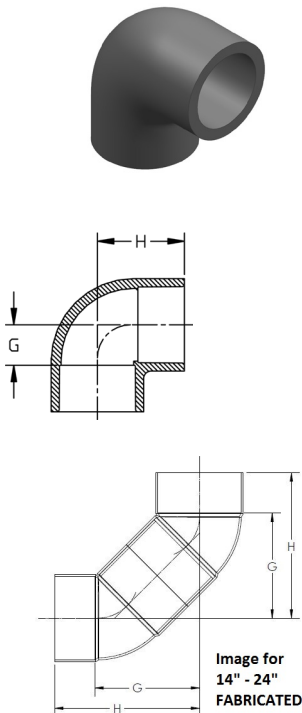

Size (inch)	P/L	Part No.	Pack Qty	H (inch)	G (inch)	Design
¼	625	<b>9806-002</b>	50	0.96	0.35	HS
½	625	<b>9806-005</b>	25	1.41	0.51	SL
¾	625	<b>9806-007</b>	25	1.60	0.57	SL
1	625	<b>9806-010</b>	10	1.83	0.68	SL
1 ¼	625	<b>9806-012</b>	10	2.18	0.90	SL
1 ½	625	<b>9806-015</b>	10	2.43	1.04	SL
2	625	<b>9806-020</b>	20	2.80	1.27	SL
2 ½	625	<b>9806-025</b>	5	3.33	1.53	SL
3	625	<b>9806-030</b>	5	3.73	1.81	SL
4	625	<b>9806-040</b>	5	4.63	2.32	SL
6	625	<b>9806-060</b>	2	6.56	3.53	SL
8	625	<b>9806-080</b>	1	8.68	4.55	SL
10	B10	<b>9806-100</b>	1	10.79	5.77	SL
12	B10	<b>9806-120</b>	1	12.92	6.87	SL
14	A34	<b>9806-140N</b>	1	26.00	19.00	FAB
16	A34	<b>9806-160N</b>	1	29.00	21.00	FAB
18	A34	<b>9806-180N</b>	1	33.50	24.50	FAB
20	A34	<b>9806-200N</b>	1	35.75	25.75	FAB
24	A34	<b>9806-240N</b>	1	43.00	31.00	FAB

90° ELL (S x FPT) Schedule 80 CORZAN® CPVC

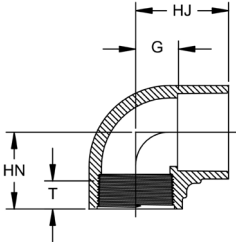
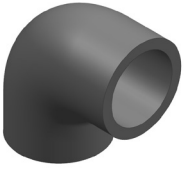

Size (inch)	P/L	Part No.	Pack Qty	HJ (inch)	HN (inch)	G (inch)	T (inch)	Design
½	625	<b>9807-005</b>	25	1.40	1.31	0.50	0.81	HS
¾	625	<b>9807-007</b>	25	1.59	1.36	0.58	0.72	HS
1	625	<b>9807-010</b>	10	1.81	1.70	0.67	1.00	HS
1 ¼	625	<b>9807-012</b>	10	2.15	1.92	0.89	1.03	HS
1 ½	625	<b>9807-015</b>	10	2.39	2.05	1.01	1.05	HS
2	625	<b>9807-020</b>	5	2.77	2.36	1.24	1.09	HS
3	625	<b>9807-030</b>	5	3.73	3.47	1.83	1.66	HS

90° ELL (FPT x FPT) Schedule 80 CORZAN® CPVC

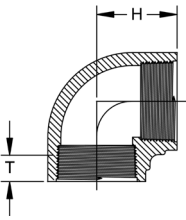
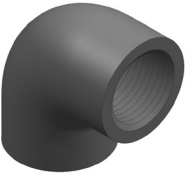

Size (inch)	P/L	Part No.	Pack Qty	H (inch)	T (inch)	Design
¼	625	<b>9808-002</b>	50	0.94	0.61	HS
¾	625	<b>9808-003</b>	50	1.00	0.63	HS
½	625	<b>9808-005</b>	25	1.27	0.78	HS
¾	625	<b>9808-007</b>	20	1.36	0.72	HS
1	625	<b>9808-010</b>	10	1.71	1.00	HS
1 ¼	625	<b>9808-012</b>	10	1.92	1.01	HS
1 ½	625	<b>9808-015</b>	10	2.08	1.06	HS
2	625	<b>9808-020</b>	5	2.36	1.08	HS
2 ½	625	<b>9808-025</b>	5	3.36	1.51	HS
3	625	<b>9808-030</b>	5	3.53	1.63	HS
4	625	<b>9808-040</b>	5	4.17	1.75	HS

**45° Ell (S x S) Schedule 80 CORZAN® CPVC**

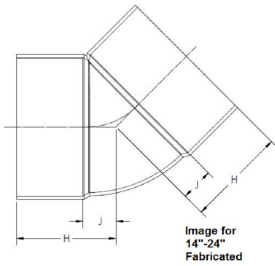
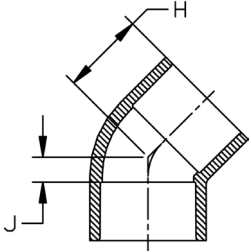
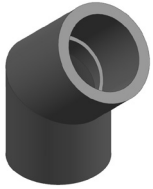

Size (inch)	P/L	Part No.	Pack Qty	H (inch)	J (inch)	Design
½	625	<b>9817-005</b>	25	1.22	0.30	SL
¾	625	<b>9817-007</b>	20	1.29	0.28	SL
1	625	<b>9817-010</b>	25	1.48	0.32	SL
1 ¼	625	<b>9817-012</b>	15	1.78	0.47	SL
1 ½	625	<b>9817-015</b>	10	1.88	0.45	SL
2	625	<b>9817-020</b>	5	2.16	0.60	SL
2 ½	625	<b>9817-025</b>	5	2.56	0.79	SL
3	625	<b>9817-030</b>	5	2.67	0.77	SL
4	625	<b>9817-040</b>	5	3.31	1.04	SL
6	625	<b>9817-060</b>	2	4.86	1.77	SL
8	625	<b>9817-080</b>	2	6.15	2.07	SL
10	B10	<b>9817-100</b>	1	7.51	2.46	SL
12	B10	<b>9817-120</b>	1	9.00	2.96	SL
14	A34	<b>9817-140N</b>	1	10.25	3.50	FAB
16	A34	<b>9817-160N</b>	1	11.75	3.75	FAB
18	A34	<b>9817-180N</b>	1	13.25	4.25	FAB
20	A34	<b>9817-200N</b>	1	14.75	4.75	FAB
24	A34	<b>9817-240N</b>	1	17.75	5.75	FAB

**45° Ell (FPT x FPT) Schedule 80 CORZAN® CPVC**

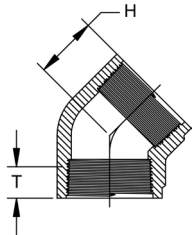
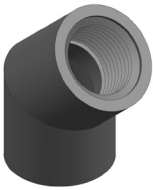

Size (inch)	P/L	Part No.	Pack Qty	H (inch)	T (inch)	Design
¼	625	<b>9819-002</b>	50	0.69	0.59	HS
½	625	<b>9819-005</b>	25	1.02	0.76	SL
¾	625	<b>9819-007</b>	20	1.14	0.81	SL
1	625	<b>9819-010</b>	25	1.33	0.97	SL
1 ¼	625	<b>9819-012</b>	15	1.42	1.01	SL
1 ½	625	<b>9819-015</b>	10	1.47	1.07	SL
2	625	<b>9819-020</b>	5	1.74	2.37	SL
3	625	<b>9819-030</b>	5	2.43	1.66	SL
4	625	<b>9819-040</b>	5	2.78	1.76	SL

**Coupling (S x S) Schedule 80 CORZAN® CPVC**

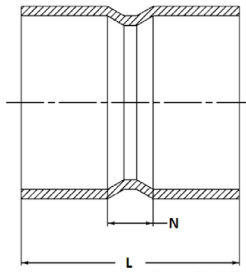
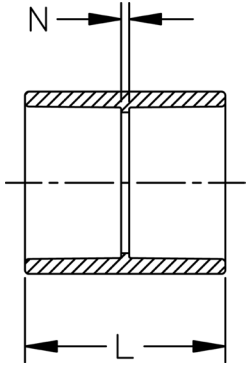
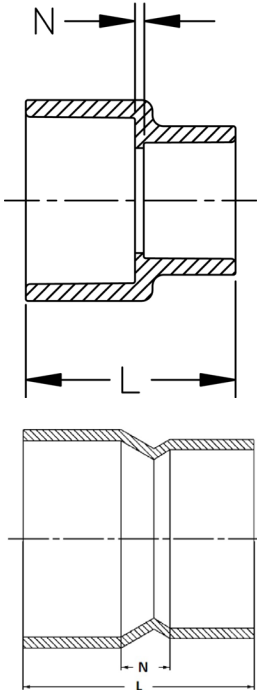

Image for 14"-24"  
Fabricated

Size (inch)	P/L	Part No.	Pack Qty	L (inch)	N (inch)	Design
½	625	<b>9829-005</b>	25	1.93	0.12	SL
¾	625	<b>9829-007</b>	20	2.18	0.12	SL
1	625	<b>9829-010</b>	25	2.41	0.12	SL
1 ¼	625	<b>9829-012</b>	25	2.67	0.13	SL
1 ½	625	<b>9829-015</b>	10	2.94	0.15	SL
2	625	<b>9829-020</b>	5	3.18	0.13	SL
2 ½	625	<b>9829-025</b>	5	3.77	0.19	SL
3	625	<b>9829-030</b>	5	4.04	0.26	SL
4	625	<b>9829-040</b>	5	4.80	0.26	SL
6	625	<b>9829-060</b>	2	6.40	0.36	SL
8	625	<b>9829-080</b>	2	8.40	0.35	SL
10	B10	<b>9829-100</b>	1	10.77	0.75	SL
12	B10	<b>9829-120</b>	1	12.82	0.75	SL
14	A34	<b>9829-140N</b>	1	17.75	3.75	FAB
16	A34	<b>9829-160N</b>	1	20.25	4.25	FAB
18	A34	<b>9829-180N</b>	1	22.75	4.75	FAB
20	A34	<b>9829-200N</b>	1	25.25	5.25	FAB
24	A34	<b>9829-240N</b>	1	30.25	6.25	FAB



Reducing Coupling (S x S) Schedule 80 CORZAN® CPVC



Images for 14"-24"  
Fabricated

Size (inch)	P/L	Part No.	Pack Qty	L (inch)	N (inch)	Design
¾ x ½	625	9829-101	25	2.13	0.13	HS
1 x ½	625	9829-130	25	2.17	0.12	HS
1 x ¾	625	9829-131	25	2.26	0.11	HS
1 ¼ x ¾	625	9829-167FB	15	2.94	0.66	BUSH
1 ¼ x 1	625	9829-168FB	15	2.52	0.10	BUSH
1 ½ x ½	625	9829-209FB	15	2.94	0.64	BUSH
1 ½ x ¾	625	9829-210FB	15	2.50	0.54	BUSH
1 ½ x 1	625	9829-211	15	2.65	0.11	HS
1 ½ x 1 ¼	625	9829-212	20	2.82	0.09	HS
2 x ½	625	9829-247FB	5	3.44	0.87	BUSH
2 x ¾	625	9829-248FB	5	3.39	0.77	BUSH
2 x 1	625	9829-249	5	3.15	0.32	HS
2 x 1 ¼	625	9829-250	5	3.05	0.14	HS
2 x 1 ½	625	9829-251	5	3.06	0.07	HS
2 ½ x 1 ½	625	9829-291	5	3.36	0.14	HS
2 ½ x 2	625	9829-292FB	5	4.08	0.66	BUSH
3 x 1	625	9829-335FB	5	4.56	1.53	BUSH
3 x 1 ½	625	9829-337FB	5	4.58	1.15	BUSH
3 x 2	625	9829-338	5	3.61	0.17	HS
3 x 2 ½	625	9829-339FB	5	4.42	0.63	BUSH
4 x 2	625	9829-420FB	5	4.94	1.08	BUSH
4 x 2 ½	625	9829-421FB	5	4.92	0.65	BUSH
4 x 3	625	9829-422	5	4.38	0.22	HS
6 x 4	625	9829-532	2	10.17	3.46	HS
8 x 4	625	9829-582FB	2	9.81	3.53	BUSH
8 x 6	625	9829-585	2	9.18	2.11	HS
10 x 4	A34	9829-623N	1	17.00	10.00	FAB
10 x 6	B10	9829-626FB	1	11.42	3.29	BUSH
10 x 6	A34	9829-626N	1	13.00	5.00	FAB
10 x 8	B10	9829-628FB	1	11.45	2.32	BUSH
10 x 8	A34	9829-628N	1	12.75	3.75	FAB
12 x 4	A34	9829-663N	1	26.25	18.25	FAB
12 x 6	A34	9829-666N	1	20.50	11.50	FAB
12 x 8	B10	9829-668FB	1	13.54	3.41	BUSH
12 x 8	A34	9829-668N	1	15.50	5.50	FAB
12 x 10	B10	9829-670FB	1	13.24	2.13	BUSH
12 x 10	A34	9829-670N	1	15.00	4.00	FAB
14 x 4	A34	9829-696N	1	13.00	3.00	FAB
14 x 6	A34	9829-698N	1	31.00	21.00	FAB
14 x 8	A34	9829-700N	1	21.00	10.00	FAB
14 x 10	A34	9829-702N	1	17.00	5.00	FAB
14 x 12	A34	9829-704N	1	16.50	3.50	FAB
16 x 4	A34	9829-730N	1	16.50	3.50	FAB
16 x 6	A34	9829-732N	1	16.50	4.50	FAB
16 x 8	A34	9829-734N	1	18.05	5.00	FAB
16 x 10	A34	9829-736N	1	19.00	5.10	FAB
16 x 12	A34	9829-738N	1	19.25	5.25	FAB
16 x 14	A34	9829-740N	1	19.50	4.50	FAB
18 x 4	A34	9829-784N	1	48.50	37.50	FAB
18 x 6	A34	9829-786N	1	36.00	24.00	FAB
18 x 8	A34	9829-788N	1	42.50	29.50	FAB
18 x 10	A34	9829-790N	1	33.50	19.50	FAB
18 x 12	A34	9829-792N	1	22.00	7.00	FAB
18 x 14	A34	9829-794N	1	22.25	6.25	FAB
18 x 16	A34	9829-796N	1	21.75	4.75	FAB
20 x 4	A34	9829-814N	1	60.50	48.50	FAB
20 x 6	A34	9829-816N	1	55.50	42.50	FAB
20 x 8	A34	9829-818N	1	56.25	42.25	FAB
20 x 10	A34	9829-820N	1	47.25	32.25	FAB
20 x 12	A34	9829-822N	1	37.00	21.00	FAB
20 x 14	A34	9829-824N	1	37.25	20.25	FAB

table continued on the next page

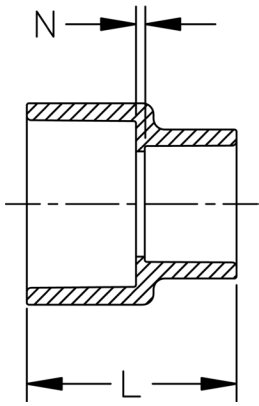

Size (inch)	P/L	Part No.	Pack Qty	L (inch)	N (inch)	Design
20 x 16	A34	<b>9829-826N</b>	1	24.50	6.50	FAB
20 x 18	A34	<b>9829-828N</b>	1	24.00	5.00	FAB
24 x 4	A34	<b>9829-904N</b>	1	66.00	52.00	FAB
24 x 6	A34	<b>9829-906N</b>	1	61.00	46.00	FAB
24 x 8	A34	<b>9829-908N</b>	1	52.00	36.00	FAB
24 x 10	A34	<b>9829-910N</b>	1	52.75	35.75	FAB
24 x 12	A34	<b>9829-912N</b>	1	42.50	24.50	FAB
24 x 14	A34	<b>9829-914N</b>	1	42.75	23.75	FAB
24 x 16	A34	<b>9829-916N</b>	1	42.25	22.25	FAB
24 x 18	A34	<b>9829-918N</b>	1	29.50	8.50	FAB
24 x 20	A34	<b>9829-920N</b>	1	29.25	7.25	FAB

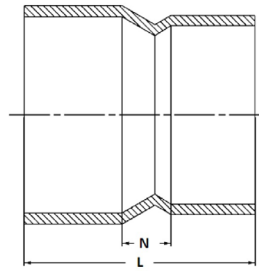
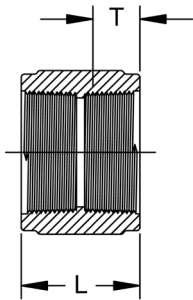
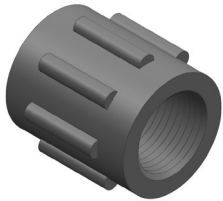

Image for 14"-24"  
Fabricated

#### Coupling (FPT x FPT) Schedule 80 CORZAN® CPVC



Size (inch)	P/L	Part No.	Pack Qty	L (inch)	T (inch)	Design
¼	625	<b>9830-002</b>	50	1.29	0.61	HS
¾	625	<b>9830-003</b>	50	1.35	0.62	HS
½	625	<b>9830-005</b>	25	1.68	0.77	SL
¾	625	<b>9830-007</b>	25	1.75	0.80	SL
1	625	<b>9830-010</b>	25	2.13	0.99	SL
1 ¼	625	<b>9830-012</b>	25	2.19	1.03	SL
1 ½	625	<b>9830-015</b>	10	2.22	1.03	SL
2	625	<b>9830-020</b>	5	2.29	1.08	SL
2 ½	625	<b>9830-025</b>	5	3.33	1.51	SL
3	625	<b>9830-030</b>	5	3.53	1.65	SL
4	625	<b>9830-040</b>	5	3.76	1.75	SL

### Reducing Coupling (FPT x FPT) Schedule 80 CORZAN® CPVC

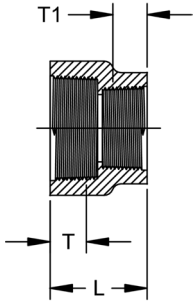

Size (inch)	P/L	Part No.	Pack Qty	L (inch)	T (inch)	T1 (inch)	Design
3/8 x 1/4	625	<b>9830-052</b>	50	1.29	0.60	0.59	HS
1/2 x 1/4	625	<b>9830-072</b>	50	1.45	0.75	0.59	HS
1/2 x 3/8	625	<b>9830-073</b>	50	1.46	0.74	0.60	HS
3/4 x 1/2	625	<b>9830-101</b>	25	1.69	0.78	0.78	HS
1 x 1/2	625	<b>9830-130</b>	25	1.84	0.98	0.77	HS
1 x 3/4	625	<b>9830-131</b>	25	1.88	0.98	0.80	HS
1 1/4 x 3/4	625	<b>9830-167</b>	25	1.90	1.00	0.79	HS
1 1/2 x 1	625	<b>9830-211</b>	20	2.06	1.02	0.95	HS
2 x 1 1/2	625	<b>9830-251</b>	20	2.18	1.05	1.02	HS

### Female Adapter (S x FPT) Schedule 80 CORZAN® CPVC

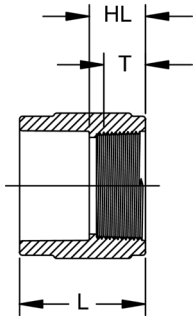

Size (inch)	P/L	Part No.	Pack Qty	HL (inch)	L (inch)	T (inch)	Design
1/4	625	<b>9835-002</b>	50	0.75	1.43	0.58	HS
1/2	625	<b>9835-005</b>	25	0.91	1.80	0.75	HS
3/4	625	<b>9835-007</b>	20	0.95	1.96	0.79	HS
1	625	<b>9835-010</b>	25	1.11	2.27	0.98	HS
1 1/4	625	<b>9835-012</b>	10	1.18	2.44	1.02	HS
1 1/2	625	<b>9835-015</b>	10	1.19	2.59	1.03	HS
2	625	<b>9835-020</b>	5	1.25	2.76	1.06	HS
3	625	<b>9835-030</b>	5	1.91	3.80	1.65	HS
4	625	<b>9835-040</b>	5	2.02	4.29	1.74	HS
6	A34	<b>9835-060N</b>	1	4.50	7.50	1.51	FAB
8	A34	<b>9835-080N</b>	1	4.25	8.50	1.71	FAB
10	A34	<b>9835-100N</b>	1	5.00	10.00	2.00	FAB
12	A34	<b>9835-120N</b>	1	6.00	11.13	2.13	FAB

### Male Adapter (S x MPT) Schedule 80 CORZAN® CPVC

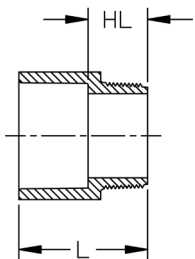

Size (inch)	P/L	Part No.	Pack Qty	HL (inch)	L (inch)	Design
1/2	625	<b>9836-005</b>	50	0.94	1.85	SL
3/4	625	<b>9836-007</b>	25	1.05	2.03	HS
1	625	<b>9836-010</b>	25	1.22	2.38	HS
1 1/4	625	<b>9836-012</b>	15	1.28	2.56	HS
1 1/2	625	<b>9836-015</b>	15	1.30	2.69	HS
2	625	<b>9836-020</b>	5	1.32	2.83	HS
3	625	<b>9836-030</b>	5	1.99	3.90	HS
4	625	<b>9836-040</b>	5	2.15	4.40	HS
6	A34	<b>9836-060N</b>	1	3.25	6.25	FAB
8	A34	<b>9836-080N</b>	1	3.50	7.50	FAB
10	A34	<b>9836-100N</b>	1	4.18	9.18	FAB
12	A34	<b>9836-120N</b>	1	4.63	10.63	FAB

Flush Style Reducer Bushing (SPG x S) Schedule 80 CORZAN® CPVC

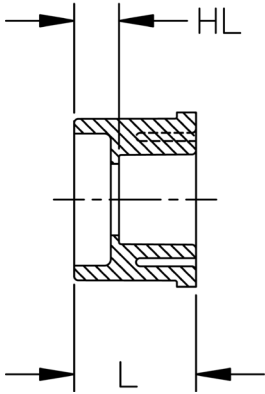
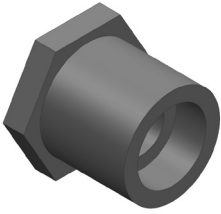

Size (inch)	P/L	Part No.	Pack Qty	HL (inch)	L (inch)	Design
½ x ¼	625	<b>9837-072</b>	50	0.47	1.15	FLUSH
½ x ⅜	625	<b>9837-073</b>	50	0.33	1.09	FLUSH
¾ x ½	625	<b>9837-101</b>	50	0.42	1.30	FLUSH
1 x ½	625	<b>9837-130</b>	50	0.55	1.44	FLUSH
1 x ¾	625	<b>9837-131</b>	50	0.41	1.43	FLUSH
1 ¼ x ½	625	<b>9837-166</b>	25	0.66	1.55	FLUSH
1 ¼ x ¾	625	<b>9837-167</b>	25	0.56	1.57	FLUSH
1 ¼ x 1	625	<b>9837-168</b>	25	0.44	1.59	FLUSH
1 ½ x ½	625	<b>9837-209</b>	25	0.78	1.69	FLUSH
1 ½ x ¾	625	<b>9837-210</b>	25	0.67	1.68	FLUSH
1 ½ x 1	625	<b>9837-211</b>	25	0.55	1.69	FLUSH
1 ½ x 1 ¼	625	<b>9837-212</b>	25	0.44	1.72	FLUSH
2 x ½	625	<b>9837-247</b>	10	0.91	1.81	FLUSH
2 x ¾	625	<b>9837-248</b>	10	0.79	1.82	FLUSH
2 x 1	625	<b>9837-249</b>	10	0.68	1.83	FLUSH
2 x 1 ¼	625	<b>9837-250</b>	10	0.54	1.81	FLUSH
2 x 1 ½	625	<b>9837-251</b>	10	0.40	1.81	FLUSH
2 ½ x 1 ½	625	<b>9837-291</b>	5	0.79	2.31	FLUSH
2 ½ x 2	625	<b>9837-292</b>	5	0.47	2.10	FLUSH
3 x 1	625	<b>9837-335</b>	5	1.27	2.42	FLUSH
3 x 1 ¼	A34	<b>9837-336FB</b>	5	1.43	2.71	FAB
3 x 1 ½	625	<b>9837-337</b>	5	0.89	2.43	FLUSH
3 x 2	625	<b>9837-338</b>	5	0.86	2.42	FLUSH
3 x 2 ½	625	<b>9837-339</b>	5	0.38	2.27	FLUSH
4 x 2	625	<b>9837-420</b>	5	1.14	2.70	FLUSH
4 x 2 ½	625	<b>9837-421FB</b>	5	1.40	2.96	BUSH
4 x 3	625	<b>9837-422</b>	5	0.77	2.74	FLUSH
6 x ¾	625	<b>9837-524FB</b>	2	1.79	4.38	BUSH
6 x 1	625	<b>9837-525FB</b>	2	1.79	4.10	BUSH
6 x 1 ½	625	<b>9837-527FB</b>	2	1.79	4.10	BUSH
6 x 2	625	<b>9837-528FB</b>	2	1.13	4.03	BUSH
6 x 2 ½	625	<b>9837-529FB</b>	2	1.79	3.95	BUSH
6 x 3	625	<b>9837-530</b>	2	1.74	3.65	FLUSH
6 x 4	625	<b>9837-532</b>	2	1.42	3.67	FLUSH
8 x 1 ½	625	<b>9837-577FB</b>	1	1.56	5.66	BUSH
8 x 2	625	<b>9837-578FB</b>	1	1.56	5.59	BUSH
8 x 3	625	<b>9837-580FB</b>	1	1.56	5.15	BUSH
8 x 4	625	<b>9837-582FB</b>	1	1.56	5.15	BUSH
8 x 5	625	<b>9837-583FB</b>	1	2.44	5.09	FAB
8 x 6	625	<b>9837-585</b>	1	1.69	4.66	FLUSH
10 x 2	B10	<b>9837-619FB</b>	1	2.57	6.66	BUSH
10 x 3	B10	<b>9837-621FB</b>	1	2.57	6.15	BUSH
10 x 4	B10	<b>9837-623FB</b>	1	4.01	6.26	BUSH
10 x 6	B10	<b>9837-626</b>	1	2.59	5.69	FLUSH
10 x 8	B10	<b>9837-628</b>	1	1.62	5.72	FLUSH
12 x 3	B10	<b>9837-662FB</b>	1	1.63	7.78	BUSH
12 x 4	B10	<b>9837-663FB</b>	1	1.63	7.78	BUSH
12 x 6	B10	<b>9837-666FB</b>	1	4.26	7.35	BUSH
12 x 8	02	<b>9837-668</b>	1	2.66	6.76	FLUSH
12 x 10	B10	<b>9837-670</b>	1	1.66	6.77	FLUSH
14 x 4	A34	<b>9837-696N</b>	1	5.50	7.50	FAB
14 x 6	A34	<b>9837-698N</b>	1	4.50	7.50	FAB
14 x 8	A34	<b>9837-700N</b>	1	3.50	7.50	FAB
14 x 10	A34	<b>9837-702N</b>	1	2.50	7.50	FAB
14 x 12	A34	<b>9837-704N</b>	1	1.50	7.50	FAB
16 x 4	A34	<b>9837-730N</b>	1	6.50	8.50	FAB
16 x 6	A34	<b>9837-732N</b>	1	5.50	8.50	FAB
16 x 8	A34	<b>9837-734N</b>	1	4.50	8.50	FAB
16 x 10	A34	<b>9837-736N</b>	1	3.50	8.50	FAB
16 x 12	A34	<b>9837-738N</b>	1	2.50	8.50	FAB
16 x 14	A34	<b>9837-740N</b>	1	1.50	8.50	FAB

table continued on the next page

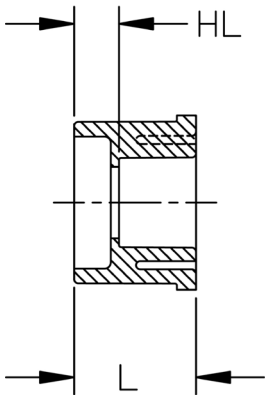

Size (inch)	P/L	Part No.	Pack Qty	HL (inch)	L (inch)	Design
18 x 4	A34	9837-784N	1	7.50	9.50	FAB
18 x 6	A34	9837-786N	1	6.50	9.50	FAB
18 x 8	A34	9837-788N	1	5.50	9.50	FAB
18 x 10	A34	9837-790N	1	4.50	9.50	FAB
18 x 12	A34	9837-792N	1	3.50	9.50	FAB
18 x 14	A34	9837-794N	1	2.50	9.50	FAB
18 x 16	A34	9837-796N	1	1.50	9.50	FAB
20 x 4	A34	9837-814N	1	8.50	10.50	FAB
20 x 6	A34	9837-816N	1	7.50	10.50	FAB
20 x 8	A34	9837-818N	1	6.50	10.50	FAB
20 x 10	A34	9837-820N	1	5.50	10.50	FAB
20 x 12	A34	9837-822N	1	4.50	10.50	FAB
20 x 14	A34	9837-824N	1	3.50	10.50	FAB
20 x 16	A34	9837-826N	1	2.50	10.50	FAB
20 x 18	A34	9837-828N	1	1.50	10.50	FAB
24 x 4	A34	9837-904N	1	10.50	12.50	FAB
24 x 6	A34	9837-906N	1	9.50	12.50	FAB
24 x 8	A34	9837-908N	1	8.50	12.50	FAB
24 x 10	A34	9837-910N	1	7.50	12.50	FAB
24 x 12	A34	9837-912N	1	6.50	12.50	FAB
24 x 14	A34	9837-914N	1	5.50	12.50	FAB
24 x 16	A34	9837-916N	1	4.50	12.50	FAB
24 x 18	A34	9837-918N	1	3.50	12.50	FAB
24 x 20	A34	9837-920N	1	2.50	12.50	FAB

#### Flush Style Reducer Bushing (SPG x FPT) Schedule 80 CORZAN® CPVC

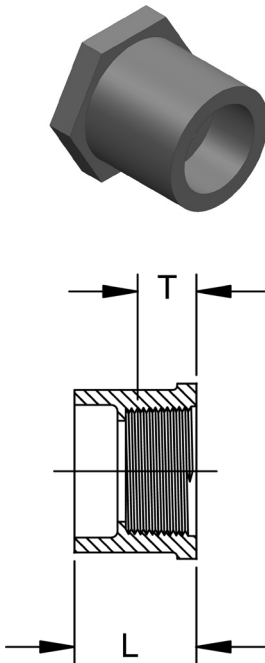

Size (inch)	P/L	Part No.	Pack Qty	L (inch)	T (inch)	Design
½ x ¼	625	9838-072	50	1.14	0.61	FLUSH
½ x ⅜	625	9838-073	50	1.13	0.61	FLUSH
¾ x ¼	625	9838-098	50	1.21	0.60	FLUSH
¾ x ½	625	9838-101	50	1.28	0.77	FLUSH
1 x ½	625	9838-130	50	1.42	0.76	FLUSH
1 x ¾	625	9838-131	50	1.41	0.81	FLUSH
1 ¼ x ½	625	9838-166	15	1.56	0.75	FLUSH
1 ¼ x ¾	625	9838-167	15	1.56	0.79	FLUSH
1 ¼ x 1	625	9838-168	15	1.56	0.99	FLUSH
1 ½ x ½	625	9838-209	15	1.68	0.76	FLUSH
1 ½ x ¾	625	9838-210	15	1.69	0.79	FLUSH
1 ½ x 1	625	9838-211	15	1.68	0.99	FLUSH
1 ½ x 1 ¼	625	9838-212	15	1.69	1.02	FLUSH
2 x ½	625	9838-247	10	1.80	0.77	FLUSH
2 x ¾	625	9838-248	10	1.80	0.80	FLUSH
2 x 1	625	9838-249	10	1.80	0.99	FLUSH
2 x 1 ¼	625	9838-250	10	1.81	1.02	FLUSH
2 x 1 ½	625	9838-251	10	1.88	1.04	FLUSH
2 ½ x 1 ½	625	9838-291	5	2.24	1.07	FLUSH
2 ½ x 2	625	9838-292	5	2.12	1.10	FLUSH
3 x 2	625	9838-338	5	2.42	1.07	FLUSH
4 x 2	625	9838-420	5	2.71	1.10	FLUSH
4 x 3	625	9838-422	5	2.75	1.62	FLUSH

Flush Style Reducer Bushing (MPT x FPT) Schedule 80 CORZAN® CPVC

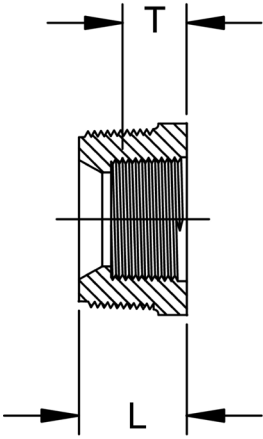
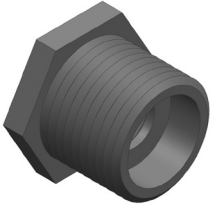

Size (inch)	P/L	Part No.	Pack Qty	L (inch)	T (inch)	Style
3/8 x 1/4	625	<b>9839-052</b>	50	0.80	0.60	FLUSH
1/2 x 1/4	625	<b>9839-072</b>	50	0.95	0.60	FLUSH
1/2 x 3/8	625	<b>9839-073</b>	50	0.96	0.61	FLUSH
3/4 x 3/8	625	<b>9839-099</b>	50	1.02	0.61	FLUSH
3/4 x 1/2	625	<b>9839-101</b>	50	1.08	0.75	FLUSH
1 x 1/2	625	<b>9839-130</b>	25	1.24	0.76	FLUSH
1 x 3/4	625	<b>9839-131</b>	25	1.28	0.80	FLUSH
1 1/4 x 1	625	<b>9839-168</b>	25	1.30	1.00	FLUSH
1 1/2 x 3/4	625	<b>9839-210</b>	25	1.33	0.78	FLUSH
1 1/2 x 1	625	<b>9839-211</b>	25	1.34	0.98	FLUSH
1 1/2 x 1 1/4	625	<b>9839-212</b>	25	1.33	1.02	FLUSH
2 x 1	625	<b>9839-249</b>	10	1.42	0.97	FLUSH
2 x 1 1/4	625	<b>9839-250</b>	10	1.43	1.01	FLUSH
2 x 1 1/2	625	<b>9839-251</b>	10	1.35	1.02	FLUSH

Cap (S) Schedule 80 CORZAN® CPVC

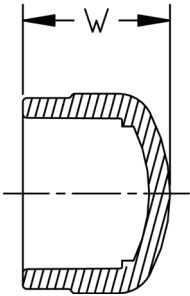

Size (inch)	P/L	Part No.	Pack Qty	W (inch)	Design
1/2	625	<b>9847-005</b>	50	1.30	HS
3/4	625	<b>9847-007</b>	25	1.46	HS
1	625	<b>9847-010</b>	25	1.66	HS
1 1/4	625	<b>9847-012</b>	15	1.89	HS
1 1/2	625	<b>9847-015</b>	10	2.08	HS
2	625	<b>9847-020</b>	5	2.32	HS
2 1/2	625	<b>9847-025</b>	5	2.61	HS
3	625	<b>9847-030</b>	5	3.06	HS
4	625	<b>9847-040</b>	5	3.69	HS
6	625	<b>9847-060</b>	2	4.86	HS
8	625	<b>9847-080</b>	2	6.25	SL
10	B10	<b>9847-100</b>	1	7.92	SL
12	B10	<b>9847-120</b>	1	9.37	SL
14	A34	<b>9847-140N</b>	1	5.75	FAB
16	A34	<b>9847-160N</b>	1	7.00	FAB
18	A34	<b>9847-180N</b>	1	8.25	FAB
20	A34	<b>9847-200N</b>	1	8.75	FAB
24	A34	<b>9847-240N</b>	1	10.25	FAB



**Cap (FPT) Schedule 80 CORZAN® CPVC**

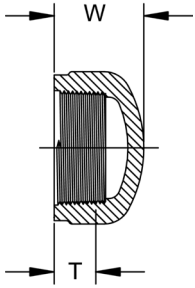
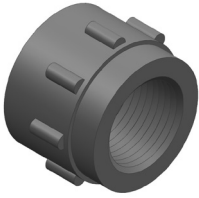

Size (inch)	P/L	Part No.	Pack Qty	W (inch)	T (inch)	Design
¼	625	<b>9848-002</b>	50	0.93	0.54	HS
⅜	625	<b>9848-003</b>	50	0.94	0.62	HS
½	625	<b>9848-005</b>	50	1.14	0.74	HS
¾	625	<b>9848-007</b>	25	1.25	0.80	HS
1	625	<b>9848-010</b>	25	1.51	0.97	HS
1 ¼	625	<b>9848-012</b>	15	1.59	1.00	HS
1 ½	625	<b>9848-015</b>	10	1.70	1.01	HS
2	625	<b>9848-020</b>	5	1.82	1.06	HS
2 ½	625	<b>9848-025</b>	5	2.61	1.45	HS

**Plug (MPT) Schedule 80 CORZAN® CPVC**

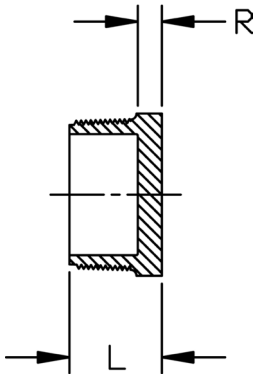
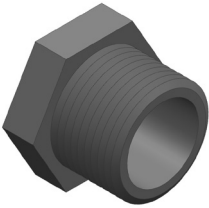

Size (inch)	P/L	Part No.	Pack Qty	L (inch)	R (inch)	Design
¼	625	<b>9850-002</b>	50	0.81	0.22	HS
⅜	625	<b>9850-003</b>	50	0.83	0.22	HS
½	625	<b>9850-005</b>	50	0.98	0.22	HS
¾	625	<b>9850-007</b>	50	1.06	0.25	HS
1	625	<b>9850-010</b>	25	1.24	0.27	HS
1 ¼	625	<b>9850-012</b>	25	1.33	0.31	HS
1 ½	625	<b>9850-015</b>	20	1.38	0.34	HS
2	625	<b>9850-020</b>	10	1.47	0.39	HS
3	625	<b>9850-030</b>	5	1.98	0.38	HS
4	625	<b>9850-040</b>	5	2.16	0.39	HS
6	A34	<b>9850-060N</b>	1	2.00	0.75	FAB
8	A34	<b>9850-080N</b>	1	2.00	0.75	FAB
10	A34	<b>9850-100N</b>	1	2.00	0.75	FAB
12	A34	<b>9850-120N</b>	1	2.00	0.75	FAB

### Flange - One Piece (S) Schedule 80 CORZAN® CPVC

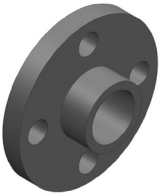

- ANSI 150 Class according to ANSI B16.5
- 150 psi @ 73°F (10.3 bar @ 22.7°C)
- HC = Honeycomb (Face)

Size (inch)	P/L	Part No.	Pack Qty	# holes	Bolt Dia. (inch)	bolt cir. dia. (inch)	D (inch)	L (inch)	N1 (inch)	R (inch)	Design
½	625	<b>9851-005</b>	5	4	½	2.38	3.50	1.03	0.13	0.39	HC
¾	625	<b>9851-007</b>	5	4	½	2.75	3.89	1.14	0.13	0.45	HC
1	625	<b>9851-010</b>	5	4	½	3.13	4.28	1.29	0.16	0.52	HC
1 ¼	625	<b>9851-012</b>	5	4	½	3.50	4.64	1.45	0.14	0.59	HC
1 ½	625	<b>9851-015</b>	5	4	½	3.88	5.01	1.54	0.16	0.68	HC
2	625	<b>9851-020</b>	5	4	¾	4.75	6.01	1.73	0.16	0.69	HC
2 ½	625	<b>9851-025</b>	5	4	¾	5.50	7.00	1.99	0.17	0.75	HC
3	625	<b>9851-030</b>	5	4	¾	6.00	7.51	2.46	0.57	1.10	HC
4	625	<b>9851-040</b>	5	8	¾	7.50	9.04	2.79	0.52	1.19	HC
6	625	<b>9851-060</b>	2	8	¾	9.50	11.13	3.86	0.36	1.38	HC

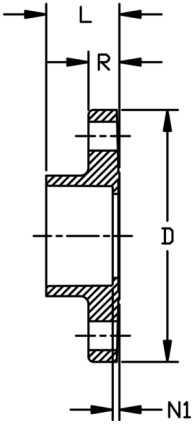

### Flange - One Piece (FPT) Schedule 80 CORZAN® CPVC

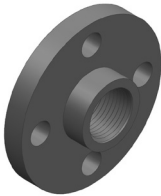

- ANSI 150 Class according to ANSI B16.5
- 150 psi @ 73°F (10.3 bar @ 22.7°C)
- HC = Honeycomb (Face)

Size (inch)	P/L	Part No.	Pack Qty	# holes	Bolt Dia. (inch)	bolt cir. dia. (inch)	D (inch)	L (inch)	T (inch)	R (inch)	Design
½	625	<b>9852-005</b>	5	4	½	2.38	3.51	0.89	0.77	0.39	HC
¾	625	<b>9852-007</b>	5	4	½	2.75	3.89	0.91	0.79	0.45	HC
1	625	<b>9852-010</b>	5	4	½	3.13	4.28	1.13	1.00	0.53	HC
1 ¼	625	<b>9852-012</b>	5	4	½	3.50	4.62	1.20	1.06	0.58	HC
1 ½	625	<b>9852-015</b>	5	4	½	3.88	4.99	1.19	1.03	0.68	HC
2	625	<b>9852-020</b>	5	4	¾	4.75	6.02	1.22	1.06	0.70	HC
2 ½	625	<b>9852-025</b>	5	4	¾	5.50	7.00	1.72	1.53	0.75	HC
3	625	<b>9852-030</b>	5	4	¾	6.00	7.50	2.15	1.63	1.15	HC
4	625	<b>9852-040</b>	5	8	¾	7.50	9.00	2.30	1.77	1.23	HC

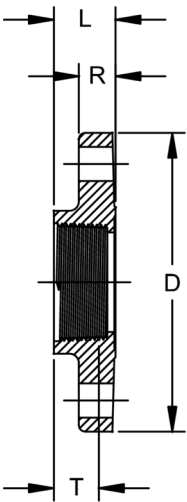

### Flange - Van Stone (S) Schedule 80 CORZAN® CPVC

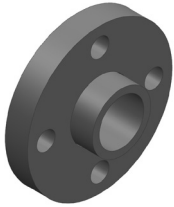

- ANSI 150 Class according to ANSI B16.5
- 1/2" - 12" pressure rating is 150 psi @ 73°F (10.3 bar @ 22.7°C)
- 14" - 24" pressure rating is 100 psi @ 73°F (6.9 bar @ 22.7°C) - Steel Ring
- HC = Honeycomb (Face)

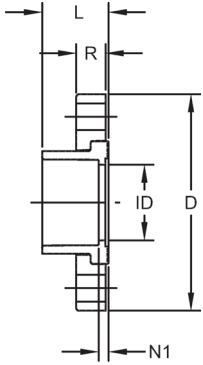

Size (inch)	P/L	Part No.	Pack Qty	# holes	Bolt Dia. (inch)	bolt cir. dia. (inch)	D (inch)	L (inch)	N1 (inch)	R (inch)	ID (inch)	Design
1/2	625	9854-005	5	4	1/2	2.38	3.53	1.10	0.18	0.57	0.60	HC
3/4	625	9854-007	5	4	1/2	2.75	3.87	1.23	0.18	0.59	0.82	HC
1	625	9854-010	5	4	1/2	3.13	4.25	1.38	0.20	0.66	1.03	HC
1 1/4	625	9854-012	5	4	1/2	3.50	4.62	1.52	0.21	0.69	1.36	HC
1 1/2	625	9854-015	5	4	1/2	3.88	5.01	1.68	0.25	0.75	1.60	HC
2	625	9854-020	5	4	5/8	4.75	6.02	1.84	0.29	0.82	2.06	HC
2 1/2	625	9854-025	5	4	5/8	5.50	7.01	2.15	0.33	0.98	2.49	HC
3	625	9854-030	5	4	5/8	6.00	7.50	2.33	0.39	1.02	3.09	HC
4	625	9854-040	5	8	5/8	7.50	8.99	2.75	0.24	1.10	4.06	HC
6	625	9854-060	2	8	3/4	9.50	10.98	3.55	0.48	1.25	6.11	HC
8	625	9854-080	2	8	3/4	11.75	13.51	4.60	0.51	1.71	8.00	HC
10	B10	9854-100	2	12	7/8	14.25	15.97	5.66	0.53	1.73	10.10	HC
12	B10	9854-120	2	12	7/8	17.00	18.95	6.71	0.57	1.72	11.96	HC
14	A34	9854-140N	1	12	7/8	18.75	21.00	11.75	4.75	0.50	12.50	FAB
16	A34	9854-160N	1	16	1	21.25	23.50	13.50	5.50	0.50	14.31	FAB
18	A34	9854-180N	1	16	1 1/8	22.75	25.00	14.50	5.50	0.50	16.13	FAB
20	A34	9854-200N	1	20	1 1/8	25.00	27.50	17.25	7.25	0.50	18.00	FAB
24	A34	9854-240N	1	20	1 1/4	29.50	32.00	19.50	7.50	0.50	21.56	FAB

### Flange - Van Stone (FPT) Schedule 80 CORZAN® CPVC

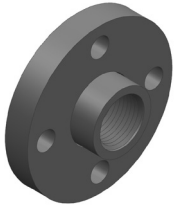

- ANSI 150 Class according to ANSI B16.5
- 150 psi @ 73°F (10.3 bar @ 22.7°C)
- HC = Honeycomb (Face)

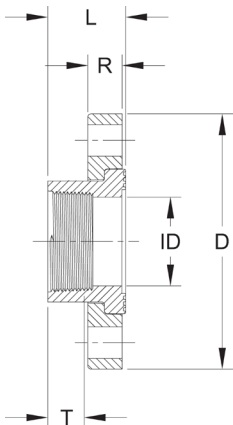

Size (inch)	P/L	Part No.	Pack Qty	# holes	Bolt Dia. (inch)	bolt cir. dia. (inch)	D (inch)	L (inch)	T (inch)	R (inch)	ID (inch)	Design
1	625	9855-010	5	4	1/2	3.13	4.25	1.39	1.01	0.66	1.06	HC
1 1/4	625	9855-012	5	4	1/2	3.50	4.62	1.50	1.02	0.69	1.38	HC
1 1/2	625	9855-015	5	4	1/2	3.88	5.01	1.67	1.06	0.75	1.61	HC
2	625	9855-020	5	4	5/8	4.75	6.02	1.82	1.09	0.82	2.08	HC

### Flange - Van Stone (SPG) Schedule 80 CORZAN® CPVC

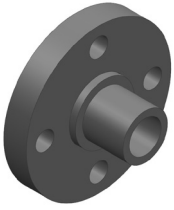

- ANSI 150 Class according to ANSI B16.5
- 1/2" - 12" pressure rating is 150 psi @ 73°F (10.3 bar @ 22.7°C)
- 14" - 24" pressure rating is 100 psi @ 73°F (6.9 bar @ 22.7°C) - Steel Ring
- HC = Honeycomb (Face)

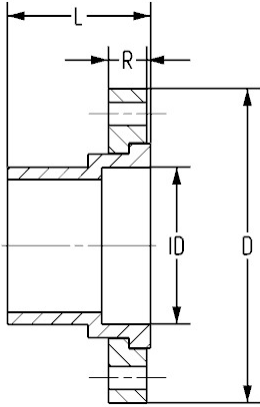

Size (inch)	P/L	Part No.	Pack Qty	# holes	Bolt Dia. (inch)	bolt cir. dia. (inch)	D (inch)	L (inch)	R (inch)	ID (inch)	Design
1/2	625	9856-005	5	4	1/2	2.38	3.53	1.72	0.57	0.84	HC
3/4	625	9856-007	5	4	1/2	2.75	3.87	1.85	0.59	1.05	HC
1	625	9856-010	5	4	1/2	3.13	4.25	2.10	0.66	1.32	HC
1 1/4	625	9856-012	5	4	1/2	3.50	4.62	2.28	0.69	1.66	HC
1 1/2	625	9856-015	5	4	1/2	3.88	5.01	2.48	0.75	1.90	HC
2	625	9856-020	5	4	5/8	4.75	6.02	2.80	0.82	2.38	HC
2 1/2	625	9856-025	5	4	5/8	5.50	7.01	3.27	0.98	2.86	HC
3	625	9856-030	5	4	5/8	6.00	7.50	3.60	1.02	3.49	HC
4	625	9856-040	5	8	5/8	7.50	8.99	4.10	1.10	4.49	HC
6	625	9856-060	2	8	3/4	9.50	10.98	5.10	1.25	6.60	HC
8	625	9856-080	1	8	3/4	11.75	13.51	6.88	1.71	8.62	HC
10	B10	9856-100	1	12	7/8	14.25	15.97	8.30	1.73	10.70	HC
12	B10	9856-120	1	12	7/8	17.00	18.95	9.55	1.72	12.69	HC
14	A34	9856-140N	1	12	1	18.75	21.00	13.00	0.50	11.41	FAB
16	A34	9856-160N	1	16	1	21.25	23.50	14.00	0.50	13.08	FAB
18	A34	9856-180N	1	16	1 1/8	22.75	25.00	16.00	0.50	14.76	FAB
20	A34	9856-200N	1	20	1 1/8	25.00	27.50	18.00	0.50	16.43	FAB
24	A34	9856-240N	1	20	1 1/4	29.50	32.00	20.00	0.50	19.79	FAB

### Flange (Blind) Schedule 80 CORZAN® CPVC

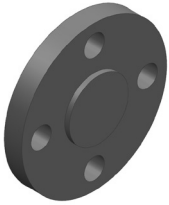

- ANSI 150 Class according to ANSI B16.5
- 1/2" - 8" 150 psi @ 73°F (10.3 bar @ 22.7°C)
- 10" - 24" 50 psi @ 73°F (3.5 bar @ 22.7°C)
- HC = Honeycomb (Face)

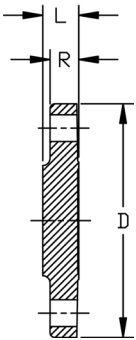

Size (inch)	P/L	Part No.	Pack Qty	# holes	Bolt Dia. (inch)	bolt cir. dia. (inch)	D (inch)	L (inch)	R (inch)	Design
1/2	625	9853-005	5	4	1/2	2.38	3.51	0.48	0.39	HC
3/4	625	9853-007	5	4	1/2	2.75	3.90	0.55	0.45	HC
1	625	9853-010	5	4	1/2	3.13	4.29	0.66	0.53	HC
1 1/4	625	9853-012	5	4	1/2	3.50	4.62	0.73	0.59	HC
1 1/2	625	9853-015	5	4	1/2	3.88	5.01	0.81	0.68	HC
2	625	9853-020	5	4	5/8	4.75	6.02	0.90	0.70	HC
2 1/2	625	9853-025	5	4	5/8	5.50	7.00	0.97	0.76	HC
3	625	9853-030	5	4	5/8	6.00	7.47	0.96	1.03	HC
4	625	9853-040	5	8	5/8	7.50	8.87	1.05	1.00	HC
6	625	9853-060	2	8	3/4	9.50	10.89	1.42	1.17	HC
8	625	9853-080	2	8	3/4	11.75	13.51	1.51	1.31	HC
10	A34	9853-100N	1	12	7/8	14.25	16.00	1.00	1.00	SOLID
12	A34	9853-120N	1	12	7/8	17.00	19.00	1.00	1.00	SOLID
14	A34	9853-140N	1	12	1	18.75	21.00	1.00	1.00	SOLID
16	A34	9853-160N	1	16	1	21.25	23.50	1.00	1.00	SOLID
18	A34	9853-180N	1	16	1 1/8	22.75	25.00	1.00	1.00	SOLID
20	A34	9853-200N	1	20	1 1/8	25.00	27.50	1.00	1.00	SOLID
24	A34	9853-240N	1	20	1 1/4	29.50	32.00	1.00	1.00	SOLID

### Flange - Van Stone 300 (S) Schedule 80 CORZAN® CPVC

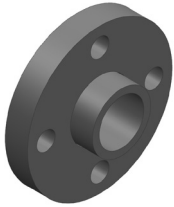

- ANSI 300 Class according to ANSI B16.5
- 150 psi @ 73°F (10.3 bar @ 22.7°C)
- HC = Honeycomb (Face)

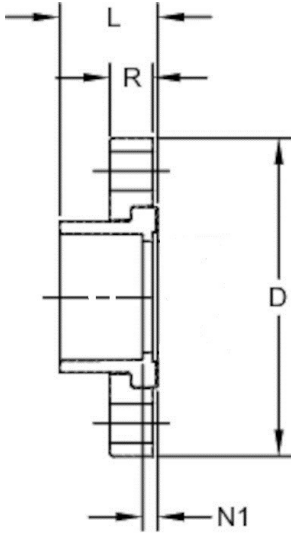

Size (inch)	P/L	Part No.	Pack Qty	# holes	Bolt Dia. (inch)	bolt cir. dia. (inch)	D (inch)	L (inch)	N1 (inch)	R (inch)	Design
½	25	<b>9854-005-300</b>	1	4	½	2.63	3.75	1.03	0.11	0.57	FAB
¾	25	<b>9854-007-300</b>	1	4	⅝	3.25	4.63	1.15	0.13	0.59	FAB
1	25	<b>9854-010-300</b>	1	4	⅝	3.50	4.88	1.38	0.11	0.66	FAB
1 ¼	25	<b>9854-012-300</b>	1	4	⅝	3.88	5.25	1.45	0.14	0.69	FAB
1 ½	25	<b>9854-015-300</b>	1	4	¾	4.50	6.13	1.59	0.15	0.75	FAB
2	25	<b>9854-020-300</b>	1	8	⅝	5.00	6.50	1.76	0.20	0.82	FAB
2 ½	25	<b>9854-025-300</b>	1	8	¾	5.88	7.50	2.05	0.22	0.98	FAB
3	25	<b>9854-030-300</b>	1	8	¾	6.63	8.25	2.25	0.30	1.02	FAB
4	25	<b>9854-040-300</b>	1	8	¾	7.88	10.00	2.65	0.34	1.10	FAB
6	25	<b>9854-060-300</b>	1	12	¾	10.63	12.50	3.45	0.35	1.25	FAB
8	25	<b>9854-080-300</b>	1	12	⅞	13.00	15.00	4.50	0.40	1.71	FAB
10	02	<b>9854-100-300</b>	1	16	1	15.25	17.50	5.63	0.50	1.73	FAB
12	02	<b>9854-120-300</b>	1	16	1 ⅛	17.75	20.50	6.69	0.56	1.72	FAB

### Union Type 375 (S x S) Schedule 80 CORZAN® CPVC

235 psi @ 73°F (16.2 bar @ 22.7°C)

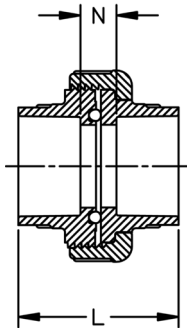

Size (inch)	P/L	EPDM Part No.	FKM Part No.	Pack Qty	L (inch)	N (inch)
½	625	<b>9897-375-005</b>	<b>9857-375-005</b>	5	2.56	0.78
¾	625	<b>9897-375-007</b>	<b>9857-375-007</b>	5	2.80	0.76
1	625	<b>9897-375-010</b>	<b>9857-375-010</b>	5	3.22	0.89
1 ¼	625	<b>9897-375-012</b>	<b>9857-375-012</b>	5	3.56	0.99
1 ½	625	<b>9897-375-015</b>	<b>9857-375-015</b>	5	3.76	0.92
2	625	<b>9897-375-020</b>	<b>9857-375-020</b>	2	4.18	1.11



### Union (S x S) Schedule 80 CORZAN® CPVC

150 psi @ 73°F (10.3 bar @ 22.7°C)

Size (inch)	P/L	EPDM Part No.	FKM Part No.	Pack Qty	L (inch)	N (inch)
3	625	<b>9897-030</b>	<b>9857-030</b>	1	4.74	0.96
4	625	<b>9897-040</b>	<b>9857-040</b>	1	5.62	1.11

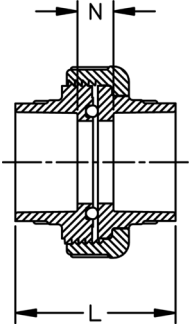

### Union Type 375 (FPT X FPT) Schedule 80 CORZAN® CPVC

• 235 psi @ 73°F (16.2 bar @ 22.7°C)

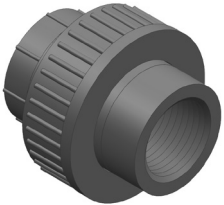

Size (inch)	P/L	EPDM Part No.	FKM Part No.	Pack Qty	L (inch)	T (inch)
½	625	<b>9898-375-005</b>	<b>9858-375-005</b>	5	2.06	0.75
¾	625	<b>9898-375-007</b>	<b>9858-375-007</b>	5	2.11	0.79
1	625	<b>9898-375-010</b>	<b>9858-375-010</b>	5	2.60	1.01
1 ¼	625	<b>9898-375-012</b>	<b>9858-375-012</b>	5	2.80	1.06
1 ½	625	<b>9898-375-015</b>	<b>9858-375-015</b>	5	2.76	1.06
2	625	<b>9898-375-020</b>	<b>9858-375-020</b>	2	2.93	1.09

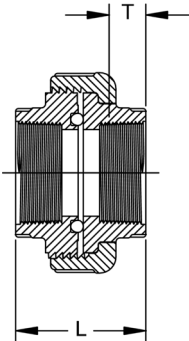





### Union (FPT X FPT) Schedule 80 CORZAN® CPVC

- 150 psi @ 73°F (10.3 bar @ 22.7°C)

Size (inch)	P/L	EPDM Part No.	FKM Part No.	Pack Qty	L (inch)	T (inch)
3	625	<b>9898-030</b>	<b>9858-030</b>	1	4.75	1.33
4	625	<b>9898-040</b>	<b>9858-040</b>	1	5.71	1.78

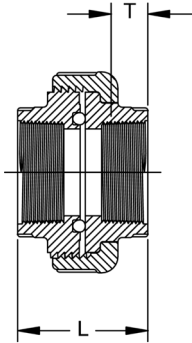

### Nipple (MPT x MPT) Schedule 80 CORZAN® CPVC

- Nipples fabricated from pipe

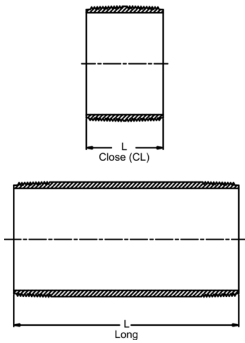
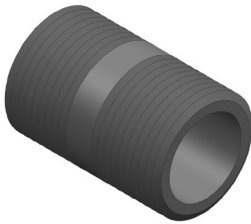

Size (inch)	P/L	Part No.	Pack Qty	L (inch)
1/2 x CL	625	<b>9861-077</b>	25	1.13
1/2 x 2	625	<b>9861-079</b>	25	2.00
1/2 x 3	625	<b>9861-081</b>	25	3.00
1/2 x 4	625	<b>9861-082</b>	25	4.00
1/2 x 5	625	<b>9861-083</b>	25	5.00
1/2 x 6	625	<b>9861-084</b>	25	6.00
1/2 x 8	625	<b>9861-086</b>	25	8.00
3/4 x CL	625	<b>9861-104</b>	25	1.38
3/4 x 2	625	<b>9861-020</b>	25	2.00
3/4 x 3	625	<b>9861-106</b>	25	3.00
3/4 x 4	625	<b>9861-107</b>	25	4.00
3/4 x 5	625	<b>9861-108</b>	25	5.00
3/4 x 6	625	<b>9861-109</b>	25	6.00
3/4 x 8	625	<b>9861-112</b>	25	8.00
1 x CL	625	<b>9861-133</b>	25	1.50
1 x 2	625	<b>9861-134</b>	25	2.00
1 x 3	625	<b>9861-135</b>	25	3.00
1 x 4	625	<b>9861-136</b>	25	4.00
1 x 5	625	<b>9861-137</b>	25	5.00
1 x 6	625	<b>9861-138</b>	25	6.00
1 1/4 x CL	625	<b>9861-170</b>	25	1.63
1 1/4 x 2	625	<b>9861-171</b>	25	2.00
1 1/4 x 3	625	<b>9861-172</b>	25	3.00
1 1/4 x 4	625	<b>9861-173</b>	25	4.00
1 1/4 x 5	625	<b>9861-174</b>	25	5.00
1 1/4 x 6	625	<b>9861-175</b>	25	6.00
1 1/2 x CL	625	<b>9861-213</b>	25	1.75
1 1/2 x 2	625	<b>9861-214</b>	25	2.00
1 1/2 x 3	625	<b>9861-215</b>	25	3.00
1 1/2 x 4	625	<b>9861-216</b>	25	4.00
1 1/2 x 5	625	<b>9861-217</b>	25	5.00
1 1/2 x 6	625	<b>9861-218</b>	25	6.00
1-1/2 x 12	625	<b>9861-221</b>	25	12.00
2 x CL	625	<b>9861-251</b>	25	2.00

table continued on the next page

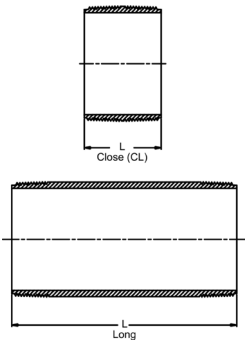

Size (inch)	P/L	Part No.	Pack Qty	L (inch)
2 x 2 1/2	625	<b>9861-252</b>	25	2.50
2 x 3	625	<b>9861-253</b>	25	3.00
2 x 4	625	<b>9861-254</b>	25	4.00
2 x 5	625	<b>9861-255</b>	25	5.00
2 x 6	625	<b>9861-256</b>	25	6.00
2 x 12	625	<b>9861-259</b>	25	12.00
2 1/2 x CL	625	<b>9861-291</b>	10	2.50
2 1/2 x 3	625	<b>9861-292</b>	10	3.00
2 1/2 x 4	625	<b>9861-295</b>	10	4.00
2 1/2 x 5	625	<b>9861-296</b>	10	5.00
2 1/2 x 6	625	<b>9861-297</b>	10	6.00
3 x CL	625	<b>9861-338</b>	10	2.63
3 x 3	625	<b>9861-340</b>	10	3.00
3 x 4	625	<b>9861-341</b>	10	4.00
3 x 5	625	<b>9861-342</b>	10	5.00
3 x 6	625	<b>9861-343</b>	10	6.00
4 x CL	625	<b>9861-422</b>	10	2.88
4 x 4	625	<b>9861-423</b>	10	4.00
4 x 5	625	<b>9861-425</b>	10	5.00
4 x 6	625	<b>9861-426</b>	10	6.00

# ChlorFIT® Schedule 80 CPVC DWV Fittings



1/4 Bend Short Sweep (SxS) Schedule 80 CORZAN® CPVC

Size (inch)	P/L	Part No.	Pack Qty	G (inch)
1 1/2	625	<b>9806-015SS</b>	4	1.75
2	625	<b>9806-020SS</b>	4	2.31
3	625	<b>9806-030SS</b>	1	3.06
4	625	<b>9806-040SS</b>	1	3.88

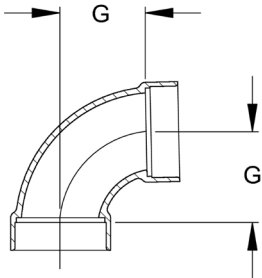

1/4 Bend Long Sweep (SxS) - FAB Schedule 80 CORZAN® CPVC



Size (inch)	P/L	Part No.	Pack Qty	G (inch)
1 1/2	A34	<b>9806-015LSN</b>	4	4.13
2	A34	<b>9806-020LSN</b>	4	4.75
3	A34	<b>9806-030LSN</b>	1	7.00
4	A34	<b>9806-040LSN</b>	1	9.00

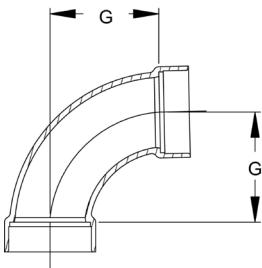

45° Wye (S x S x S) Schedule 80 CORZAN® CPVC

1-1/2" - 2" 235 psi @ 72°F (16.2 bar @ 22.7°C)  
 3" - 6" 150 psi @ 72°F (10.3 bar @ 22.7°C)  
 8" - 24" 100 psi @ 72°F (6.9 bar @ 22.7°C)

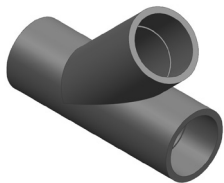

Size (inch)	P/L	Part No.	Pack Qty	GJ (inch)	GN (inch)	H (inch)	HJ (inch)	L (inch)	N (inch)	Design
1 1/2	625	<b>9870-015</b>	20	2.79	1.20	2.60	4.18	6.80	4.02	SL
2	625	<b>9870-020</b>	10	3.56	1.36	2.87	5.07	7.99	4.97	SL
3	625	<b>9870-030</b>	4	4.91	1.82	3.73	6.83	10.45	6.62	SL
4	625	<b>9870-040</b>	4	6.26	2.06	4.41	8.61	12.94	8.24	SL
6	625	<b>9870-060</b>	2	8.38	1.85	4.90	11.44	16.50	10.39	HS
10	A34	<b>9875-100N</b>	1	19.75	5.50	11.25	24.75	31.75	21.75	FAB
12	A34	<b>9875-120N</b>	1	22.63	6.50	12.50	28.63	37.50	25.50	FAB
14	A34	<b>9875-140N</b>	1	25.75	7.00	14.00	32.75	41.75	27.75	FAB
16	A34	<b>9875-160N</b>	1	28.88	7.75	16.00	36.88	47.25	31.25	FAB
18	A34	<b>9875-180N</b>	1	32.50	8.50	17.50	41.50	53.00	35.00	FAB
20	A34	<b>9875-200N</b>	1	35.50	9.50	19.50	45.50	58.75	38.75	FAB
24	A34	<b>9875-240N</b>	1	42.00	11.00	23.00	54.00	70.00	46.00	FAB

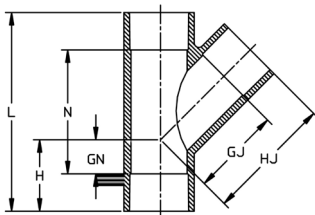

**Reducing 45° Wye (S x S x S) Schedule 80 CORZAN® CPVC**



2" 235 psi @ 72°F (16.2 bar @ 22.7° C)  
 3" - 6" 150 psi @ 72°F (10.3 bar @ 22.7°C)  
 8" - 24" 100 psi @ 72°F (6.9 bar @ 22.7°C)

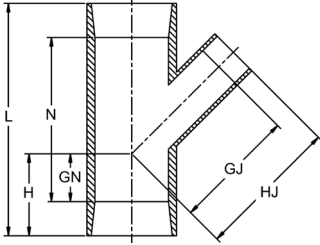

Size (inch)	P/L	Part No.	Pack Qty	GJ (inch)	GN (inch)	H (inch)	HJ (inch)	L (inch)	N (inch)	Design
2 x 1 1/2	625	9870-251FB	10	3.96	1.36	2.87	5.37	7.99	4.97	BUSH
3 x 1 1/2	625	9870-337FB	4	5.80	1.82	3.73	7.34	10.45	6.62	BUSH
3 x 2	625	9870-338FB	4	5.77	1.82	3.73	7.33	10.45	6.62	BUSH
4 x 2	625	9870-420FB	4	7.40	2.06	4.41	7.40	12.94	8.24	BUSH
4 x 3	625	9870-422FB	4	7.03	2.06	4.41	9.00	12.94	8.24	BUSH
6 x 2	625	9870-528FB	1	8.24	1.87	4.91	8.24	16.49	10.42	BUSH
6 x 3	625	9870-530FB	2	7.88	1.87	4.91	9.84	16.49	10.42	BUSH
6 x 4	625	9870-532	2	7.14	1.87	4.91	9.36	16.49	10.42	HS
8 x 3	625	9870-580FB	1	10.23	0.41	4.43	12.20	15.98	7.95	BUSH
8 x 4	625	9870-582FB	1	13.95	2.06	6.06	16.21	21.25	13.31	BUSH
8 x 6	625	9870-585FB	1	12.78	1.90	5.92	15.76	21.35	13.30	BUSH
10 x 4	A34	9875-623N	1	14.00	1.25	6.25	16.00	23.00	13.00	FAB
10 x 6	A34	9875-626N	1	16.13	2.75	7.50	19.13	26.00	16.00	FAB
10 x 8	A34	9875-628N	1	17.50	4.00	9.25	21.50	28.00	18.75	FAB
12 x 4	A34	9875-663N	1	15.50	0.50	6.00	17.50	25.75	13.75	FAB
12 x 6	A34	9875-666N	1	16.68	2.00	8.00	20.50	28.68	16.68	FAB
12 x 8	A34	9875-668N	1	19.00	3.50	9.50	23.00	31.50	19.50	FAB
12 x 10	A34	9875-670N	1	21.25	5.00	11.00	26.25	34.50	22.50	FAB
14 x 4	A34	9875-696N	1	16.25	0.25	7.25	18.25	28.25	14.25	FAB
14 x 6	A34	9875-698N	1	18.50	1.75	8.63	21.50	31.25	17.25	FAB
14 x 8	A34	9875-700N	1	19.75	3.00	10.00	23.75	34.00	20.00	FAB
14 x 10	A34	9875-702N	1	22.00	4.50	11.50	27.00	37.00	23.00	FAB
14 x 12	A34	9875-704N	1	23.50	6.00	13.00	29.50	39.75	25.75	FAB
16 x 4	A34	9875-730N	1	17.75	-0.75	7.50	19.75	31.00	15.00	FAB
16 x 6	A34	9875-732N	1	19.88	1.00	9.00	22.88	34.00	18.00	FAB
16 x 8	A34	9875-734N	1	21.25	2.50	10.25	25.25	36.75	20.75	FAB
16 x 10	A34	9875-736N	1	23.50	4.00	12.00	28.50	39.75	23.75	FAB
16 x 12	A34	9875-738N	1	25.00	5.50	14.25	31.00	42.75	26.75	FAB
16 x 14	A34	9875-740N	1	27.25	6.25	15.25	34.25	44.50	28.50	FAB
18 x 4	A34	9875-784N	1	19.00	-1.25	8.00	21.00	34.00	16.00	FAB
18 x 6	A34	9875-786N	1	21.25	0.50	9.50	24.25	37.00	19.00	FAB
18 x 8	A34	9875-788N	1	22.75	2.00	11.00	26.75	39.75	21.75	FAB
18 x 10	A34	9875-790N	1	25.00	3.50	12.50	30.00	42.75	24.75	FAB
18 x 12	A34	9875-792N	1	26.25	4.75	13.75	32.50	45.50	27.50	FAB
18 x 14	A34	9875-794N	1	28.75	5.75	14.75	35.75	48.50	29.50	FAB
18 x 16	A34	9875-796N	1	30.25	7.25	16.00	38.25	50.25	32.25	FAB
20 x 4	A34	9875-814N	1	20.50	-1.75	8.50	22.50	36.75	16.75	FAB
20 x 6	A34	9875-816N	1	22.75	-0.25	10.00	25.75	39.75	19.75	FAB
20 x 8	A34	9875-818N	1	24.25	1.50	11.50	28.25	42.75	22.75	FAB
20 x 10	A34	9875-820N	1	26.50	3.00	13.00	31.50	45.75	25.75	FAB
20 x 12	A34	9875-822N	1	28.00	4.25	14.25	34.00	48.50	28.50	FAB
20 x 14	A34	9875-824N	1	30.25	5.25	15.00	37.25	50.25	30.25	FAB
20 x 16	A34	9875-826N	1	31.75	6.50	16.50	39.75	53.00	33.00	FAB
20 x 18	A34	9875-828N	1	34.00	8.00	18.00	43.00	56.00	36.00	FAB
24 x 4	A34	9875-904N	1	23.25	-3.00	9.25	25.25	42.50	18.50	FAB
24 x 6	A34	9875-906N	1	25.50	-1.50	10.75	28.50	45.50	21.54	FAB
24 x 8	A34	9875-908N	1	27.00	0.00	12.00	31.00	48.25	24.25	FAB
24 x 10	A34	9875-910N	1	29.25	1.75	13.50	34.25	51.25	27.25	FAB
24 x 12	A34	9875-912N	1	30.50	3.25	15.00	36.60	54.25	30.25	FAB
24 x 14	A34	9875-914N	1	33.00	4.00	16.00	40.00	56.00	32.00	FAB
24 x 16	A34	9875-916N	1	34.50	5.50	17.50	42.50	58.75	34.75	FAB
24 x 18	A34	9875-918N	1	36.75	6.75	18.75	45.75	61.50	37.50	FAB
24 x 20	A34	9875-920N	1	38.25	8.25	20.25	48.25	64.50	40.50	FAB



### Sanitary Tee (SxSxS) Schedule 80 CORZAN® CPVC

Size (inch)	P/L	Part No.	Pack Qty	G (inch)	N (inch)
1 1/2	625	<b>37S461501</b>	5	1.75	2.75
2	625	<b>37S461502</b>	5	2.31	3.69
3	625	<b>37S461503</b>	5	3.06	4.88
4	625	<b>37S461504</b>	5	3.88	6.13

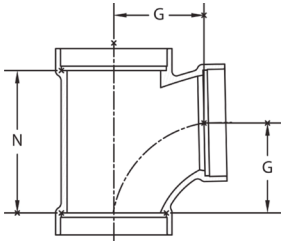

### Cleanout Tee with Plug (SxSxFPT) Schedule 80 CORZAN® CPVC

Size (inch)	P/L	Part No.	Pack Qty	HL (inch)	N (inch)
1 1/2	625	<b>37S461101</b>	2	2.07	1.80
2	625	<b>37S461102</b>	2	2.35	2.32
3	625	<b>37S461103</b>	2	3.51	3.63
4	625	<b>37S461104</b>	2	4.07	4.25

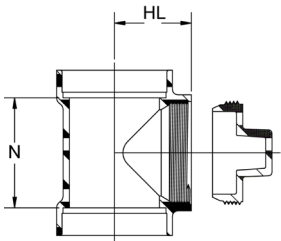

# ChlorFIT® Schedule 80 CPVC Metal Transition Fittings

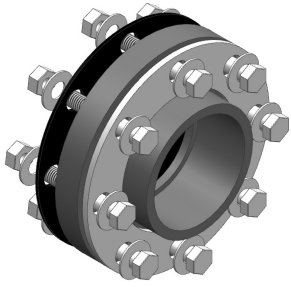

## Full Pressure Flange Kit Schedule 80 CORZAN® CPVC

- Kit includes: 1 Van Stone Flange, 1 304SS Backing Ring, 1 Garlock Stress Saver XP Gasket, and appropriate number of bolts, nuts, and washers depending on the size.

Size (inch)	P/L	Part No.	Pack Qty	Max Pressure at 73°F (22.7°C) (psi)	Weight (lb)
2 ½	607	<b>37Z000267</b>	1	420	3.44
3	607	<b>37Z000268</b>	1	370	3.81
4	607	<b>37Z000269</b>	1	320	6.94
6	607	<b>37Z000270</b>	1	280	9.17

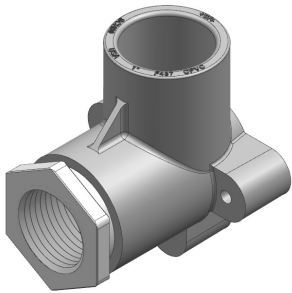

## Drop Ear (SxFPT) Schedule 80 CORZAN® CPVC-to-316SS

- 400 psi @ 73°F (27.6 bar @ 22.7°C)

Size (inch)	P/L	Part No.	Pack Qty	G (inch)	HJ (inch)	HN (inch)	T (inch)	W (inch)
½	A35	<b>9832-005SS</b>	5	0.62	1.50	1.52	0.90	1.125
¾	A35	<b>9832-007SS</b>	5	0.76	1.77	1.65	0.95	1.313
1	A35	<b>9832-010SS</b>	5	0.87	2.00	2.20	1.00	1.750

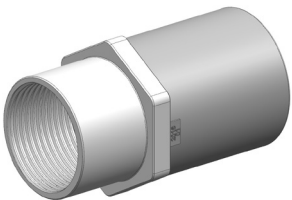
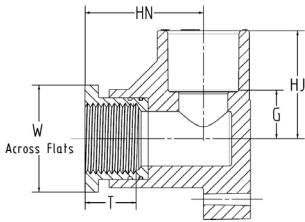

## Female Adapter (SxFPT) Schedule 80 CORZAN® CPVC-to-316SS

- 400 psi @ 73°F (27.6 bar @ 22.7°C)

Size (inch)	P/L	Part No.	Pack Qty	HL (inch)	L (inch)	T (inch)	W (inch)
½	A35	<b>9868-005SS</b>	10	1.49	2.38	0.84	1.25
¾	A35	<b>9868-007SS</b>	10	1.67	2.68	0.92	1.50
1	A35	<b>9868-010SS</b>	6	1.98	3.11	0.96	1.75
1 ¼	A35	<b>9868-012SS</b>	5	2.19	3.45	1.04	2.12
1 ½	A35	<b>9868-015SS</b>	5	2.35	3.73	1.04	2.50
2	A35	<b>9868-020SS</b>	4	2.63	4.14	1.29	3.00

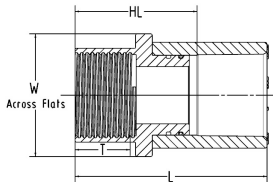



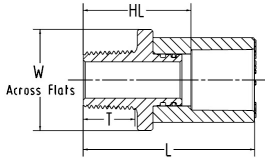
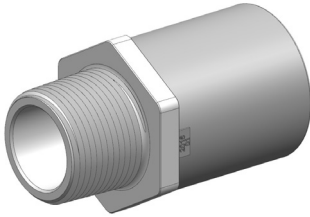

### Male Adapter (SxMPT) Schedule 80 CORZAN® CPVC-to-316SS

- 400 psi @ 73°F (27.6 bar @ 22.7°C)

Size (inch)	P/L	Part No.	Pack Qty	HL (inch)	L (inch)	T (inch)	W (inch)
½	A35	<b>9869-005SS</b>	10	1.49	2.38	0.70	1.25
¾	A35	<b>9869-007SS</b>	10	1.67	2.68	0.74	1.50
1	A35	<b>9869-010SS</b>	6	1.98	3.11	0.92	1.75
1 ¼	A35	<b>9869-012SS</b>	5	2.19	3.45	0.95	2.12
1 ½	A35	<b>9869-015SS</b>	5	2.35	3.73	0.99	2.50
2	A35	<b>9869-020SS</b>	4	2.64	4.14	1.03	3.00



### Metal Union End Connectors for Type 375 Union or Ball Valve (316 SS)

- Not Fully Pressure Rated**  
 150 psi @ 73°F (10.3 bar @ 22.7°C)  
 Union Sold Separately

Size (inch)	P/L	Part No.	Pack Qty
½	A35	<b>37X003314</b>	1
¾	A35	<b>37X003315</b>	1
1	A35	<b>37X003316</b>	1
1 ¼	A35	<b>37X003317</b>	1
1 ½	A35	<b>37X003318</b>	1
2	A35	<b>37X003319</b>	1

### Transition Fittings (SPG x FPT) Schedule 80 CORZAN® CPVC-to-Brass

- 150 psi @ 73°F (10.3 bar @ 22.7°C)

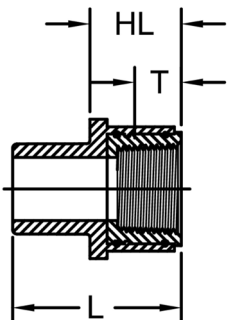
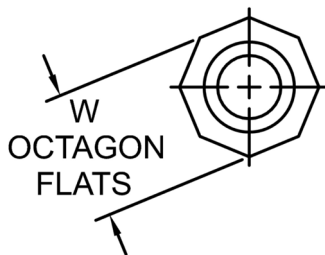
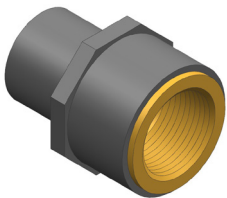

Size (inch)	P/L	Part No.	Pack Qty	HL (inch)	L (inch)	T (inch)	W (inch)
½	A35	<b>9878-005BR</b>	25	1.02	1.75	0.70	1.27
¾	A35	<b>9878-007BR</b>	15	1.07	2.07	0.74	1.52
1	A35	<b>9878-010BR</b>	15	1.32	2.44	0.81	1.93
1 ¼	A35	<b>9878-012BR</b>	15	1.38	2.49	0.85	2.29
1 ½	A35	<b>9878-015BR</b>	10	1.44	2.74	0.87	2.60
2	A35	<b>9878-020BR</b>	5	1.43	2.81	1.11	3.36

**Transition Fittings (SPG x FPT) Schedule 80 CORZAN® CPVC-to-316SS**

150 psi @ 73°F (10.3 bar @ 22.7°C)

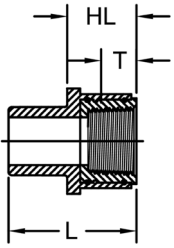
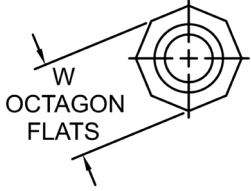
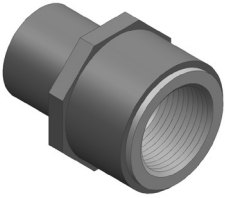

Size (inch)	P/L	Part No.	Pack Qty	HL (inch)	L (inch)	T (inch)	W (inch)
½	A35	<b>9878-005SS</b>	25	1.02	1.75	0.70	1.27
¾	A35	<b>9878-007SS</b>	15	1.07	2.07	0.74	1.52
1	A35	<b>9878-010SS</b>	15	1.32	2.44	0.81	1.93
1 ¼	A35	<b>9878-012SS</b>	15	1.38	2.49	0.85	2.29
1 ½	A35	<b>9878-015SS</b>	10	1.45	2.74	0.87	2.60
2	A35	<b>9878-020SS</b>	5	1.43	2.81	1.11	3.36

# ChlorFIT® Schedule 80 CPVC Expansion Joints

## Expansion Joint 6" Travel (S x S) Schedule 80 CORZAN® CPVC

To order SxSPG add "P" to end of part number.  
To order FxF add "F" to end of part number.

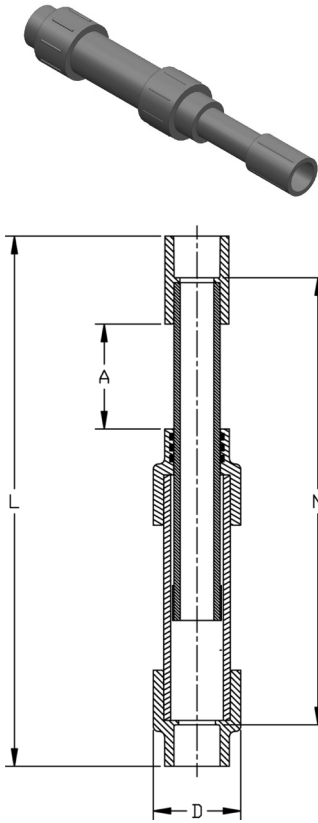

Size (inch)	P/L	EPDM Part No.	FKM Part No.	A (inch)	D (inch)	L (inch)	N (inch)
½	634	9826-005X6	9836-005X6	3.00	1.86	13.97	12.17
¾	634	9826-007X6	9836-007X6	3.00	2.23	14.44	12.40
1	634	9826-010X6	9836-010X6	3.00	2.50	14.98	12.69
1 ¼	634	9826-012X6	9836-012X6	3.00	2.89	15.56	12.98
1 ½	634	9826-015X6	9836-015X6	3.00	3.51	16.00	13.21
2	634	9826-020X6	9836-020X6	3.00	4.40	18.05	15.01
3	634	9826-030X6	9836-030X6	3.00	5.52	19.75	16.00
4	634	9826-040X6	9836-040X6	3.00	7.92	28.29	23.76
6	634	9826-060X6	9836-060X6	3.00	9.80	27.79	21.73
8	634	9826-080X6	9836-080X6	3.00	10.75	25.35	17.31
10	634	9826-100X6	9836-100X6	3.00	12.75	29.64	19.60

## Expansion Joint 12" Travel (S x S) Schedule 80 CORZAN® CPVC

To order SxSPG add "P" to end of part number.  
To order FxF add "F" to end of part number.

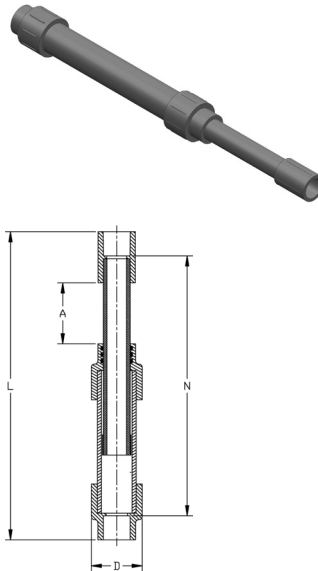

Size (inch)	P/L	EPDM Part No.	FKM Part No.	A (inch)	D (inch)	L (inch)	N (inch)
½	634	9826-005X12	9836-005X12	6.00	1.86	23.10	21.30
¾	634	9826-007X12	9836-007X12	6.00	2.23	23.57	21.52
1	634	9826-010X12	9836-010X12	6.00	2.50	24.11	21.81
1 ¼	634	9826-012X12	9836-012X12	6.00	2.89	24.69	22.11
1 ½	634	9826-015X12	9836-015X12	6.00	3.51	25.12	22.34
2	634	9826-020X12	9836-020X12	6.00	4.40	27.05	24.01
3	634	9826-030X12	9836-030X12	6.00	5.52	28.75	25.00
4	634	9826-040X12	9836-040X12	6.00	7.92	37.28	32.76
6	634	9826-060X12	9836-060X12	6.00	9.80	26.79	30.73
8	634	9826-080X12	9836-080X12	6.00	10.75	28.35	20.31
10	634	9826-100X12	9836-100X12	6.00	12.75	32.64	22.60



**Section 3**

# Schedule 40 PVC Piping Systems

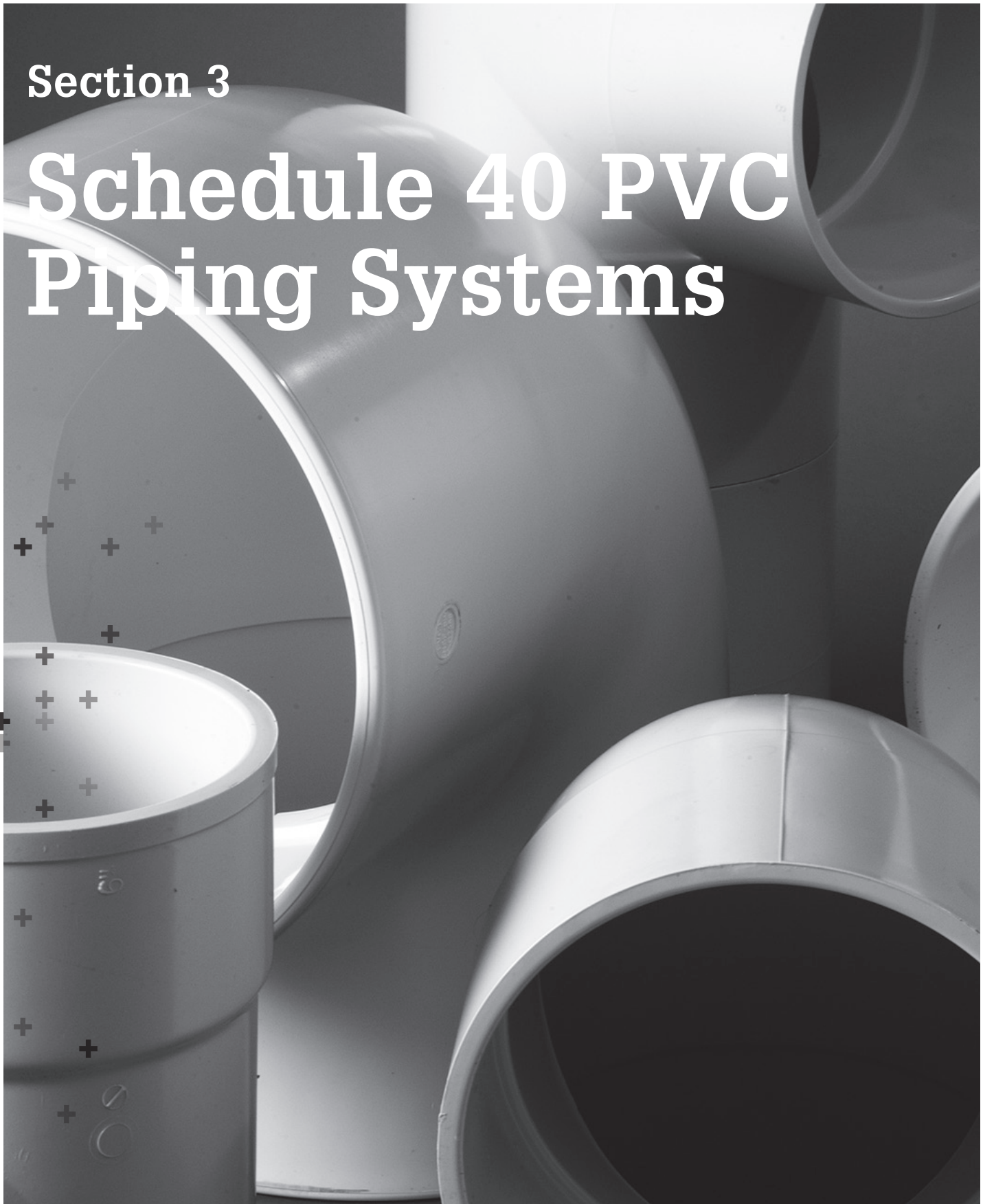

## Glossary

<b>FPT</b>	=	<b>Female Pipe Thread</b>
<b>MPT</b>	=	<b>Male Pipe Thread</b>
<b>S</b>	=	<b>Tapered Socket</b>
<b>SPG</b>	=	<b>Spigot End (same dimension as pipe outside diameter)</b>
<b>*</b>	=	<b>Non-Returnable / Non-cancellable</b>
<b>^</b>	=	<b>40% Restocking Fee</b>
<b>BUSH</b>	=	<b>Assembled Fitting from Molded Components</b>
<b>FAB</b>	=	<b>Fabricated Fitting</b>

The technical information given in this publication implies no warranty of any kind and is subject to change without notice. Please consult our Terms and Conditions of Sale.

For complete technical information, please consult the Vinyl Catalog and Technical Information

**For more information about any of our product lines, please visit [www.gfps.com](http://www.gfps.com)**

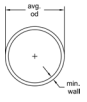

**Table of contents****Page**

Harvel® Industrial Schedule 40 PVC Pressure Pipe - White

179

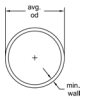

Harvel® Industrial PLUS Schedule 40 PVC Pressure Pipe - White

180

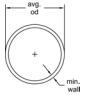

Harvel® Schedule 40 PVC Pressure Pipe - Gray

181



Schedule 40 PVC Pressure Fittings

182

# Specifications and Standards

## Specifications and Standards

NSF/ANSI Standard 14

NSF/ANSI Standard 61

ASTM D 1784 : Material PVC Type I, Grade I White or Gray (cell classification 12454)

ASTM D 1785 : PVC Schedule 40 Pipe

ASTM D 2665 : PVC Schedule 40 Drain, Waste, and Vent (DWV)

ASTM D 2466 : PVC Schedule 40 Socket and Threaded Fittings

ASTM F 1498 : PVC Schedule 40 Taper Threads

ASTM D 2672 : PVC Schedule 40 Tapered Sockets for Bell End Pipe

ANSI B1.20.1 : PVC Schedule 40 NPT Threads

P0800892

# Harvel® Industrial Schedule 40 PVC Pressure Pipe - White

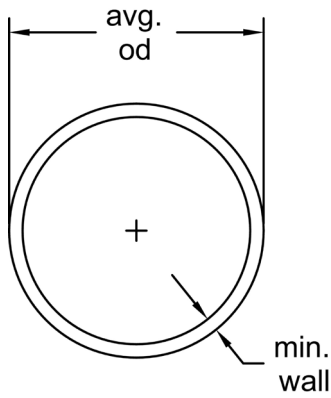

## Plain End Pipe - 20 ft lengths

- Refer to Industrial PLUS for sizes 3-1/2", 5", 14"-24"
- Max Water Pressure at 73°F (22.7°C) with solvent-cemented joints
- Meets NSF<sup>®</sup>-pw-G
- Non - CSA Approved

Size (inch)	P/L	Plain End Part No.	Lift Qty (ft)	Average O.D. (inch)	Min. Wall (inch)	Wt/Ft (lbs/ft)	Max Water Pressure (psi)
½	H17	<b>H0400050PW2000</b>	5700	0.840	0.109	0.161	600
¾	H17	<b>H0400075PW2000</b>	5260	1.050	0.113	0.214	480
1	H17	<b>H0400100PW2000</b>	4280	1.315	0.133	0.315	450
1 ¼	H17	<b>H0400125PW2000</b>	2360	1.660	0.140	0.426	370
1 ½	H17	<b>H0400150PW2000</b>	2060	1.900	0.145	0.509	330
2	H17	<b>H0400200PW2000</b>	1660	2.375	0.154	0.682	280
2 ½	H17	<b>H0400250PW2000</b>	1080	2.875	0.203	1.076	300
3	H17	<b>H0400300PW2000</b>	840	3.500	0.216	1.409	260
4	H17	<b>H0400400PW2000</b>	520	4.500	0.237	2.006	220
6	H17	<b>H0400600PW2000</b>	340	6.625	0.280	3.535	180
8	H17	<b>H0400800PW2000</b>	220	8.625	0.322	5.305	160
10	H17	<b>H0401000PW2000</b>	80	10.750	10.750	7.532	140
12	H17	<b>H0401200PW2000</b>	60	12.750	12.750	9.949	130

## Belled End Pipe - 20 ft length Less Bell

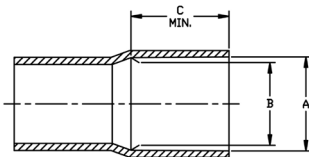

Size (inch)	P/L	Belled End Part No.	A-Socket Entrance (Belled Pipe)	B-Socket Bottom (Belled Pipe)	C-Min. (Belled Pipe)
½	H17	<b>H0400050PW200B</b>	0.848±0.004	0.836±0.004	1.000
¾	H17	<b>H0400075PW200B</b>	1.058±0.004	1.046±0.004	1.250
1	H17	<b>H0400100PW200B</b>	1.325±0.005	1.310±0.005	1.500
1 ¼	H17	<b>H0400125PW200B</b>	1.670±0.005	1.655±0.005	1.750
1 ½	H17	<b>H0400150PW200B</b>	1.912±0.006	1.894±0.006	2.000
2	H17	<b>H0400200PW200B</b>	2.387±0.006	2.363±0.006	2.250
2 ½	H17	<b>H0400250PW200B</b>	2.889±0.007	2.861±0.007	2.500
3	H17	<b>H0400300PW200B</b>	3.516±0.008	3.484±0.008	3.250
4	H17	<b>H0400400PW200B</b>	4.518±0.009	4.482±0.009	4.000
6	H17	<b>H0400600PW200B</b>	6.647±0.011	6.603±0.011	6.000
8	H17	<b>H0400800PW200B</b>	8.655±0.015	8.598±0.015	6.000
10	H17	<b>H0401000PW200B</b>	10.776±0.015	10.722±0.015	7.500
12	H17	<b>H0401200PW200B</b>	12.778±0.015	12.721±0.015	8.500

# Harvel® Industrial PLUS Schedule 40 PVC Pressure Pipe - White

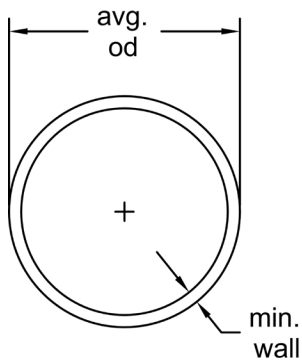

## Plain End Pipe - 20 ft lengths

- Max Water Pressure at 73°F (22.7°C) with solvent-cemented joints
- Meets NSF<sup>®</sup>-pw-G
- Meets CAN/CSA B137.3 Requirements

Size (inch)	P/L	Plain End Part No.	Lift Qty (ft)	Average O.D. (inch)	Min. Wall (inch)	Wt/Ft (lbs/ft)	Max Water Pressure (psi)
½	H51	HX400050PW2000	5700	0.840	0.109	0.161	600
¾	H51	HX400075PW2000	5260	1.050	0.113	0.214	480
1	H51	HX400100PW2000	4280	1.315	0.133	0.315	450
1 ¼	H51	HX400125PW2000	2360	1.660	0.140	0.426	370
1 ½	H51	HX400150PW2000	2060	1.900	0.145	0.509	330
2	H51	HX400200PW2000	1660	2.375	0.154	0.682	280
2 ½	H51	HX400250PW2000	1080	2.875	0.203	1.076	300
3	H51	HX400300PW2000	840	3.500	0.216	1.409	260
3 ½	H51	H0400350PW2000	680	4.000	0.226	1.697	240
4	H51	HX400400PW2000	520	4.500	0.237	2.006	220
5	H51	H0400500PW2000	400	5.563	0.258	2.726	190
6	H51	HX400600PW2000	340	6.625	0.280	3.535	180
8	H51	HX400800PW2000	220	8.625	0.322	5.305	160
10	H51	HX401000PW2000	80	10.750	0.365	7.532	140
12	H51	HX401200PW2000	60	12.750	0.406	9.949	130
14	H51	H0401400PW2000	60	14.000	0.437	11.810	130
16	H51	H0401600PW2000	60	16.000	0.500	15.416	130
18	H51	H0401800PW2000	60	18.000	0.562	20.112	130
20	H51	H0402000PW2000	40	20.000	0.593	23.624	120
24	H51	H0402400PW2000	40	24.000	0.687	32.873	120

## Belled End Pipe - 20 ft length Less Bell

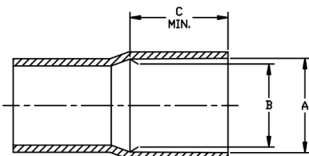

Size (inch)	P/L	Belled End Part No.	A-Socket Entrance (Belled Pipe)	B-Socket Bottom (Belled Pipe)	C-Min. (Belled Pipe)
½	H51	HX400050PW200B	0.848±0.004	0.836±0.004	1.000
¾	H51	HX400075PW200B	1.058±0.004	1.046±0.004	1.250
1	H51	HX400100PW200B	1.325±0.005	1.310±0.005	1.500
1 ¼	H51	HX400125PW200B	1.670±0.005	1.655±0.005	1.750
1 ½	H51	HX400150PW200B	1.912±0.006	1.894±0.006	2.000
2	H51	HX400200PW200B	2.387±0.006	2.363±0.006	2.250
2 ½	H51	HX400250PW200B	2.889±0.007	2.861±0.007	2.500
3	H51	HX400300PW200B	3.516±0.008	3.484±0.008	3.250
3 ½	H51	H0400350PW200B	4.016±0.008	3.984±0.008	3.500
4	H51	HX400400PW200B	4.518±0.009	4.482±0.009	4.000
5	H51	H0400500PW200B	5.583±0.010	5.543±0.010	4.000
6	H51	HX400600PW200B	6.647±0.011	6.603±0.011	6.000
8	H51	HX400800PW200B	8.655±0.015	8.598±0.015	6.000
10	H51	HX401000PW200B	10.776±0.015	10.722±0.015	7.500
12	H51	HX401200PW200B	12.778±0.015	12.721±0.015	8.500
14	H51	H0401400PW200B	14.035±0.015	13.985±0.015	9.000
16	H51	H0401600PW200B	16.045±0.015	15.980±0.015	10.000
18	H51	H0401800PW200B	18.055±0.020	17.980±0.020	12.000
20	H51	H0402000PW200B	20.065±0.025	19.980±0.025	12.000
24	H51	H0402400PW200B	24.075±0.030	23.970±0.030	12.000

# Harvel® Schedule 40 PVC Pressure Pipe - Gray

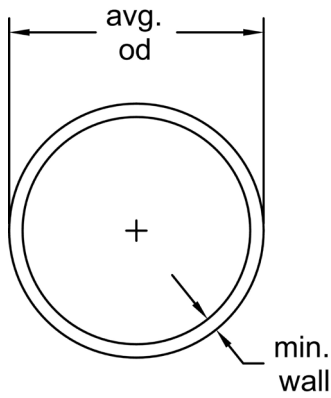

## Plain End Pipe - 20 ft lengths

- Max Water Pressure at 73°F (22.7°C) with solvent-cemented joints
- Meets NSF®-pw-G
- Non - CSA Approved

Size (inch)	P/L	Plain End Part No.	Lift Qty (ft)	Average O.D. (inch)	min. wall (inch)	Wt/Ft (lbs/ft)	Max Water Pressure (psi)
½	H16	H0400013PG2000	5700	0.405	0.068	0.045	810
¾	H16	H0400025PG2000	5700	0.540	0.088	0.081	780
¾	H16	H0400038PG2000	5700	0.675	0.091	0.109	620
½	H16	H0400050PG2000	5700	0.840	0.109	0.161	600
¾	H16	H0400075PG2000	5260	1.050	0.113	0.214	480
1	H16	H0400100PG2000	4280	1.315	0.133	0.315	450
1 ¼	H16	H0400125PG2000	2360	1.660	0.140	0.426	370
1 ½	H16	H0400150PG2000	2060	1.900	0.145	0.509	330
2	H16	H0400200PG2000	1660	2.375	0.154	0.682	280
2 ½	H16	H0400250PG2000	1080	2.875	0.203	1.076	300
3	H16	H0400300PG2000	840	3.500	0.216	1.409	260
3 ½	H16	H0400350PG2000	680	4.000	0.226	1.697	240
4	H16	H0400400PG2000	520	4.500	0.237	2.006	220
5	H16	H0400500PG2000	400	5.563	0.258	2.726	190
6	H16	H0400600PG2000	340	6.625	0.280	3.535	180
8	H16	H0400800PG2000	220	8.625	0.332	5.305	160
10	H16	H0401000PG2000	80	10.750	0.365	7.532	140
12	H16	H0401200PG2000	60	12.750	0.406	9.949	130
14	H16	H0401400PG2000	60	14.000	0.437	11.810	130
16	H16	H0401600PG2000	60	16.000	0.500	15.416	130
18	H16	H0401800PG2000	40	18.000	0.562	20.112	130
20	H16	H0402000PG2000	40	20.000	0.593	23.624	120
24	H16	H0402400PG2000	40	24.000	0.687	32.873	120

## Belled End Pipe - 20 ft length Less Bell

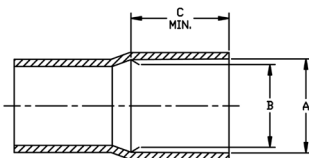

Size (inch)	P/L	Belled End Part No.	A-Socket Entrance (Belled Pipe)	B-Socket Bottom (Belled Pipe)	C-Min. (Belled Pipe)
½	H16	H0400050PG200B	0.848±0.004	0.836±0.004	1.000
¾	H16	H0400075PG200B	1.058±0.004	1.046±0.004	1.250
1	H16	H0400100PG200B	1.325±0.005	1.310±0.005	1.500
1 ¼	H16	H0400125PG200B	1.670±0.005	1.655±0.005	1.750
1 ½	H16	H0400150PG200B	1.912±0.005	1.894±0.006	2.000
2	H16	H0400200PG200B	2.387±0.006	2.363±0.006	2.250
2 ½	H16	H0400250PG200B	2.889±0.007	2.861±0.007	2.500
3	H16	H0400300PG200B	3.516±0.008	3.484±0.008	3.250
3 ½	H16	H0400350PG200B	4.016±0.008	3.984±0.008	3.500
4	H16	H0400400PG200B	4.518±0.009	4.482±0.009	4.000
5	H16	H0400500PG200B	5.583±0.010	5.543±0.010	4.000
6	H16	H0400600PG200B	6.647±0.011	6.603±0.011	6.000
8	H16	H0400800PG200B	8.655±0.015	8.598±0.015	6.000
10	H16	H0401000PG200B	10.776±0.015	10.722±0.015	7.500
12	H16	H0401200PG200B	12.778±0.015	12.721±0.015	8.500
14	H16	H0401400PG200B	14.035±0.015	13.985±0.015	9.000
16	H16	H0401600PG200B	16.045±0.015	15.980±0.015	10.000
18	H16	H0401800PG200B	18.055±0.020	17.980±0.020	12.000
20	H16	H0402000PG200B	20.065±0.025	19.980±0.025	12.000
24	H16	H0402400PG200B	24.075±0.030	23.970±0.030	12.000

# Schedule 40 PVC Pressure Fittings

## Tee (S x S x S)

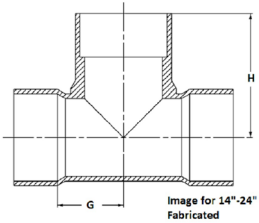
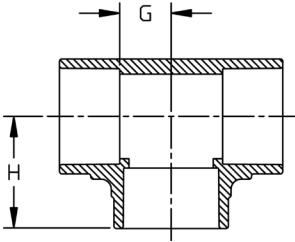

Size (inch)	P/L	Part No.	Pack Qty	H (inch)	G (inch)	Design
½	601	401-005	50	1.25	0.38	
¾	601	401-007	50	1.38	0.56	
1	601	401-010	50	1.69	0.69	
1 ¼	601	401-012	25	2.13	0.88	
1 ½	601	401-015	25	2.31	1.00	
2	601	401-020	25	2.63	1.25	
2 ½	601	401-025	10	3.50	1.50	
3	601	401-030	10	3.81	1.81	
4	601	401-040	5	4.31	2.31	
6	601	401-060	4	7.06	3.50	
8	601	401-080	2	9.00	4.50	
10	B09	401-100	1	10.94	5.88	
12	B09	401-120	1	13.06	7.00	
14	A32	401-140N	1	19.38	10.06	FAB
16	A32	401-160N	1	21.63	11.75	FAB
18	A32	401-180N	1	24.50	12.88	FAB
20	A32	401-200N	1	26.25	14.31	FAB
24	A32	401-240N	1	33.13	16.75	FAB

## Reducing Tee (S x S x S)

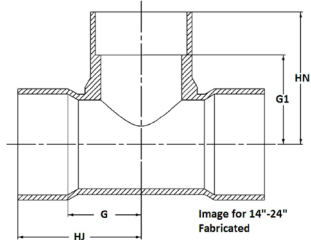
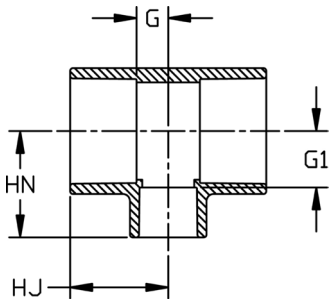

Size (inch)	P/L	Part No.	Pack Qty	HJ (inch)	HN (inch)	G (inch)	G1 (inch)	Design
¾ x ½ x ½	601	401-094	50	1.31	1.31	0.50	0.56	
¾ x ½ x ¾	601	401-095	50	1.31	1.31	0.56	0.56	
¾ x ¾ x ½	601	401-101	50	1.31	1.38	0.50	0.63	
¾ x ¾ x 1	601	401-102	50	1.50	1.56	0.69	0.56	
1 x ½ x 1	601	401-122	50	1.69	1.69	0.69	0.75	
1 x ¾ x ¾	601	401-125	50	1.56	1.44	0.53	0.69	
1 x ¾ x 1	601	401-126	50	1.69	1.69	0.75	0.69	
1 x 1 x ½	601	401-130	50	1.50	1.50	0.50	0.69	
1 x 1 x ¾	601	401-131	50	1.56	1.50	0.56	0.69	
1 x 1 x 1 ¼	601	401-132	50	1.88	1.94	0.88	0.69	
1 x 1 x 1 ½	601	401-133	25	2.00	2.00	1.00	0.69	
1 ¼ x 1 x ¾	601	401-157	25	2.06	1.63	0.88	0.88	
1 ¼ x 1 x 1	601	401-158	25	2.06	2.00	0.88	0.88	
1 ¼ x 1 ¼ x ½	601	401-166	25	1.75	1.63	1.25	0.88	
1 ¼ x 1 ¼ x ¾	601	401-167	25	1.88	1.69	0.56	0.88	
1 ¼ x 1 ¼ x 1	601	401-168	25	1.94	1.88	0.69	0.88	
1 ½ x 1 ½ x ½	601	401-209	25	1.81	1.81	0.50	1.00	
1 ½ x 1 ½ x ¾	601	401-210	25	1.94	1.81	0.63	1.00	
1 ½ x 1 ½ x 1	601	401-211	25	2.00	2.00	0.69	1.00	
1 ½ x 1 ½ x 1 ¼	601	401-212	25	2.19	2.25	0.88	1.06	
2 x 1 ½ x ¾	601	401-238	10	2.00	2.06	0.56	1.25	
2 x 1 ½ x 1	601	401-239	10	2.63	2.25	1.25	1.19	
2 x 2 x ½	601	401-247	10	1.88	2.00	0.50	1.25	
2 x 2 x ¾	601	401-248	10	2.00	2.00	0.56	1.25	
2 x 2 x 1	601	401-249	10	2.06	2.25	0.69	1.25	
2 x 2 x 1 ¼	601	401-250	10	2.25	2.50	0.88	1.25	
2 x 2 x 1 ½	601	401-251	10	2.38	2.56	1.00	1.25	
2 ½ x 2 ½ x ¾	601	401-288	10	2.44	2.31	0.56	1.50	

table continued on the next page



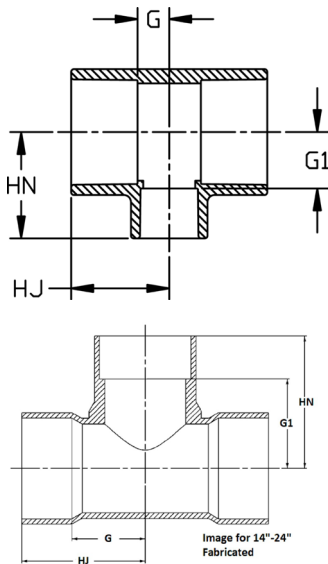

Size (inch)	P/L	Part No.	Pack Qty	HJ (inch)	HN (inch)	G (inch)	G1 (inch)	Design
2 1/2 x 2 1/2 x 1	601	401-289	10	2.56	2.63	0.69	1.50	
2 1/2 x 2 1/2 x 1 1/4	601	401-290	10	2.88	2.75	0.88	1.50	
2 1/2 x 2 1/2 x 1 1/2	601	401-291	10	3.13	2.75	1.00	1.50	
2 1/2 x 2 1/2 x 2	601	401-292	10	3.13	2.88	1.25	1.50	
3 x 3 x 3/4	601	401-334	10	2.56	2.56	0.56	1.81	
3 x 3 x 1	601	401-335	10	2.69	2.88	0.69	1.81	
3 x 3 x 1 1/4	601	401-336	10	2.88	3.06	0.88	1.81	
3 x 3 x 1 1/2	601	401-337	10	3.00	3.19	1.00	1.81	
3 x 3 x 2	601	401-338	10	3.25	3.19	1.25	1.81	
4 x 4 x 3/4	601	401-416	4	2.56	3.00	0.56	2.31	
4 x 4 x 1	601	401-417	4	2.75	3.31	0.69	2.31	
4 x 4 x 1 1/4	601	401-418	5	2.88	3.56	0.88	2.31	
4 x 4 x 2	601	401-420	5	3.25	3.69	1.25	2.31	
4 x 4 x 1 1/2	601	401-419	5	3.00	3.63	1.00	2.31	
4 x 4 x 3	601	401-422	5	3.81	4.38	1.81	2.31	
6 x 6 x 2	601	401-528	5	4.75	4.94	1.25	3.50	
6 x 6 x 3	601	401-530	5	5.38	5.56	1.81	3.50	
6 x 6 x 4	601	401-532	5	5.88	5.56	2.38	3.50	
8 x 8 x 4	601	401-582	2	6.81	6.94	2.31	4.88	
8 x 8 x 6	601	401-585	2	8.00	8.06	3.50	4.50	
10 x 10 x 4	B09	401-624	1	10.50	7.94	5.44	5.94	
10 x 10 x 6	B09	401-626	1	10.50	8.94	5.44	5.94	
10 x 10 x 8	B09	401-628	1	10.50	9.88	5.44	5.88	
12 x 12 x 4	B09	401-664	1	11.50	9.00	5.44	6.94	
12 x 12 x 6	B09	401-666	1	11.50	10.00	5.44	6.94	
12 x 12 x 8	B09	401-668	1	11.50	11.00	5.44	7.00	
12 x 12 x 10	B09	401-670	1	13.06	13.50	7.00	8.44	
14 x 14 x 4	A32	401-696N	1	12.18	12.00	5.18	10.00	FAB
14 x 14 x 6	A32	401-698N	1	13.12	13.63	6.12	10.63	FAB
14 x 14 x 8	A32	401-700N	1	14.25	15.25	7.25	11.75	FAB
14 x 14 x 10	A32	401-702N	1	15.31	16.75	8.31	11.75	FAB
14 x 14 x 12	A32	401-704N	1	16.00	18.00	9.00	12.00	FAB
16 x 16 x 4	A32	401-730N	1	14.00	13.38	6.00	11.38	FAB
16 x 16 x 6	A32	401-732N	1	15.00	14.50	7.00	11.50	FAB
16 x 16 x 8	A32	401-734N	1	16.00	16.25	8.00	12.25	FAB
16 x 16 x 10	A32	401-736N	1	16.50	17.75	8.50	12.75	FAB
16 x 16 x 12	A32	401-738N	1	19.25	19.50	9.63	13.50	FAB
16 x 16 x 14	A32	401-740N	1	19.18	20.50	11.18	13.50	FAB
18 x 18 x 6	A32	401-786N	1	15.63	15.75	6.63	12.75	FAB
18 x 18 x 8	A32	401-788N	1	16.63	17.00	7.63	13.00	FAB
18 x 18 x 10	A32	401-790N	1	17.75	18.38	8.75	13.38	FAB
18 x 18 x 12	A32	401-792N	1	18.75	20.50	9.75	14.50	FAB
18 x 18 x 14	A32	401-794N	1	19.56	21.38	10.56	14.38	FAB
18 x 18 x 16	A32	401-796N	1	20.63	22.50	11.63	14.50	FAB
20 x 20 x 8	A32	401-818N	1	18.94	18.13	8.94	14.13	FAB
20 x 20 x 10	A32	401-820N	1	19.69	19.75	9.69	14.75	FAB
20 x 20 x 12	A32	401-822N	1	21.00	21.13	11.00	15.13	FAB
20 x 20 x 14	A32	401-824N	1	21.63	22.75	11.63	15.75	FAB
20 x 20 x 16	A32	401-826N	1	23.00	24.50	13.00	16.50	FAB
20 x 20 x 18	A32	401-828N	1	23.81	24.50	13.81	15.50	FAB
24 x 24 x 6	A32	401-906N	1	27.75	18.50	7.88	15.50	FAB
24 x 24 x 8	A32	401-908N	1	20.69	20.50	8.69	16.50	FAB
24 x 24 x 10	A32	401-910N	1	21.88	21.63	9.88	16.63	FAB
24 x 24 x 12	A32	401-912N	1	23.00	23.00	11.00	17.00	FAB
24 x 24 x 14	A32	401-914N	1	23.88	25.00	11.88	18.00	FAB
24 x 24 x 16	A32	401-916N	1	24.94	26.31	12.94	18.31	FAB
24 x 24 x 18	A32	401-918N	1	25.88	27.75	13.88	18.75	FAB
24 x 24 x 20	A32	401-920N	1	26.94	30.00	14.94	20.00	FAB

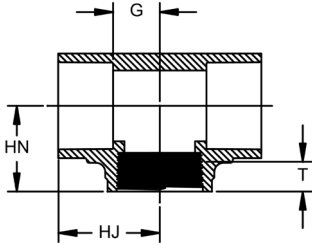

### Tee (S x S X FPT)

Size (inch)	P/L	Part No.	Pack Qty	HJ (inch)	HN (inch)	G (inch)	T (inch)
½	601	<b>402-005</b>	50	1.25	1.25	0.50	0.75
¾	601	<b>402-007</b>	50	1.38	1.38	0.56	0.81
1	601	<b>402-010</b>	50	1.69	1.69	0.69	1.00
1 ¼	601	<b>402-012</b>	25	2.13	2.13	0.88	0.94
1 ½	601	<b>402-015</b>	25	2.31	2.31	1.00	0.88
2	601	<b>402-020</b>	10	2.63	2.19	1.25	0.94
3	601	<b>402-030</b>	10	3.81	3.19	1.81	1.44
4	601	<b>402-040</b>	5	4.31	4.00	2.31	1.69

### Reducing Tee (S x S x FPT)

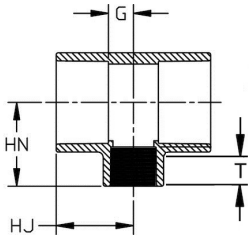

Size (inch)	P/L	Part No.	Pack Qty	HJ (inch)	HN (inch)	G (inch)	T (inch)
¾ x ¾ x ½	601	<b>402-101</b>	50	1.31	1.31	0.50	0.75
1 x 1 x ½	601	<b>402-130</b>	50	1.50	1.43	0.50	0.69
1 x 1 x ¾	601	<b>402-131</b>	50	1.56	1.50	0.56	0.75
1 ¼ x 1 ¼ x ¾	601	<b>402-167</b>	25	1.81	1.63	0.56	0.69
1 ¼ x 1 ¼ x 1	601	<b>402-168</b>	25	1.94	1.88	0.69	0.88
1 ½ x 1 ½ x ½	601	<b>402-209</b>	25	1.81	1.75	0.50	0.75
1 ½ x 1 ½ x ¾	601	<b>402-210</b>	25	1.88	1.81	0.56	0.69
1 ½ x 1 ½ x 1	601	<b>402-211</b>	25	2.00	2.00	0.69	1.00
1 ½ x 1 ½ x 1 ¼	601	<b>402-212</b>	25	2.19	2.25	0.88	1.25
2 x 2 x ½	601	<b>402-247</b>	10	1.88	2.00	0.50	0.75
2 x 2 x ¾	601	<b>402-248</b>	10	2.00	2.06	0.56	0.81
2 x 2 x 1	601	<b>402-249</b>	10	2.06	2.25	0.69	1.00
2 x 2 x 1 ¼	601	<b>402-250</b>	10	2.25	2.50	0.88	0.94
2 x 2 x 1 ½	601	<b>402-251</b>	10	2.38	2.56	1.00	0.94
2 ½ x 2 ½ x 1 ½	601	<b>402-291</b>	10	3.00	2.50	1.00	1.00
2 ½ x 2 ½ x 2	601	<b>402-292</b>	10	3.25	2.88	1.25	1.06
3 x 3 x 1 ½	601	<b>402-337</b>	10	6.00	2.81	1.00	0.94
3 x 3 x 2	601	<b>402-338</b>	10	6.56	2.88	1.25	1.06
4 x 4 x 1 ½	601	<b>402-419</b>	5	6.06	3.69	1.00	1.38
4 x 4 x 2	601	<b>402-420</b>	5	6.50	3.38	1.25	1.13
4 x 4 x 3	601	<b>402-422</b>	5	7.63	4.63	1.81	1.63
6 x 6 x 3	601	<b>402-530</b>	5	10.69	5.50	2.31	2.00
6 x 6 x 4	601	<b>402-532</b>	5	11.69	5.50	2.31	2.00

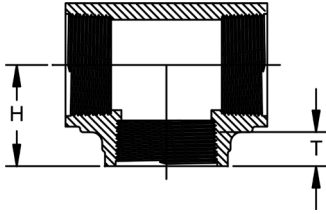

### Tee (FPT x FPT x FPT)

Size (inch)	P/L	Part No.	Pack Qty	H (inch)	T (inch)
½	601	<b>405-005</b>	50	1.25	0.72
¾	601	<b>405-007</b>	50	1.38	0.81
1	601	<b>405-010</b>	50	1.69	1.00
1 ¼	601	<b>405-012</b>	25	2.13	0.88
1 ½	601	<b>405-015</b>	25	2.31	1.31

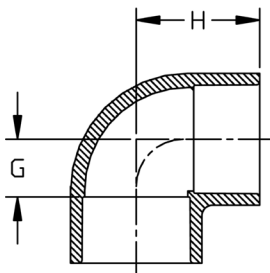

### 90° Ell (S x S)

Size (inch)	P/L	Part No.	Pack Qty	H (inch)	G (inch)	Design
½	601	<b>406-005</b>	50	1.25	0.50	
¾	601	<b>406-007</b>	50	1.38	0.56	
1	601	<b>406-010</b>	50	1.69	0.69	
1 ¼	601	<b>406-012</b>	25	2.13	0.88	
1 ½	601	<b>406-015</b>	25	2.25	1.00	
2	601	<b>406-020</b>	25	2.56	1.25	
2 ½	601	<b>406-025</b>	10	3.50	1.50	
3	601	<b>406-030</b>	10	3.81	1.81	
4	601	<b>406-040</b>	5	4.38	2.31	
6	601	<b>406-060</b>	4	7.00	3.50	
8	601	<b>406-080</b>	3	9.00	4.50	
10	B09	<b>406-100</b>	1	11.19	6.19	
12	B09	<b>406-120</b>	1	13.25	7.19	
14	A32	<b>406-140N</b>	1	23.88	16.88	FAB
16	A32	<b>406-160N</b>	1	26.50	18.50	FAB
18	A32	<b>406-180N</b>	1	30.38	21.38	FAB
20	A32	<b>406-200N</b>	1	34.00	24.00	FAB
24	A32	<b>406-240N</b>	1	39.63	27.63	FAB

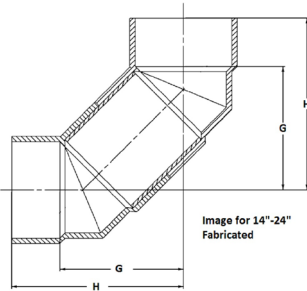



### Reducing 90° Ell (S x S)

Size (inch)	P/L	Part No.	Pack Qty	HJ (inch)	HN (inch)	G (inch)	G1 (inch)
¾ x ½	601	<b>406-101</b>	50	1.31	1.31	0.50	0.56
1 x ½	601	<b>406-130</b>	50	1.50	1.38	0.50	0.69
1 x ¾	601	<b>406-131</b>	50	1.56	1.50	0.56	0.69

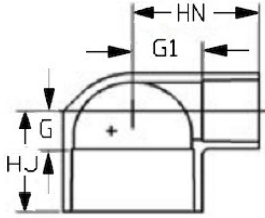

### 90° Ell (S x FPT)

Size (inch)	P/L	Part No.	Pack Qty	HJ (inch)	HN (inch)	G (inch)	T (inch)
½	601	<b>407-005</b>	50	1.25	1.19	0.50	0.75
¾	601	<b>407-007</b>	50	1.38	1.38	0.63	0.81
1	601	<b>407-010</b>	50	1.63	1.69	0.69	1.00
1 ¼	601	<b>407-012</b>	25	2.19	1.81	0.88	0.88
1 ½	601	<b>407-015</b>	25	2.31	2.31	1.00	1.31
2	601	<b>407-020</b>	10	2.63	2.63	1.25	1.38
2 ½	601	<b>407-025</b>	10	3.38	2.75	1.50	1.25
3	601	<b>407-030</b>	10	3.75	3.19	1.75	1.56
4	601	<b>407-040</b>	5	4.38	4.19	2.38	0.88

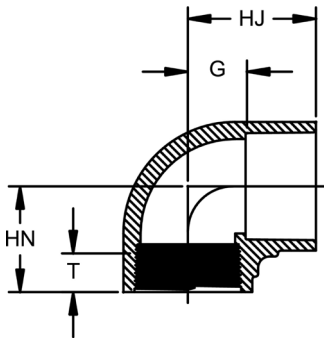

### Reducing 90° Ell (S x FPT)

Size (inch)	P/L	Part No.	Pack Qty	HJ (inch)	HN (inch)	G (inch)	T (inch)
¾ x ½	601	<b>407-101</b>	50	1.38	1.25	0.56	0.68
1 x ½	601	<b>407-130</b>	50	1.56	1.38	0.56	0.69
1 x ¾	601	<b>407-131</b>	50	1.56	1.50	0.56	0.81
1 ¼ x 1	601	<b>407-168</b>	25	1.94	1.88	0.69	1.00
1 ½ x 1	601	<b>407-211</b>	25	1.94	2.75	1.06	1.00
1 ½ x 1 ¼	601	<b>407-212</b>	25	2.19	2.25	0.88	0.94
2 x 1	601	<b>407-249</b>	25	2.19	2.44	0.81	0.88
2 x 1 ¼	601	<b>407-250</b>	10	2.25	2.44	0.88	0.88
2 x 1 ½	601	<b>407-251</b>	10	2.44	2.63	1.06	0.94

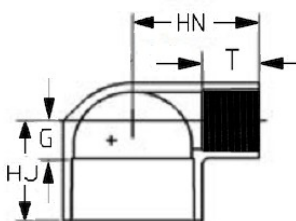



### 90° Ell (FPT x FPT)

Size (inch)	P/L	Part No.	Pack Qty	H (inch)	T (inch)
½	601	<b>408-005</b>	50	1.31	0.81
¾	601	<b>408-007</b>	50	1.38	0.81
1	601	<b>408-010</b>	50	1.69	1.00
1 ¼	601	<b>408-012</b>	25	2.13	1.19
1 ½	601	<b>408-015</b>	25	2.31	1.38
2	601	<b>408-020</b>	10	2.63	1.38

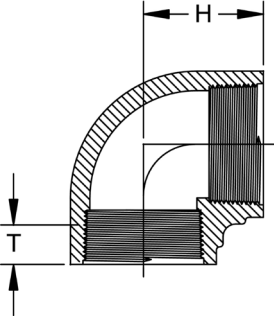

### 90° Street Ell (S x SPG)

Size (inch)	P/L	Part No.	Pack Qty	HJ (inch)	HN (inch)	G (inch)	T (inch)
½	601	<b>409-005</b>	50	1.31	1.13	0.56	0.81
¾	601	<b>409-007</b>	50	1.63	1.25	0.81	0.75
1	601	<b>409-010</b>	50	1.88	1.44	0.88	0.88
1 ¼	601	<b>409-012</b>	25	2.38	2.13	1.06	1.31
1 ½	601	<b>409-015</b>	25	2.63	2.31	1.25	1.31
2	601	<b>409-020</b>	10	2.88	2.63	1.44	1.38
2 ½	601	<b>409-025</b>	10	4.06	3.38	2.00	1.94
3	601	<b>409-030</b>	10	4.44	4.19	2.31	2.00

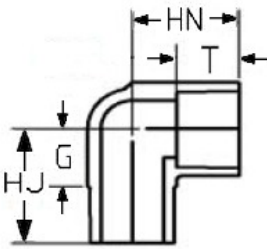

### 90° Street Ell (S x MPT)

Size (inch)	P/L	Part No.	Pack Qty	HJ (inch)	HN (inch)	G (inch)	T (inch)
½	601	<b>410-005</b>	50	1.25	1.31	0.69	0.63
¾	601	<b>410-007</b>	50	1.25	1.56	0.75	0.81
1	601	<b>410-010</b>	50	1.56	1.88	1.00	0.88
1 ¼	601	<b>410-012</b>	25	2.06	1.94	1.13	0.81
1 ½	601	<b>410-015</b>	25	2.31	2.31	1.25	1.06
2	601	<b>410-020</b>	10	2.69	2.25	1.50	0.75

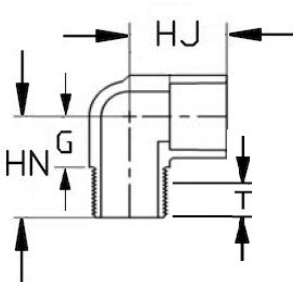



### 90° Street Ell (FPT x MPT)

Size (inch)	P/L	Part No.	Pack Qty	HJ (inch)	HN (inch)	G (inch)	T (inch)
½	601	<b>412-005</b>	50	1.44	1.06	0.81	0.31
¾	601	<b>412-007</b>	50	1.63	1.19	0.81	0.44
1	601	<b>412-010</b>	50	1.88	1.44	0.88	0.56
1 ¼	601	<b>412-012</b>	25	1.94	2.13	1.13	1.19
1 ½	601	<b>412-015</b>	25	2.31	2.31	1.25	1.31
2	601	<b>412-020</b>	10	2.75	2.31	1.56	1.06

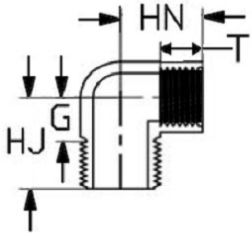

### Side Outlet Elbow (S x S x S)

Size (inch)	P/L	Part No.	Pack Qty	H (inch)	G (inch)
½	601	<b>413-005</b>	50	1.31	0.56
¾	601	<b>413-007</b>	50	1.38	0.56
1	601	<b>413-010</b>	25	1.69	0.69
1 ½	601	<b>413-015</b>	25	2.44	1.00
2	601	<b>413-020</b>	10	2.63	1.25

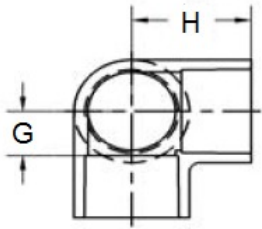



### 45° Ell (S x S)

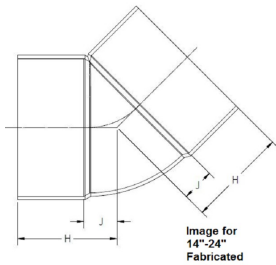
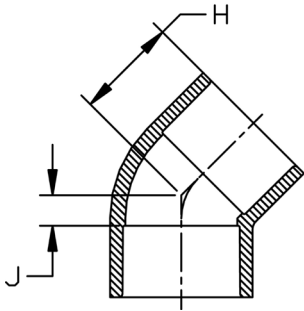

Size (inch)	P/L	Part No.	Pack Qty	H (inch)	J (inch)	Design
½	601	<b>417-005</b>	50	1.06	0.25	
¾	601	<b>417-007</b>	50	1.19	0.38	
1	601	<b>417-010</b>	50	1.44	0.31	
1 ¼	601	<b>417-012</b>	25	1.63	0.38	
1 ½	601	<b>417-015</b>	25	1.69	0.44	
2	601	<b>417-020</b>	25	2.00	0.69	
2 ½	601	<b>417-025</b>	10	2.69	0.69	
3	601	<b>417-030</b>	10	2.75	0.75	
4	601	<b>417-040</b>	5	3.00	1.00	
6	601	<b>417-060</b>	4	5.38	1.81	
8	601	<b>417-080</b>	4	6.50	2.00	
10	B09	<b>417-100</b>	1	8.06	3.06	
12	B09	<b>417-120</b>	1	9.56	3.50	
14	A32	<b>417-140N</b>	1	10.00	3.00	FAB
16	A32	<b>417-160N</b>	1	11.63	3.63	FAB
18	A32	<b>417-180N</b>	1	13.13	4.13	FAB
20	A32	<b>417-200N</b>	1	14.50	4.50	FAB
24	A32	<b>417-240N</b>	1	16.75	4.75	FAB

### Cross (S x S x S x S)

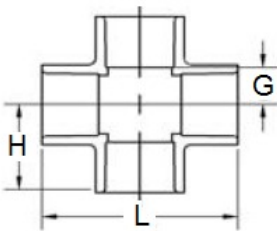

Size (inch)	P/L	Part No.	Pack Qty	L (inch)	H (inch)	G (inch)
½	601	<b>420-005</b>	50	2.44	1.19	0.50
¾	601	<b>420-007</b>	50	2.63	1.31	0.56
1	601	<b>420-010</b>	50	3.38	1.69	0.69
1 ¼	601	<b>420-012</b>	25	4.25	2.13	0.88
1 ½	601	<b>420-015</b>	25	4.63	2.31	1.00
2	601	<b>420-020</b>	10	5.25	2.63	1.25
2 ½	601	<b>420-025</b>	8	7.00	3.50	1.50
3	601	<b>420-030</b>	10	7.63	3.81	1.81
4	601	<b>420-040</b>	5	8.69	4.31	2.31



### Reducing Cross (S x S x S x S)

Size (inch)	P/L	Part No.	Pack Qty	H (inch)	H1 (inch)	G (inch)	G1 (inch)
3 x 1 1/2	601	<b>420-337</b>	10	3.00	3.13	1.00	1.81
3 x 2	601	<b>420-338</b>	10	3.25	3.19	1.25	1.81
4 x 1 1/2	601	<b>420-419</b>	5	3.00	3.63	1.00	2.31
4 x 2	601	<b>420-420</b>	5	3.25	3.69	1.25	2.31

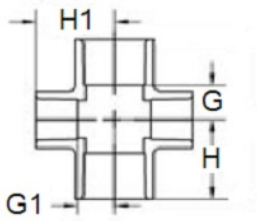

### Coupling (S x S)

Size (inch)	P/L	Part No.	Pack Qty	L (inch)	N (inch)	Design
1/2	601	<b>429-005</b>	100	1.69	0.13	
3/4	601	<b>429-007</b>	50	1.69	0.13	
1	601	<b>429-010</b>	50	2.06	0.13	
1 1/4	601	<b>429-012</b>	25	2.63	0.13	
1 1/2	601	<b>429-015</b>	25	2.75	0.13	
2	601	<b>429-020</b>	25	2.88	0.13	
2 1/2	601	<b>429-025</b>	10	4.06	0.19	
3	601	<b>429-030</b>	10	4.19	0.19	
4	601	<b>429-040</b>	5	4.25	0.19	
6	601	<b>429-060</b>	5	7.31	0.31	
8	601	<b>429-080</b>	4	9.25	0.25	
10	B09	<b>429-100</b>	1	10.31	0.31	
12	B09	<b>429-120</b>	1	12.38	0.31	
14	A32	<b>429-140N</b>	1	16.50	2.50	FAB
16	A32	<b>429-160N</b>	1	19.00	3.00	FAB
18	A32	<b>429-180N</b>	1	21.75	3.75	FAB
20	A32	<b>429-200N</b>	1	24.13	4.13	FAB
24	A32	<b>429-240N</b>	1	28.00	4.00	FAB

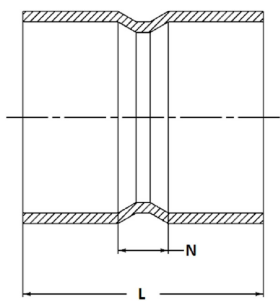
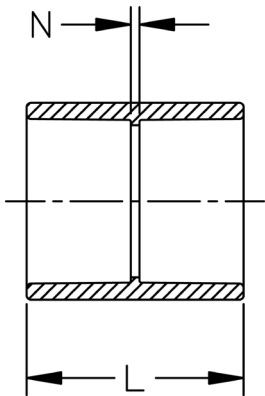

Image for 14"-24"  
Fabricated

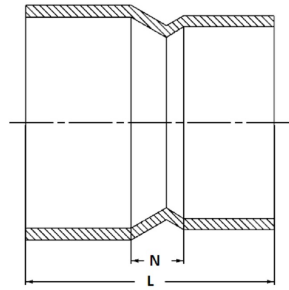
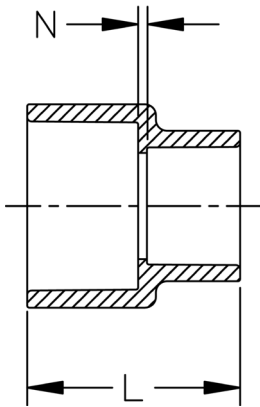

Image for 14"-24"  
Fabricated

### Reducing Coupling (S x S)

Size (inch)	P/L	Part No.	Pack Qty	L (inch)	N (inch)	Design
¾ x ½	601	<b>429-101</b>	50	1.63	0.13	
1 x ¾	601	<b>429-131</b>	50	2.13	0.25	
1 ¼ x 1	601	<b>429-168</b>	25	2.56	0.31	
1 ½ x 1 ¼	601	<b>429-212</b>	25	2.75	0.25	
2 x 1 ½	601	<b>429-251</b>	10	3.13	0.44	
3 x 2	601	<b>429-338</b>	5	4.06	0.63	
4 x 3	601	<b>429-422</b>	4	4.63	0.63	
6 x 4	601	<b>429-532</b>	4	6.63	1.19	
8 x 4	601	<b>429-582</b>	4	8.94	2.38	
8 x 6	601	<b>429-585</b>	4	9.06	1.06	
10 x 6	B09	<b>429-626</b>	1	10.81	2.69	
10 x 8	B09	<b>429-628</b>	1	10.75	1.69	
12 x 8	B09	<b>429-668</b>	1	12.88	2.69	
12 x 10	B09	<b>429-670</b>	1	13.06	1.94	
14 x 4	A32	<b>429-696N</b>	1	10.50	4.75	FAB
14 x 6	A32	<b>429-698N</b>	1	11.50	4.50	FAB
14 x 8	A32	<b>429-700N</b>	1	13.25	5.50	FAB
14 x 10	A32	<b>429-702N</b>	1	17.00	5.00	FAB
14 x 12	A32	<b>429-704N</b>	1	17.00	4.00	FAB
16 x 4	A32	<b>429-730N</b>	1	10.75	4.50	FAB
16 x 6	A32	<b>429-732N</b>	1	11.75	4.50	FAB
16 x 8	A32	<b>429-734N</b>	1	12.25	6.00	FAB
16 x 10	A32	<b>429-736N</b>	1	20.00	7.00	FAB
16 x 12	A32	<b>429-738N</b>	1	18.38	4.38	FAB
16 x 14	A32	<b>429-740N</b>	1	18.50	3.50	FAB
18 x 6	A32	<b>429-786N</b>	1	12.75	5.00	FAB
18 x 8	A32	<b>429-788N</b>	1	14.00	6.00	FAB
18 x 10	A32	<b>429-790N</b>	1	15.75	6.00	FAB
18 x 12	A32	<b>429-792N</b>	1	22.38	7.38	FAB
18 x 14	A32	<b>429-794N</b>	1	22.25	6.25	FAB
18 x 16	A32	<b>429-796N</b>	1	22.38	5.38	FAB
20 x 8	A32	<b>429-818N</b>	1	14.00	5.75	FAB
20 x 10	A32	<b>429-820N</b>	1	34.50	19.25	FAB
20 x 12	A32	<b>429-822N</b>	1	34.75	17.00	FAB
20 x 14	A32	<b>429-824N</b>	1	33.00	15.75	FAB
20 x 16	A32	<b>429-826N</b>	1	23.75	5.75	FAB
20 x 18	A32	<b>429-828N</b>	1	23.50	4.50	FAB
24 x 6	A32	<b>429-906N</b>	1	14.50	5.25	FAB
24 x 8	A32	<b>429-908N</b>	1	16.00	6.00	FAB
24 x 10	A32	<b>429-910N</b>	1	18.00	7.00	FAB
24 x 12	A32	<b>429-912N</b>	1	40.50	21.75	FAB
24 x 14	A32	<b>429-914N</b>	1	40.50	21.50	FAB
24 x 16	A32	<b>429-916N</b>	1	40.50	20.25	FAB
24 x 18	A32	<b>429-918N</b>	1	29.75	8.75	FAB
24 x 20	A32	<b>429-920N</b>	1	28.50	6.50	FAB



### Coupling (FPT x FPT)

Size (inch)	P/L	Part No.	Pack Qty	L (inch)	T (inch)
½	601	<b>430-005</b>	100	1.56	0.69
¾	601	<b>430-007</b>	50	1.81	0.97
1	601	<b>430-010</b>	50	1.56	1.00
2	601	<b>430-020</b>	25	1.75	0.94

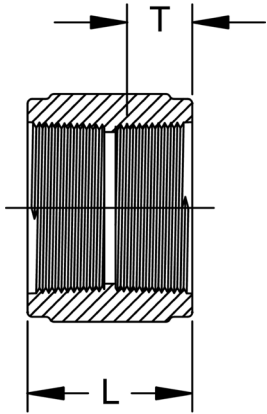

### Female Adapter (S x FPT)

Size (inch)	P/L	Part No.	Pack Qty	L (inch)	N (inch)
½	601	<b>435-005</b>	100	1.75	0.31
¾	601	<b>435-007</b>	50	1.75	0.31
1	601	<b>435-010</b>	50	2.19	0.13
1 ¼	601	<b>435-012</b>	25	2.25	0.06
1 ½	601	<b>435-015</b>	25	2.25	0.06
2	601	<b>435-020</b>	25	2.44	0.06
2 ½	601	<b>435-025</b>	10	3.75	0.19
3	601	<b>435-030</b>	10	3.75	0.19
4	601	<b>435-040</b>	5	4.00	0.19
6	601	<b>435-060</b>	4	5.75	0.25
8	601	<b>435-080</b>	4	6.94	0.25

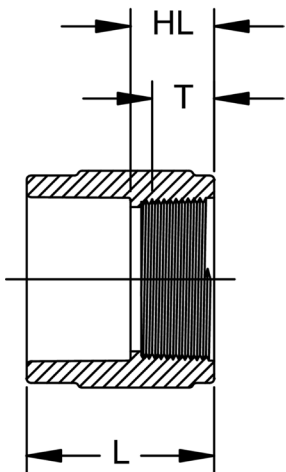



### Reducing Female Adapter (S x FPT)

Size (inch)	P/L	Part No.	Pack Qty	L (inch)	N (inch)	T (inch)
¾ x ½	601	<b>435-101</b>	50	1.56	0.13	0.69
¾ x 1	601	<b>435-102</b>	50	1.75	0.06	1.00
1 x ¾	601	<b>435-131</b>	50	1.88	0.00	0.88
1 x 1 ½	601	<b>435-211</b>	25	2.19	0.19	1.00

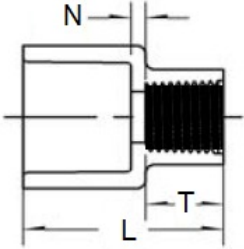

### Male Adapter (MPT x S)

Size (inch)	P/L	Part No.	Pack Qty	HL (inch)	L (inch)
½	601	<b>436-005</b>	100	0.69	1.56
¾	601	<b>436-007</b>	50	0.25	1.56
1	601	<b>436-010</b>	50	1.00	2.00
1 ¼	601	<b>436-012</b>	25	1.25	2.50
1 ½	601	<b>436-015</b>	25	1.19	2.50
2	601	<b>436-020</b>	25	1.31	2.69
2 ½	601	<b>436-025</b>	10	1.88	3.88
3	601	<b>436-030</b>	10	1.94	3.94
4	601	<b>436-040</b>	5	2.06	4.06
6	601	<b>436-060</b>	4	2.38	5.88
8	601	<b>436-080</b>	4	2.56	7.13
12	A32	<b>436-120N</b>	1	5.00	10.50

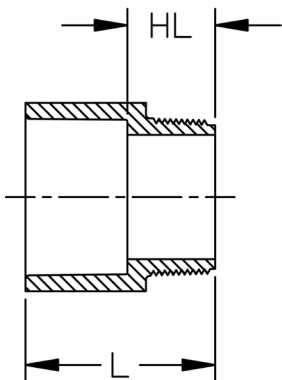

### Reducing Male Adapter (MPT x S)

Size (inch)	P/L	Part No.	Pack Qty	HL (inch)	L (inch)
½ x ¾	601	<b>436-074</b>	50	0.88	1.75
¾ x ½	601	<b>436-101</b>	50	0.94	1.69
¾ x 1	601	<b>436-102</b>	50	0.81	1.81
1 x ¾	601	<b>436-131</b>	50	1.00	2.31
1 x 1 ¼	601	<b>436-132</b>	25	1.19	2.88
1 ¼ x 1	601	<b>436-168</b>	25	1.00	2.00
1 ¼ x 1 ½	601	<b>436-169</b>	25	0.94	2.31
1 ½ x 1 ¼	601	<b>436-212</b>	25	1.19	2.50
1 ½ x 2	601	<b>436-213</b>	10	1.25	2.63
2 x 1 ½	601	<b>436-251</b>	10	1.25	2.56

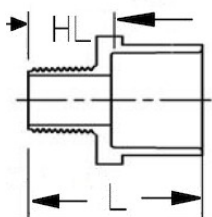

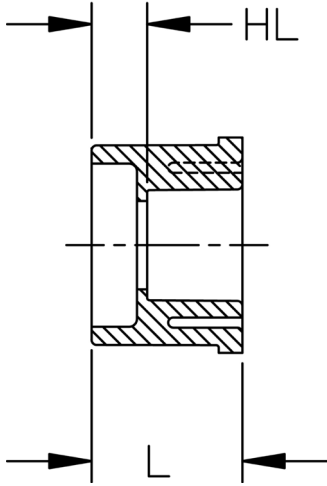

### Reducer Bushing (SPG x S)

Size (inch)	P/L	Part No.	Pack Qty	HL (inch)	L (inch)
¾ x ½	601	<b>437-101</b>	100	0.25	1.06
1 x ½	601	<b>437-130</b>	100	0.50	1.25
1 x ¾	601	<b>437-131</b>	100	0.44	1.25
1 ¼ x ½	601	<b>437-166</b>	25	0.81	1.56
1 ¼ x ¾	601	<b>437-167</b>	25	0.75	1.50
1 ¼ x 1	601	<b>437-168</b>	25	0.44	1.50
1 ½ x ½	601	<b>437-209</b>	25	0.88	1.63
1 ½ x ¾	601	<b>437-210</b>	25	0.81	1.63
1 ½ x 1	601	<b>437-211</b>	25	0.69	1.69
1 ½ x 1 ¼	601	<b>437-212</b>	25	0.38	1.56
2 x ½	601	<b>437-247</b>	10	0.94	1.69
2 x 1	601	<b>437-249</b>	10	0.56	1.63
2 x ¾	601	<b>437-248</b>	10	0.88	1.69
2 x 1 ¼	601	<b>437-250</b>	10	0.44	1.69
2 x 1 ½	601	<b>437-251</b>	25	0.38	1.69
2 ½ x 1	601	<b>437-289</b>	10	1.31	2.31
2 ½ x 1 ¼	601	<b>437-290</b>	10	1.00	2.25
2 ½ x 1 ½	601	<b>437-291</b>	10	1.00	2.31
2 ½ x 2	601	<b>437-292</b>	10	0.88	2.25
3 x 1	601	<b>437-335</b>	10	1.44	2.38
3 x 1 ¼	601	<b>437-336</b>	10	1.25	2.44
3 x 1 ½	601	<b>437-337</b>	10	1.13	2.38
3 x 2	601	<b>437-338</b>	10	1.00	2.38
3 x 2 ½	601	<b>437-339</b>	10	0.38	2.38
4 x 2	601	<b>437-420</b>	5	1.00	2.38
4 x 2 ½	601	<b>437-421</b>	5	0.56	2.44
4 x 3	601	<b>437-422</b>	5	0.38	2.38
6 x 3	601	<b>437-530</b>	5	2.06	4.06
6 x 4	601	<b>437-532</b>	5	2.00	4.00
8 x 4	601	<b>437-582</b>	5	3.25	5.25
8 x 6	601	<b>437-585</b>	5	1.75	5.25
10 x 4	B09	<b>437-624</b>	1	4.38	6.38
10 x 6	B09	<b>437-626</b>	1	2.44	5.44
10 x 8	B09	<b>437-628</b>	1	1.38	5.44
12 x 3	B09	<b>437-661</b>	1	5.38	7.38
12 x 4	B09	<b>437-664</b>	1	5.63	7.63
12 x 6	B09	<b>437-666</b>	1	4.13	7.69
12 x 8	B09	<b>437-668</b>	1	2.38	6.44
12 x 10	B09	<b>437-670</b>	1	1.44	6.50



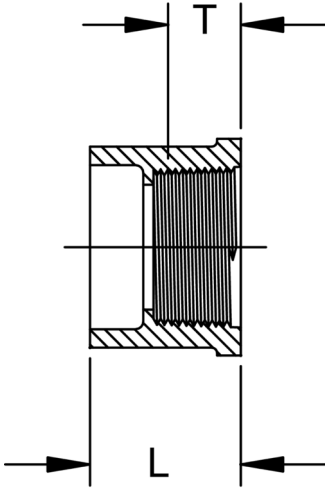

### Reducer Bushing (SPG x FPT)

Size (inch)	P/L	Part No.	Pack Qty	L (inch)	T (inch)
1/2 x 1/4	601	438-072	100	1.19	0.69
1/2 x 3/8	601	438-073	100	1.25	0.63
3/4 x 1/4	601	438-098	50	1.13	0.63
3/4 x 1/2	601	438-101	100	1.06	0.81
1 x 1/2	601	438-130	100	1.25	0.75
1 x 3/4	601	438-131	100	1.25	0.69
1 1/4 x 1/2	601	438-166	25	1.56	1.06
1 1/4 x 3/4	601	438-167	25	1.56	0.75
1 1/4 x 1	601	438-168	25	1.56	1.00
1 1/2 x 1/2	601	438-209	25	1.56	0.69
1 1/2 x 3/4	601	438-210	25	1.56	0.69
1 1/2 x 1	601	438-211	25	1.56	0.88
1 1/2 x 1 1/4	601	438-212	25	1.63	1.38
2 x 1/2	601	438-247	10	1.69	0.75
2 x 3/4	601	438-248	10	1.69	0.69
2 x 1	601	438-249	10	1.75	1.13
2 x 1 1/4	601	438-250	10	1.69	1.38
2 x 1 1/2	601	438-251	10	1.69	0.94
2 1/2 x 1 1/2	601	438-291	10	2.31	1.31
2 1/2 x 2	601	438-292	10	2.31	1.50
3 x 1 1/2	601	438-337	10	2.38	0.88
3 x 2	601	438-338	10	2.38	1.00
3 x 2 1/2	601	438-339	10	2.38	1.50
4 x 2	601	438-420	5	2.44	1.00
4 x 2 1/2	601	438-421	5	2.44	1.31
4 x 3	601	438-422	5	2.38	1.38
6 x 4	601	438-532	5	3.88	1.69

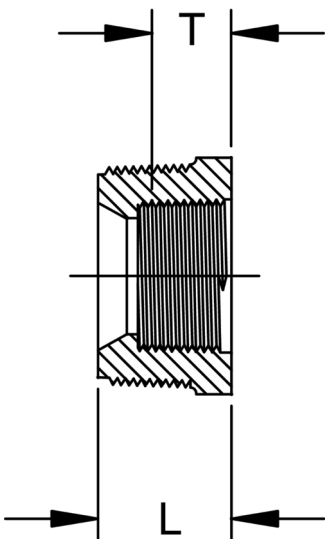

### Reducer Bushing (MPT x FPT)

Size (inch)	P/L	Part No.	Pack Qty	L (inch)	T (inch)
1/2 x 1/4	601	439-072	50	1.13	0.63
1/2 x 3/8	601	439-073	50	1.13	0.69
3/4 x 1/4	601	439-098	50	1.13	0.69
3/4 x 1/2	601	439-101	50	1.00	0.75
1 x 1/2	601	439-130	50	1.06	0.75
1 x 3/4	601	439-131	50	1.13	0.75
1 1/4 x 1/2	601	439-166	25	1.31	0.75
1 1/4 x 3/4	601	439-167	25	1.31	0.50
1 1/4 x 1	601	439-168	25	1.31	1.00
1 1/2 x 1/2	601	439-209	25	1.38	0.75
1 1/2 x 3/4	601	439-210	25	1.44	0.81
1 1/2 x 1	601	439-211	25	1.44	1.13
1 1/2 x 1 1/4	601	439-212	25	1.44	1.00
2 x 1	601	439-249	10	1.44	1.00
2 x 1 1/4	601	439-250	10	1.44	1.00
2 x 1 1/2	601	439-251	10	1.50	1.00
2 1/2 x 2	601	439-292	10	1.81	1.06
3 x 2	601	439-338	5	2.06	1.06

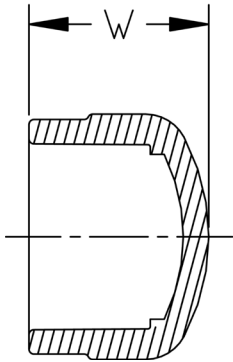

### Cap (S)

Size (inch)	P/L	Part No.	Pack Qty	W (inch)	Design
½	601	<b>447-005</b>	100	1.19	
¾	601	<b>447-007</b>	100	1.31	
1	601	<b>447-010</b>	50	1.75	
1 ¼	601	<b>447-012</b>	25	1.75	
1 ½	601	<b>447-015</b>	25	2.00	
2	601	<b>447-020</b>	25	2.19	
2 ½	601	<b>447-025</b>	10	3.06	
3	601	<b>447-030</b>	10	3.19	
4	601	<b>447-040</b>	5	3.50	
6	601	<b>447-060</b>	5	5.38	
8	601	<b>447-080</b>	4	6.69	
10	B09	<b>447-100</b>	1	8.50	
12	B09	<b>447-120</b>	1	9.63	
14	A32	<b>447-140N</b>	1	5.00	FAB
16	A32	<b>447-160N</b>	1	5.25	FAB
18	A32	<b>447-180N</b>	1	6.25	FAB
20	A32	<b>447-200N</b>	1	6.75	FAB
24	A32	<b>447-240N</b>	1	8.00	FAB

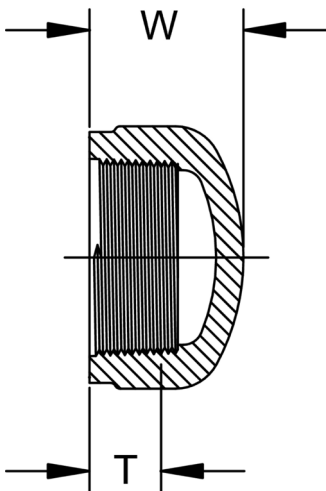

### Cap (FPT)

Size (inch)	P/L	Part No.	Pack Qty	W (inch)	T (inch)
½	601	<b>448-005</b>	100	1.06	0.75
¾	601	<b>448-007</b>	100	1.13	0.81
1	601	<b>448-010</b>	50	1.25	1.00
1 ¼	601	<b>448-012</b>	25	1.50	1.31
1 ½	601	<b>448-015</b>	25	1.56	1.06
2	601	<b>448-020</b>	10	1.75	1.44
2 ½	601	<b>448-025</b>	10	2.56	2.13
3	601	<b>448-030</b>	10	3.13	2.00
4	601	<b>448-040</b>	5	3.25	2.19

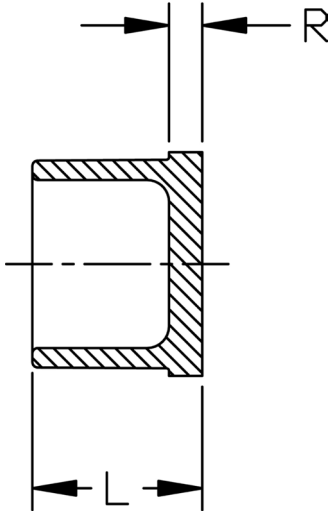

### Plug (SPG)

Size (inch)	P/L	Part No.	Pack Qty	L (inch)	R (inch)
½	601	<b>449-005</b>	50	1.00	0.25
¾	601	<b>449-007</b>	50	1.06	0.25
1	601	<b>449-010</b>	50	1.25	0.25
1 ¼	601	<b>449-012</b>	25	1.56	0.31
1 ½	601	<b>449-015</b>	25	1.63	0.31
2	601	<b>449-020</b>	10	1.69	0.31
2 ½	601	<b>449-025</b>	10	2.38	0.38
3	601	<b>449-030</b>	10	2.38	0.38
4	601	<b>449-040</b>	5	2.38	0.38

### Plug (MPT)

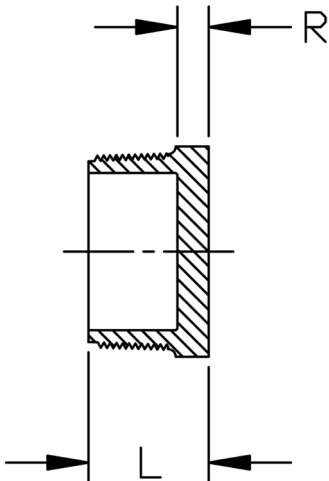

Size (inch)	P/L	Part No.	Pack Qty	L (inch)	R (inch)
½	601	<b>450-005</b>	50	1.00	0.25
¾	601	<b>450-007</b>	50	1.06	0.31
1	601	<b>450-010</b>	50	1.13	0.31
1 ¼	601	<b>450-012</b>	25	1.25	0.44
1 ½	601	<b>450-015</b>	25	1.38	0.31
2	601	<b>450-020</b>	10	1.38	0.31
2 ½	601	<b>450-025</b>	10	1.94	0.38
3	601	<b>450-030</b>	10	2.00	0.31
4	601	<b>450-040</b>	5	2.13	0.38
6	A32	<b>450-060N</b>	1	2.00	1.00
8	A32	<b>450-080N</b>	1	2.00	1.00
10	A32	<b>450-100N</b>	1	2.00	1.00
12	A32	<b>450-120N</b>	1	2.00	1.00

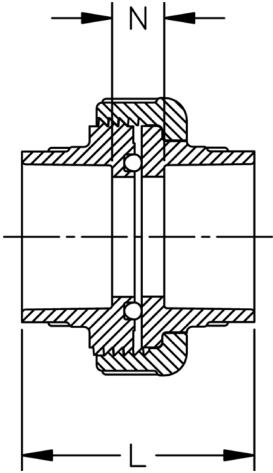

### Union (S x S)

- 150 psi @ 73°F (10.3 bar @ 22.7°C)
- O-ring material Buna-N

Size (inch)	P/L	Part No.	Pack Qty	L (inch)	N (inch)
½	601	<b>457-005</b>	10	1.75	0.25
¾	601	<b>457-007</b>	10	1.88	0.25
1	601	<b>457-010</b>	10	2.38	0.25
1 ¼	601	<b>457-012</b>	5	2.81	0.38
1 ½	601	<b>457-015</b>	5	3.00	0.38
2	601	<b>457-020</b>	5	3.13	0.38

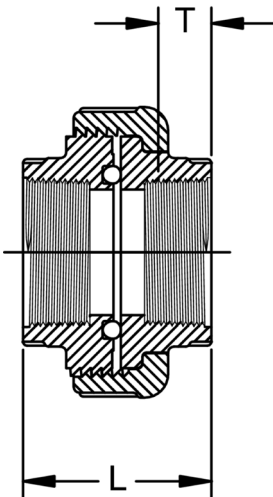

### Union (FPT x FPT)

- 150 psi @ 73°F (10.3 bar @ 22.7°C)
- O-ring material Buna-N

Size (inch)	P/L	Part No.	Pack Qty	L (inch)	T (inch)
½	601	<b>458-005</b>	10	1.75	0.75
¾	601	<b>458-007</b>	10	1.88	0.81
1	601	<b>458-010</b>	10	2.44	1.06
1 ¼	601	<b>458-012</b>	5	2.81	1.13
1 ½	601	<b>458-015</b>	5	3.00	1.06
2	601	<b>458-020</b>	5	3.13	1.19

## Section 4

# Specialty Pipe

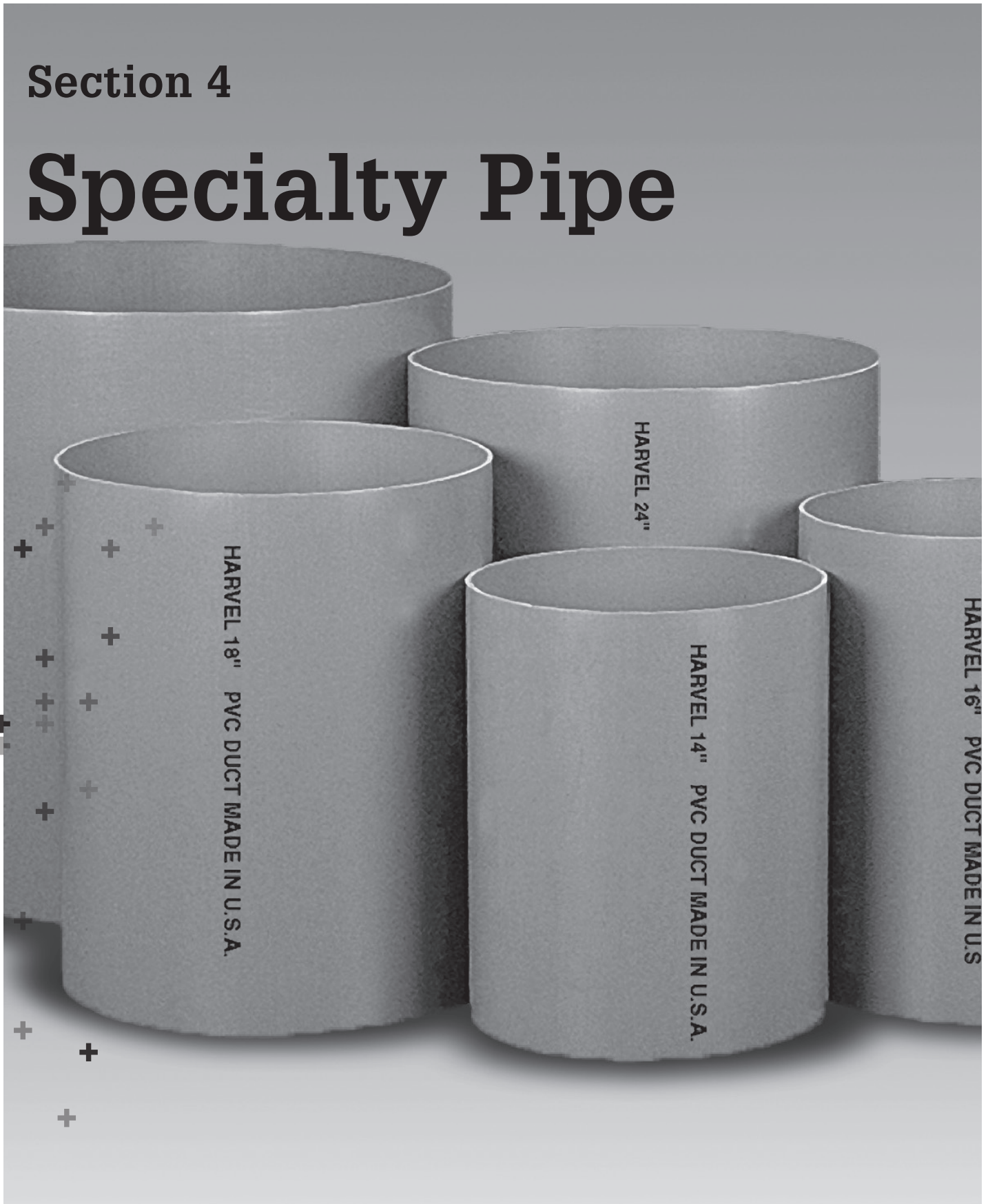

The technical information given in this publication implies no warranty of any kind and is subject to change without notice. Please consult our Terms and Conditions of Sale.

For complete technical information, please consult the Vinyl Catalog and Technical Information

**For more information about any of our product lines, please visit [www.gfps.com](http://www.gfps.com)**



**Table of contents**

**Page**

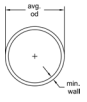

Harvel Specialized PVC Pipe Sizes

203

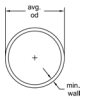

Corrosion Resistant Duct

206

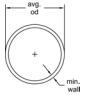

EnviroKing® UV Resistant Pipe

207

# Specifications and Standards

## Specifications and Standards

NSF/ANSI Standard 14

NSF/ANSI Standard 61

- ASTM D 1784 : Material PVC Type I, Grade I, White or Gray, Cell Classification 12454 (SDR Series Pipe & PVC Duct)  
Material CPVC Type IV, Grade I, Tan, Cell Classification 24448 (CTS CPVC Plumbing Pipe)  
Material CPVC Type IV, Grade I, Gray, Cell Classification 23447 (CPVC Duct)
- ASTM D 1785 : PVC Schedule 120 Pipe
- ASTM D 2241 : PVC SDR Series Pipe
- ULC S102.2 : CPVC Corrosion Resistant Duct (6"-24")

P1300127

# Harvel Specialized PVC Pipe Sizes

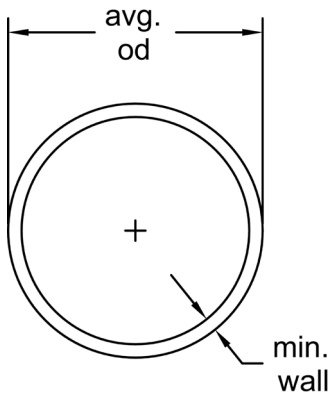

## Schedule 120 PVC Pressure Pipe - Gray

- Max Water Pressure at 73°F (22.7°C) with solvent-cemented joints
- Belled-end pipe available upon request

Pipe Size (inch)	P/L	Part No.	Lift Qty (ft)	Average O.D. (inch)	min. wall (inch)	Wt/Ft (lbs/ft)	Max Water Pressure (psi)
½	H15	H1200050PG2000	5700	0.840	0.170	0.223	1010
¾	H15	H1200075PG2000	5260	1.050	0.170	0.295	770
1	H15	H1200100PG2000	4280	1.315	0.200	0.440	720
1 ¼	H15	H1200125PG2000	2360	1.660	0.215	0.614	600
1 ½	H15	H1200150PG2000	2060	1.900	0.225	0.744	540
2	H15	H1200200PG2000	1660	2.375	0.250	1.052	470
2 ½	H15	H1200250PG2000	1080	2.875	0.300	1.529	470
3	H15	H1200300PG2000	840	3.500	0.350	2.184	440
4	H15	H1200400PG2000	520	4.500	0.437	3.516	430
6	H15	H1200600PG2000	340	6.625	0.562	6.759	370
8	H15	H1200800PG2000	220	8.625	0.718	11.251	380

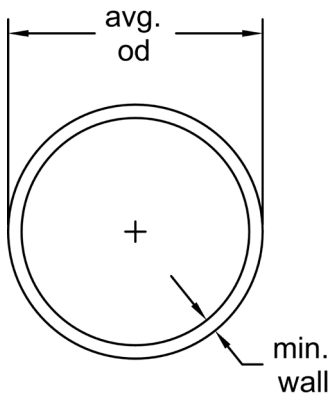

## SDR 13.5 PVC Pressure Pipe - Gray

- Max Water Pressure at 73°F (22.7°C) with solvent-cemented joints
- Belled-end pipe available upon request

Pipe Size (inch)	P/L	Part No.	Lift Qty (ft)	Average O.D. (inch)	min. wall (inch)	Wt/Ft (lbs/ft)	Max Water Pressure (psi)
½	H21	H1350050PG2000	5700	0.840	0.062	0.104	315

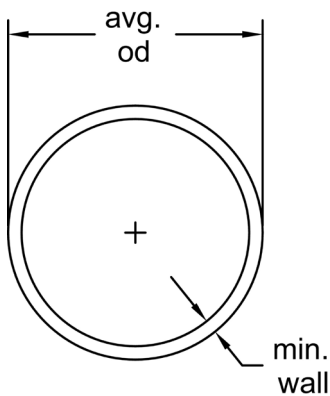

## SDR 13.5 PVC Pressure Pipe - White

- Max Water Pressure at 73°F (22.7°C) with solvent-cemented joints
- Belled-end pipe available upon request

Pipe Size (inch)	P/L	Part No.	Lift Qty (ft)	Average O.D. (inch)	min. wall (inch)	Wt/Ft (lbs/ft)	Max Water Pressure (psi)
½	H21	H1350050PW2000	5700	0.840	0.062	0.104	315

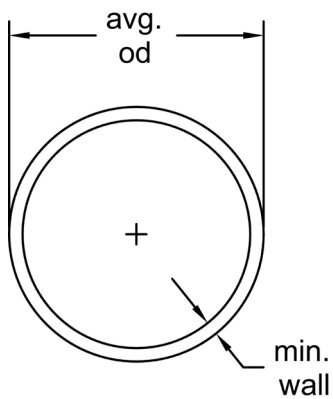

### SDR 21 PVC Pressure Pipe - Gray

- Max Water Pressure at 73°F (22.7°C) with solvent-cemented joints
- Belled-end pipe available upon request

Pipe Size (inch)	P/L	Part No.	Lift Qty (ft)	Average O.D. (inch)	min. wall (inch)	Wt/Ft (lbs/ft)	Max Water Pressure (psi)
3/4	H21	H0210075PG2000	5260	1.050	0.060	0.129	200
1	H21	H0210100PG2000	4280	1.315	0.063	0.170	200
1 1/4	H21	H0210125PG2000	2360	1.660	0.079	0.263	200
1 1/2	H21	H0210150PG2000	2060	1.900	0.090	0.339	200
2	H21	H0210200PG2000	1660	2.375	0.113	0.521	200
2 1/2	H21	H0210250PG2000	1080	2.875	0.137	0.754	200
3	H21	H0210300PG2000	840	3.500	0.167	1.106	200
3 1/2	H21	H0210350PG2000	580	4.000	0.190	1.443	200
4	H21	H0210400PG2000	520	4.500	0.214	1.825	200
5	H21	H0210500PG2000	400	5.563	0.265	2.792	200
6	H21	H0210600PG2000	340	6.625	0.316	3.964	200
8	H21	H0210800PG2000	220	8.625	0.410	6.679	200

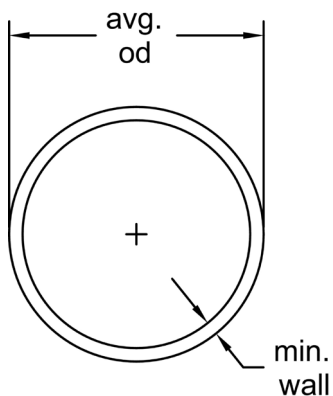

### SDR 21 PVC Pressure Pipe - White

- Max Water Pressure at 73°F (22.7°C) with solvent-cemented joints
- Belled-end pipe available upon request

Pipe Size (inch)	P/L	Part No.	Lift Qty (ft)	Average O.D. (inch)	min. wall (inch)	Wt/Ft (lbs/ft)	Max Water Pressure (psi)
3/4	H21	H0210075PW2000	5260	1.050	0.060	0.129	200
1	H21	H0210100PW2000	4280	1.315	0.063	0.170	200
1 1/4	H21	H0210125PW2000	2360	1.660	0.079	0.263	200
1 1/2	H21	H0210150PW2000	2060	1.900	0.090	0.339	200
2	H21	H0210200PW2000	1660	2.375	0.113	0.521	200
2 1/2	H21	H0210250PW2000	1080	2.875	0.137	0.754	200
3	H21	H0210300PW2000	840	3.500	0.167	1.106	200
3 1/2	H21	H0210350PW2000	580	4.000	0.190	1.443	200
4	H21	H0210400PW2000	520	4.500	0.214	1.825	200
5	H21	H0210500PW2000	400	5.563	0.265	2.792	200
6	H21	H0210600PW2000	340	6.625	0.316	3.964	200
8	H21	H0210800PW2000	220	8.625	0.410	6.679	200

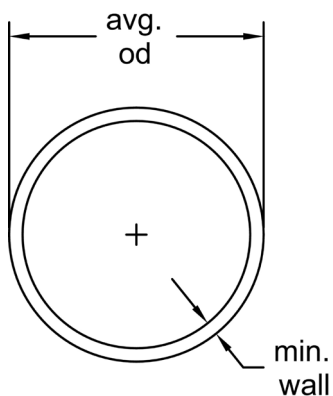

### SDR 26 PVC Pressure Pipe - Gray

- Max Water Pressure at 73°F (22.7°C) with solvent-cemented joints
- Belled-end pipe available upon request

Pipe Size (inch)	P/L	Part No.	Lift Qty (ft)	Average O.D. (inch)	min. wall (inch)	Wt/Ft (lbs/ft)	Max Water Pressure (psi)
1	H21	H0260100PG2000	4280	1.315	0.060	0.164	160
1 1/4	H21	H0260125PG2000	2360	1.660	0.064	0.221	160
1 1/2	H21	H0260150PG2000	2060	1.900	0.073	0.284	160
2	H21	H0260200PG2000	1660	2.375	0.091	0.432	160
2 1/2	H21	H0260250PG2000	1080	2.875	0.110	0.622	160
3	H21	H0260300PG2000	840	3.500	0.135	0.915	160
3 1/2	H21	H0260350PG2000	700	4.000	0.154	1.183	160
4	H21	H0260400PG2000	520	4.500	0.173	1.494	160
5	H21	H0260500PG2000	400	5.563	0.214	2.288	160
6	H21	H0260600PG2000	340	6.625	0.255	3.228	160
8	H21	H0260800PG2000	220	8.625	0.332	5.468	160
10	H21	H0261000PG2000	80	10.750	0.413	8.492	160
12	H21	H0261200PG2000	60	12.750	0.490	11.956	160

table continued on the next page

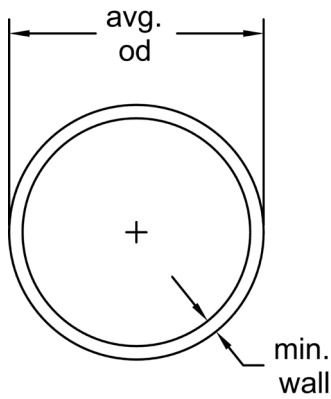

Pipe Size (inch)	P/L	Part No.	Lift Qty (ft)	Average O.D. (inch)	min. wall (inch)	Wt/Ft (lbs/ft)	Max Water Pressure (psi)
14	H21	H0261400PG2000	60	14.000	0.538	14.430	160
16	H21	H0261600PG2000	60	16.000	0.615	18.810	160
18	H21	H0261800PG2000	40	18.000	0.692	23.860	160
20	H21	H0262000PG2000	40	20.000	0.769	29.470	160
24	H21	H0262400PG2000	40	24.000	0.923	42.520	160

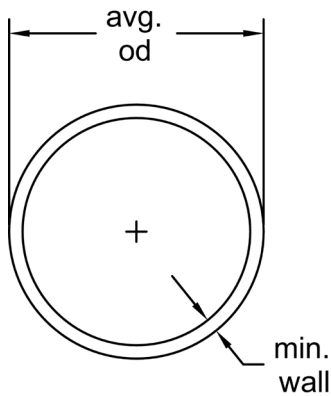

### SDR 26 PVC Pressure Pipe - White

- Max Water Pressure at 73°F (22.7°C) with solvent-cemented joints
- Belled-end pipe available upon request

Pipe Size (inch)	P/L	Part No.	Lift Qty (ft)	Average O.D. (inch)	min. wall (inch)	Wt/Ft (lbs/ft)	Max Water Pressure (psi)
1	H21	H0260100PW2000	4280	1.315	0.060	0.164	160
1 1/4	H21	H0260125PW2000	2360	1.660	0.064	0.221	160
1 1/2	H21	H0260150PW2000	2060	1.900	0.073	0.284	160
2	H21	H0260200PW2000	1660	2.375	0.091	0.432	160
2 1/2	H21	H0260250PW2000	1080	2.875	0.110	0.622	160
3	H21	H0260300PW2000	840	3.500	0.135	0.915	160
3 1/2	H21	H0260350PW2000	700	4.000	0.154	1.183	160
4	H21	H0260400PW2000	520	4.500	0.173	1.494	160
5	H21	H0260500PW2000	400	5.563	0.214	2.288	160
6	H21	H0260600PW2000	340	6.625	0.255	3.228	160
8	H21	H0260800PW2000	220	8.625	0.332	5.468	160
10	H21	H0261200PW2000	80	10.750	0.413	8.492	160
12	H21	H0261000PW2000	60	12.750	0.490	11.956	160
14	H21	H0261400PW2000	60	14.000	0.538	14.430	160
16	H21	H0261600PW2000	60	16.000	0.615	18.810	160
18	H21	H0261800PW2000	40	18.000	0.692	23.860	160
20	H21	H0262000PW2000	40	20.000	0.769	29.470	160
24	H21	H0262400PW2000	40	24.000	0.923	42.520	160

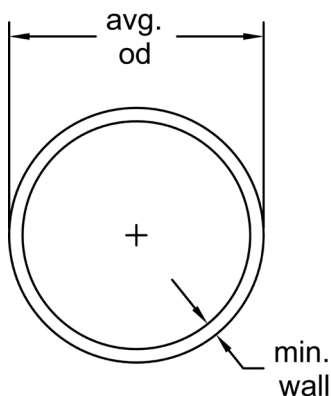

### SDR 41 PVC Pressure Pipe - Gray

- Max Water Pressure at 73°F (22.7°C) with solvent-cemented joints
- Belled-end pipe available upon request

Pipe Size (inch)	P/L	Part No.	Lift Qty (ft)	Average O.D. (inch)	min. wall (inch)	Wt/Ft (lbs/ft)	Max Water Pressure (psi)
18	H15	H0411800PG2000	60	18.000	0.439	15.370	100
20	H15	H0412000PG2000	40	20.000	0.488	18.920	100
24	H15	H0412400PG2000	40	24.000	0.585	27.320	100

# Corrosion Resistant Duct

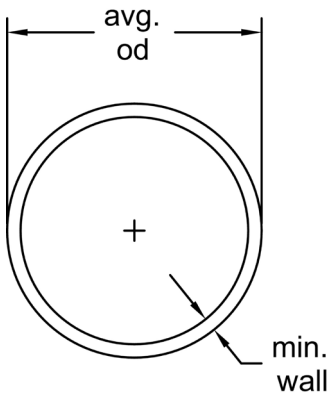

## Harvel® PVC Duct

- Belled-end pipe available upon request

Size (inch) (inch)	P/L	Part No.	Lift Qty (ft)	Average O.D. (inch)	min. wall (inch)	Wt/Ft (lbs/ft)
6 x 1/8	H30	HDUC0600PG2000	340	6.625	0.105	1.530
6	H30	HDUC0601PG2000	340	6.625	0.172	2.275
7	H30	HDUC0700PG2000	340	7.737	0.172	2.534
8	H30	HDUC0800PG2000	220	8.625	0.172	2.982
9	H30	HDUC0900PG2000	80	9.375	0.172	3.239
10	H30	HDUC1000PG2000	80	10.750	0.172	3.733
11	H30	HDUC1100PG2000	60	11.375	0.172	3.944
12	H30	HDUC1200PG2000	60	12.750	0.172	4.440
14	H30	HDUC1400PG2000	60	14.000	0.172	4.884
16	H30	HDUC1600PG2000	60	16.000	0.172	5.586
18	H30	HDUC1800PG2000	40	18.000	0.172	6.750
20	H30	HDUC2000PG2000	40	20.000	0.199	8.144
24	H30	HDUC2400PG2000	40	24.000	0.230	11.163

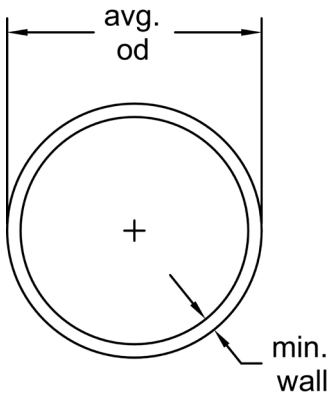

## Harvel® CORZAN® CPVC Duct

- Belled-end pipe available upon request

Size (inch)	P/L	Part No.	Lift Qty (ft)	Average O.D. (inch)	min. wall (inch)	Wt/Ft (lbs/ft)
6	H41	HDUC0600CG2000	340	6.625	0.172	2.555
8	H41	HDUC0800CG2000	220	8.625	0.172	3.349
10	H41	HDUC1000CG2000	80	10.750	0.172	4.192
12	H41	HDUC1200CG2000	80	12.750	0.172	4.986
14	H41	HDUC1400CG2000	60	14.000	0.172	5.485
16	H41	HDUC1600CG2000	60	16.000	0.172	6.273
18	H41	HDUC1800CG2000	40	18.000	0.172	7.580
20	H41	HDUC2000CG2000	40	20.000	0.199	9.146
24	H41	HDUC2400CG2000	40	24.000	0.230	12.536



# EnviroKing® UV Resistant Pipe

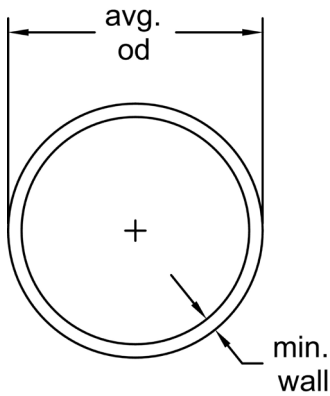

## EnviroKing® UV Resistant Clear PVC Pipe Thinwall - 10 ft lengths

- Max Water Pressure at 73°F (22.7°C) with solvent-cemented joints
- Must be purchased in full box qty
- 20ft Plain end length available upon request

Size (inch)	P/L	Part No.	Box Qty (ft)	Average O.D. (inch)	min. wall (inch)	Wt/Ft (lbs/ft)	Max Water Pressure (psi)
2	H20	HTW00200EK1000	120	2.375	0.091	0.456	80
3	H20	HTW00300EK1000	60	3.500	0.135	0.966	80
4	H20	HTW00400EK1000	40	4.500	0.173	1.569	80
6	H20	HTW00600EK1000	10	6.625	0.172	2.391	70
8	H20	HTW00800EK1000	10	8.625	0.172	3.134	53
10	H20	HTW01000EK1000	10	10.750	0.172	3.923	43
12	H20	HTW01200EK1000	10	12.750	0.172	4.666	36

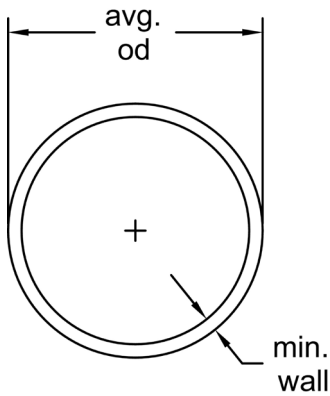

## EnviroKing® UV Resistant Clear PVC Pipe Schedule 40 - 10 ft lengths

- Max Water Pressure at 73°F (22.7°C) with solvent-cemented joints
- Must be purchased in full box qty
- 20ft Plain end length available upon request

Pipe Size (inch)	Part No.	Box Qty (ft)	Average O.D. (inch)	min. wall (inch)	Wt/Ft (lbs/ft)	Max Water Pressure (psi)
1/2	H0400050EK1000	350	0.840	0.109	0.170	300
3/4	H0400075EK1000	250	1.050	0.113	0.226	240
1	H0400100EK1000	250	1.315	0.133	0.333	220
1 1/4	H0400125EK1000	200	1.660	0.140	0.450	180
1 1/2	H0400150EK1000	160	1.900	0.145	0.537	170
2	H0400200EK1000	120	2.375	0.154	0.720	140
2 1/2	H0400250EK1000	80	2.875	0.203	1.136	150
3	H0400300EK1000	60	3.500	0.216	1.488	130
3 1/2	H0400350EK1000	40	4.000	0.226	1.789	120
4	H0400400EK1000	40	4.500	0.237	2.118	110
5	H0400500EK1000	10	5.563	0.258	2.726	95
6	H0400600EK1000	10	6.625	0.280	3.733	90



Section 5

# Extruded Shapes and Rods

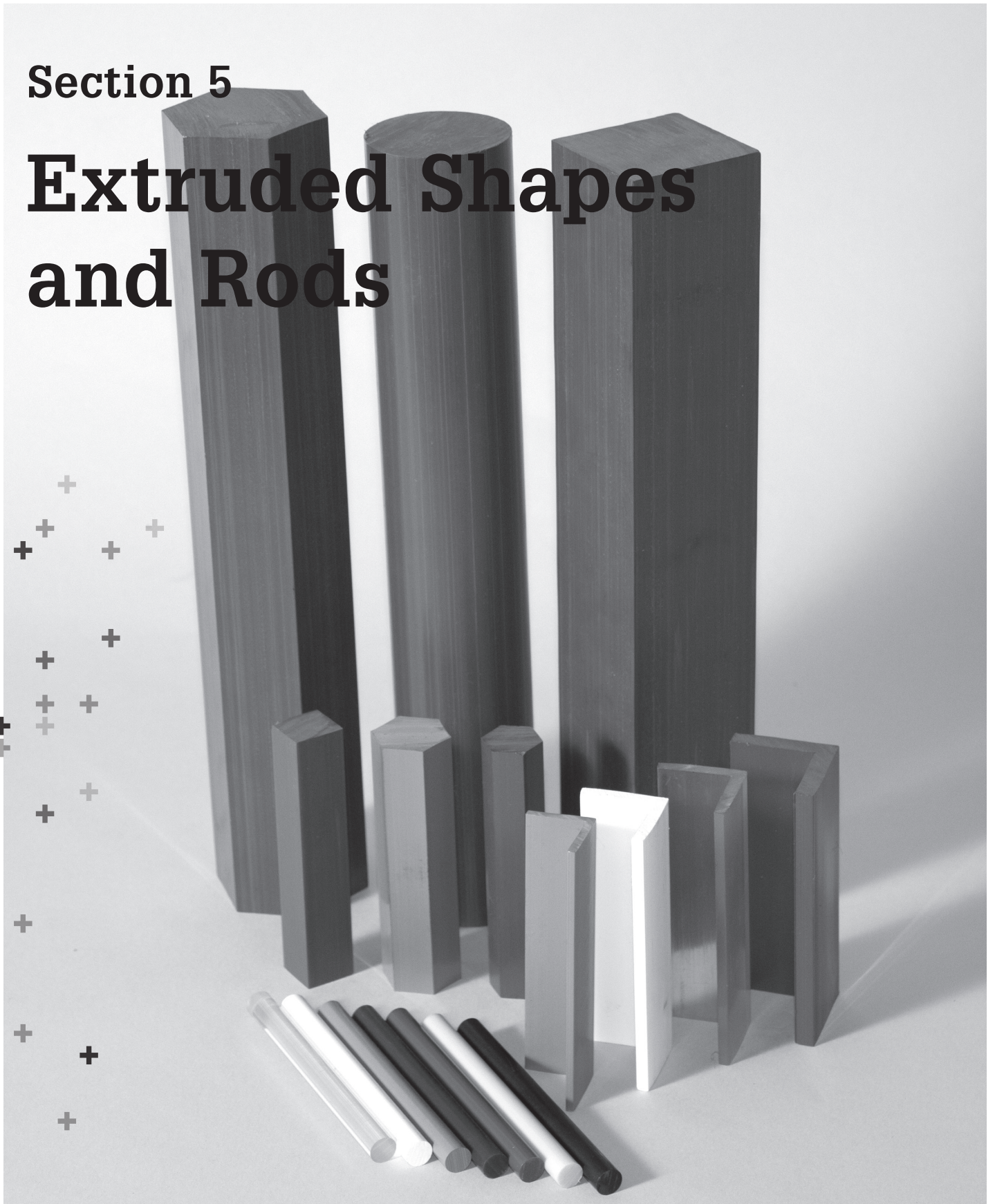

The technical information given in this publication implies no warranty of any kind and is subject to change without notice. Please consult our Terms and Conditions of Sale.

For complete technical information, please consult the Vinyl Catalog and Technical Information

**For more information about any of our product lines, please visit [www.gfps.com](http://www.gfps.com)**

## Table of contents

Page



PVC Extruded Shapes and Rods

213



CPVC Extruded Shapes and Rods

218

# Specifications and Standards

## Specifications and Standards

NSF/ANSI Standard 61

FDA Title 21 : Applies to PVC Type 2, Grade 1 (Clear) Cell Classification 16443

ASTM D 1784 : Material PVC Type I, Grade I (White, Gray, or Black) Cell Classification 12454

Material PVC Type 2, Grade I (Clear) Cell Classification 16443

Material CPVC Type IV, Grade I, Cell Classification 23447

The technical information given in this publication implies no warranty of any kind and is subject to change without notice. Please consult our Terms and Conditions of Sale.

For complete technical information, please consult the Vinyl Catalog and Technical Information

**For more information about any of our product lines, please visit [www.gfps.com](http://www.gfps.com)**



# PVC Extruded Shapes and Rods

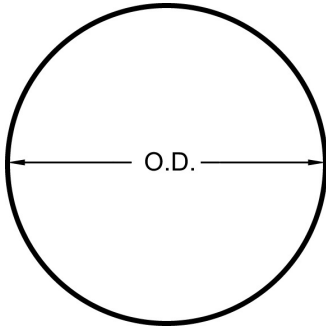

## Harvel® PVC Solid Round Bar - Gray

Pipe Size (inch)	P/L	Part No.	O.D. (inch)	Wt/Ft (lbs/ft)
¼	H32	<b>HROD0025PS1000</b>	0.250	0.029
⅜	H32	<b>HROD0038PS1000</b>	0.375	0.066
½	H32	<b>HROD0050PS1000</b>	0.500	0.117
⅝	H32	<b>HROD0063PS1000</b>	0.625	0.183
¾	H32	<b>HROD0075PS1000</b>	0.750	0.265
⅞	H32	<b>HROD0088PS1000</b>	0.875	0.358
1	H32	<b>HROD0100PS1000</b>	1.000	0.471
1 ⅛	H32	<b>HROD0113PS1000</b>	1.125	0.594
1 ¼	H32	<b>HROD0125PS1000</b>	1.250	0.736
1 ⅜	H32	<b>HROD0138PS1000</b>	1.375	0.891
1 ½	H32	<b>HROD0150PS1000</b>	1.500	1.600
1 ⅝	H32	<b>HROD0163PS1000</b>	1.625	1.244
1 ¾	H32	<b>HROD0175PS1000</b>	1.750	1.440
1 ⅞	H32	<b>HROD0188PS1000</b>	1.875	1.657
2	H32	<b>HROD0200PS1000</b>	2.000	1.890
2 ⅛	H32	<b>HROD0213PS1000</b>	2.125	2.128
2 ¼	H32	<b>HROD0225PS1000</b>	2.250	2.384
2 ⅜	H32	<b>HROD0238PS1000</b>	2.375	2.658
2 ½	H32	<b>HROD0250PS1000</b>	2.500	2.950
2 ¾	H32	<b>HROD0275PS1000</b>	2.750	3.560
3	H32	<b>HROD0300PS1000</b>	3.000	4.224
3 ¼	H32	<b>HROD0325PS1000</b>	3.250	4.975
3 ½	H32	<b>HROD0350PS1000</b>	3.500	5.770
4	H32	<b>HROD0400PS0500</b>	4.000	7.550
4 ½	H32	<b>HROD0450PS0500</b>	4.500	9.555
5	H32	<b>HROD0500PS0500</b>	5.000	11.700
5 ½	H32	<b>HROD0550PS0500</b>	5.500	14.300
6	H32	<b>HROD0600PS0500</b>	6.000	17.100
7	H32	<b>HROD0700PS0500</b>	7.000	24.010
8	H32	<b>HROD0800PS0500</b>	8.000	31.360
9	H32	<b>HROD0900PS0500</b>	9.000	39.690
10	H32	<b>HROD1000PS0500</b>	10.000	49.000

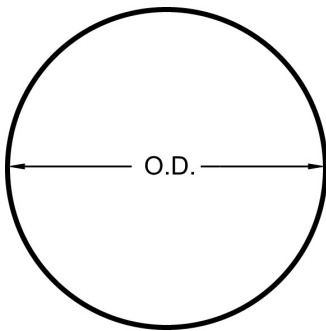

## Harvel® PVC Solid Round Bar - White

Pipe Size (inch)	P/L	Part No.	O.D. (inch)	Wt/Ft (lbs/ft)
¼	H34	<b>HROD0025PW1000</b>	0.250	0.029
⅜	H34	<b>HROD0038PW1000</b>	0.375	0.066
½	H34	<b>HROD0050PW1000</b>	0.500	0.117
⅝	H34	<b>HROD0063PW1000</b>	0.625	0.183
¾	H34	<b>HROD0075PW1000</b>	0.750	0.265
⅞	H34	<b>HROD0088PW1000</b>	0.875	0.358
1	H34	<b>HROD0100PW1000</b>	1.000	0.471
1 ⅛	H34	<b>HROD0113PW1000</b>	1.125	0.594
1 ¼	H34	<b>HROD0125PW1000</b>	1.250	0.736
1 ⅜	H34	<b>HROD0138PW1000</b>	1.375	0.891
1 ½	H34	<b>HROD0150PW1000</b>	1.500	1.060
1 ⅝	H34	<b>HROD0163PW1000</b>	1.625	1.244
1 ¾	H34	<b>HROD0175PW1000</b>	1.750	1.440
1 ⅞	H34	<b>HROD0188PW1000</b>	1.875	1.657
2	H34	<b>HROD0200PW1000</b>	2.000	1.890

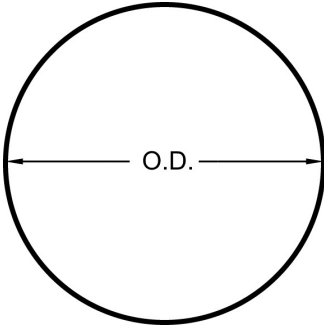

### Harvel® PVC Solid Round Bar - Black

Pipe Size (inch)	P/L	Part No.	O.D. (inch)	Wt/Ft (lbs/ft)
¼	H34	<b>HROD0025PK1000</b>	0.250	0.029
⅜	H34	<b>HROD0038PK1000</b>	0.375	0.066
½	H34	<b>HROD0050PK1000</b>	0.500	0.117
⅝	H34	<b>HROD0063PK1000</b>	0.625	0.183
¾	H34	<b>HROD0075PK1000</b>	0.750	0.265
⅞	H34	<b>HROD0088PK1000</b>	0.875	0.358
1	H34	<b>HROD0100PK1000</b>	1.000	0.471
1 ⅛	H34	<b>HROD0113PK1000</b>	1.125	0.594
1 ¼	H34	<b>HROD0125PK1000</b>	1.250	0.736
1 ⅜	H34	<b>HROD0138PK1000</b>	1.375	0.891
1 ½	H34	<b>HROD0150PK1000</b>	1.500	1.060
1 ⅝	H34	<b>HROD0163PK1000</b>	1.625	1.244
1 ¾	H34	<b>HROD0175PK1000</b>	1.750	1.440
1 ⅞	H34	<b>HROD0188PK1000</b>	1.875	1.657
2	H34	<b>HROD0200PK1000</b>	2.000	1.890

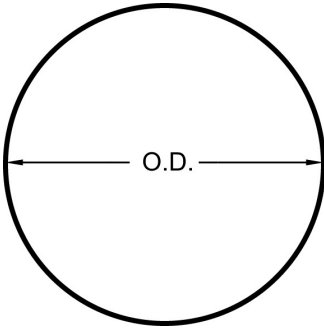

### Harvel® PVC Solid Round Bar - Clear

Pipe Size (inch)	P/L	Part No.	O.D. (inch)	Wt/Ft (lbs/ft)
¼	H39	<b>HROD0025PL1000</b>	0.250	0.029
⅜	H39	<b>HROD0038PL1000</b>	0.375	0.066
½	H39	<b>HROD0050PL1000</b>	0.500	0.117
⅝	H39	<b>HROD0063PL1000</b>	0.625	0.183
¾	H39	<b>HROD0075PL1000</b>	0.750	0.265
⅞	H39	<b>HROD0088PL1000</b>	0.875	0.358
1	H39	<b>HROD0100PL1000</b>	1.000	0.471

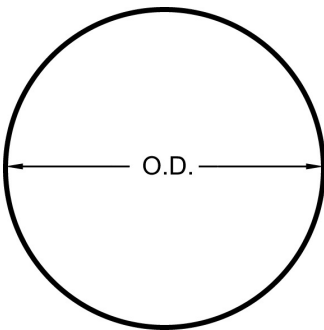

### Harvel® PVC Centerless Ground Bar - Gray

Pipe Size (inch)	P/L	Part No.	O.D. (inch)	Wt/Ft (lbs/ft)
¼	H33	<b>HROD0025PC1000</b>	0.250	0.029
⅜	H33	<b>HROD0038PC1000</b>	0.375	0.066
½	H33	<b>HROD0050PC1000</b>	0.500	0.117
⅝	H33	<b>HROD0063PC1000</b>	0.625	0.183
¾	H33	<b>HROD0075PC1000</b>	0.750	0.265
⅞	H33	<b>HROD0088PC1000</b>	0.875	0.358
1	H33	<b>HROD0100PC1000</b>	1.000	0.471
1 ⅛	H33	<b>HROD0113PC1000</b>	1.125	0.594
1 ¼	H33	<b>HROD0125PC1000</b>	1.250	0.736
1 ⅜	H33	<b>HROD0138PC1000</b>	1.375	0.891
1 ½	H33	<b>HROD0150PC1000</b>	1.500	1.060
1 ⅝	H33	<b>HROD0163PC1000</b>	1.625	0.244
1 ¾	H33	<b>HROD0175PC1000</b>	1.750	1.440
1 ⅞	H33	<b>HROD0188PC1000</b>	1.875	1.657
2	H33	<b>HROD0200PC1000</b>	2.000	1.890
2 ⅛	H33	<b>HROD0213PC0500</b>	2.125	2.128
2 ¼	H33	<b>HROD0225PC0500</b>	2.250	2.384
2 ⅜	H33	<b>HROD0238PC0500</b>	2.375	2.658
2 ½	H33	<b>HROD0250PC0500</b>	2.500	2.950

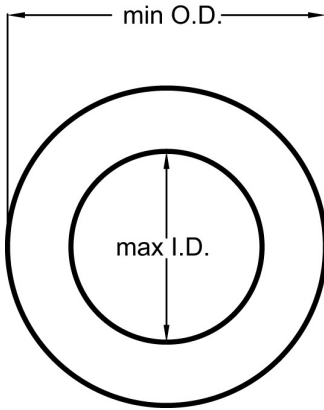

### Harvel® PVC Hollow Bar - Gray

Minimum O.D. (inch)	Maximum I.D. (inch)	P/L	Part No.	Wt/Ft (lbs/ft)
1.625	0.562	H35	HHOL1625PG1000	1.154
1.900	0.562	H35	HHOL1901PG1000	1.647
2.000	1.250	H35	HHOL2000PG1000	1.285
2.125	0.750	H35	HHOL2125PG1000	2.010
2.250	1.125	H35	HHOL2250PG1000	2.025
2.250	1.500	H35	HHOL2251PG1000	1.625
2.375	1.000	H35	HHOL2375PG1000	2.393
2.500	1.000	H35	HHOL2500PG1000	2.680
2.500	1.500	H35	HHOL2501PG1000	2.209
2.625	1.500	H35	HHOL2625PG1000	2.511
2.750	1.000	H35	HHOL2750PG1000	3.299
3.000	1.000	H35	HHOL3000PG1000	3.976
3.000	1.250	H35	HHOL3001PG1000	3.770
3.000	1.500	H35	HHOL3002PG1000	3.375
3.000	2.000	H35	HHOL3003PG1000	2.798
3.250	1.250	H35	HHOL3250PG1000	4.506
3.500	1.500	H35	HHOL3500PG1000	5.037
3.563	1.500	H35	HHOL3563PG1000	5.245
4.000	2.500	H35	HHOL4000PG1000	5.153
4.000	3.000	H35	HHOL4001PG1000	3.845
4.250	1.750	H35	HHOL4250PG1000	7.452
4.500	2.000	H35	HHOL4500PG1000	8.099
4.750	3.000	H35	HHOL4750PG1000	7.069
5.000	3.000	H35	HHOL5000PG1000	8.217
5.563	4.000	H35	HHOL5563PG0500	7.954
6.000	2.437	H35	HHOL6000PG0500	15.200
6.000	4.000	H35	HHOL6002PG0500	11.190
6.625	2.875	H35	HHOL6625PG0500	18.030
6.625	4.000	H35	HHOL6626PG0500	14.910
8.625	5.750	H35	HHOL8625PG0500	21.400

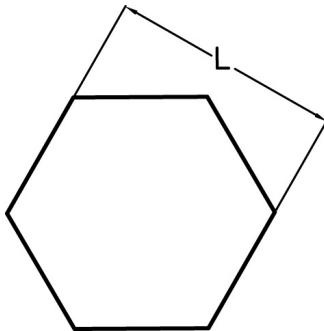

### Harvel® PVC Hexagonal Bar - Gray

Pipe Size (inch)	P/L	Part No.	L (inch)	Wt/Ft (lbs/ft)
3/16	H36	HHEX0044PG1000	0.438	0.108
1/2	H36	HHEX0050PG1000	0.500	0.142
3/16	H36	HHEX0056PG1000	0.563	0.180
5/8	H36	HHEX0063PG1000	0.625	0.222
3/4	H36	HHEX0075PG1000	0.750	0.320
13/16	H36	HHEX0081PG1000	0.813	0.375
7/8	H36	HHEX0088PG1000	0.875	0.435
1	H36	HHEX0100PG1000	1.000	0.569
1 1/8	H36	HHEX0113PG1000	1.125	0.721
1 1/4	H36	HHEX0125PG1000	1.250	0.890
1 3/8	H36	HHEX0138PG1000	1.375	1.080
1 1/2	H36	HHEX0150PG1000	1.500	1.283
1 3/4	H36	HHEX0175PG1000	1.750	1.746
2	H36	HHEX0200PG1000	0.125	2.280

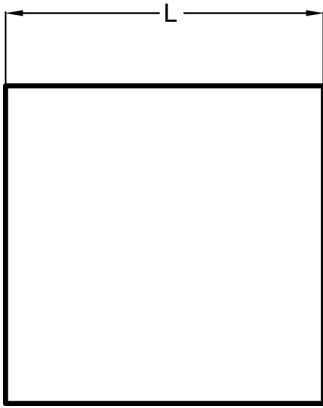

### Harvel® PVC Square Bar - Gray

Pipe Size (inch)	P/L	Part No.	L (inch)	Wt/Ft (lbs/ft)
½	H37	<b>HSQU0050PG1000</b>	0.500	0.157
⅝	H37	<b>HSQU0063PG1000</b>	0.625	0.238
¾	H37	<b>HSQU0075PG1000</b>	0.750	0.360
1	H37	<b>HSQU0100PG1000</b>	1.000	0.629
1 ¼	H37	<b>HSQU0125PG0800</b>	1.250	1.033
1 ½	H37	<b>HSQU0150PG0800</b>	1.500	1.464
2	H37	<b>HSQU0200PG0800</b>	2.000	2.452

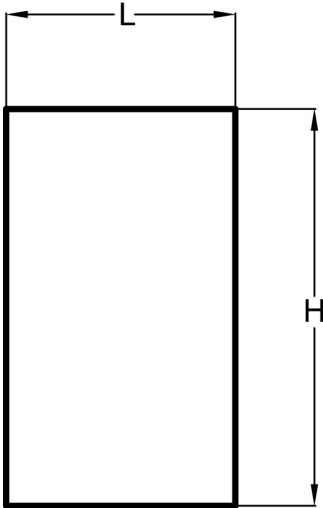

### Harvel® PVC Rectangular Bar - Gray

Pipe Size (inch)	P/L	Part No.	L (inch)	H (inch)	Wt/Ft (lbs/ft)
½ x ¾	H38	<b>HREC0050PG1000</b>	0.500	0.750	0.225

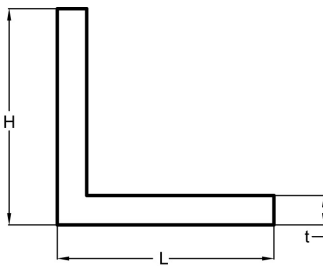

### Harvel® PVC Angle Bar - Gray

Size (inch)	P/L	Part No.	H (inch)	L (inch)	T (inch)	Wt/Ft (lbs/ft)
1 x 1 x ⅛	H31	<b>HANG0100PG1000</b>	1.00	1.00	0.125	0.141
1 ¼ x 1 ¼ x ⅜	H31	<b>HANG0125PG1000</b>	1.25	1.25	0.188	0.262
1 ½ x 1 ½ x ⅜	H31	<b>HANG0151PG1000</b>	1.50	1.50	0.188	0.316
1 ½ x 1 ½ x ¼	H31	<b>HANG0150PG1000</b>	1.50	1.50	0.250	0.415
2 x 2 x ¼	H31	<b>HANG0200PG1000</b>	2.00	2.00	0.250	0.563

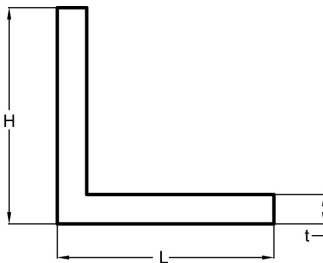

### Harvel® PVC Angle Bar - White

Size (inch)	P/L	Part No.	H (inch)	L (inch)	T (inch)	lbs per 100ft. (lb)	Wt/Ft (lbs/ft)
1 x 1 x ⅛	H31	<b>HANG0100PW1000</b>	1.00	1.00	0.125	14.10	0.141
1 ¼ x 1 ¼ x ⅜	H31	<b>HANG0125PW1000</b>	1.25	1.25	0.188	26.20	0.262
1 ½ x 1 ½ x ⅜	H31	<b>HANG0151PW1000</b>	1.50	1.50	0.188	31.60	0.316
2 x 2 x ¼	H31	<b>HANG0200PW1000</b>	2.00	2.00	0.250	56.30	0.563

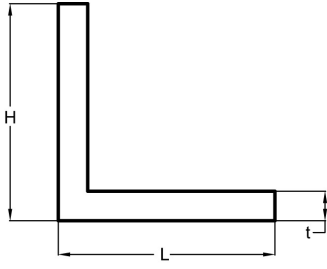

**Harvel® PVC Angle Bar - Clear**

Size (inch)	P/L	Part No.	H (inch)	L (inch)	T (inch)	Wt/Ft (lbs/ft)
1 x 1 x 1 1/8	H40	<b>HANG0100PL1000</b>	1.00	1.00	0.125	0.141
1 1/4 x 1 1/4 x 3/16	H40	<b>HANG0125PL1000</b>	1.25	1.25	0.188	0.262
1 1/2 x 1 1/2 x 3/16	H40	<b>HANG0150PL1000</b>	1.50	1.50	0.188	0.316
1 1/2 x 1 1/2 x 1/4	H40	<b>HANG0151PL1000</b>	1.50	1.50	0.250	0.415
2 x 2 x 1/4	H40	<b>HANG0200PL1000</b>	2.00	2.00	0.250	0.563

# CPVC Extruded Shapes and Rods

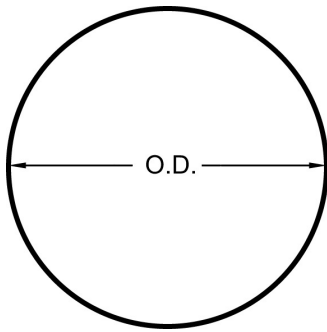

## Harvel® CORZAN® CPVC Solid Round Bar - Gray

Pipe Size (inch)	P/L	Part No.	O.D. (inch)	Wt/Ft (lbs/ft)
¼	H43	<b>HROD0025CS1000</b>	0.250	0.032
⅜	H43	<b>HROD0038CS1000</b>	0.375	0.074
½	H43	<b>HROD0050CS1000</b>	0.500	0.131
¾	H43	<b>HROD0075CS1000</b>	0.750	0.296
1	H43	<b>HROD0100CS1000</b>	1.000	0.526
1 ¼	H43	<b>HROD0125CS1000</b>	1.250	0.821
1 ⅝	H43	<b>HROD0138CS1000</b>	1.375	0.994
1 ½	H43	<b>HROD0150CS1000</b>	1.500	1.183
1 ¾	H43	<b>HROD0175CS1000</b>	1.750	1.618
2	H43	<b>HROD0200CS0500</b>	2.000	2.109
2 ½	H43	<b>HROD0250CS0500</b>	2.500	3.375
3	H43	<b>HROD0300CS0500</b>	3.000	4.595
3 ½	H43	<b>HROD0350CS0500</b>	3.500	6.439
4	H43	<b>HROD0400CS0500</b>	4.000	8.460
5	H43	<b>HROD0500CS0500</b>	5.000	13.950
6	H43	<b>HROD0600CS0500</b>	6.000	20.395

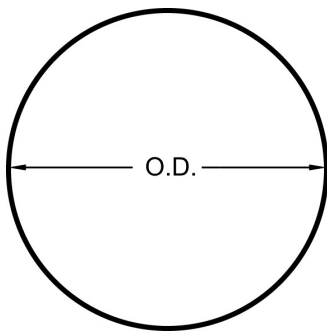

## Harvel® CORZAN® CPVC Centerless Ground Bar - Gray

Pipe Size (inch)	P/L	Part No.	O.D. (inch)	Wt/Ft (lbs/ft)
¼	H44	<b>HROD0025CC1000</b>	0.250	0.032
⅜	H44	<b>HROD0038CC1000</b>	0.375	0.074
½	H44	<b>HROD0050CC1000</b>	0.500	0.131
¾	H44	<b>HROD0075CC1000</b>	0.750	0.296
1	H44	<b>HROD0100CC1000</b>	1.000	0.526
1 ¼	H44	<b>HROD0125CC1000</b>	1.250	0.821
1 ⅝	H44	<b>HROD0138CC1000</b>	1.375	0.994
1 ½	H44	<b>HROD0150CC1000</b>	1.500	1.183
1 ¾	H44	<b>HROD0175CC1000</b>	1.750	1.618
2	H44	<b>HROD0200CC0500</b>	2.000	2.109
2 ½	H44	<b>HROD0250CC0500</b>	2.500	3.375

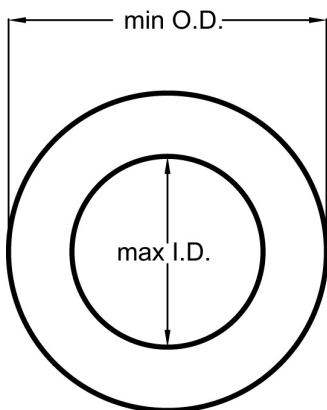

## Harvel® CORZAN® CPVC Hollow Bar - Gray

Minimum O.D. (inch)	Maximum I.D. (inch)	P/L	Part No.	Wt/Ft (lbs/ft)
1.625	0.562	H45	<b>HHOL1625CG1000</b>	1.288
2.125	0.750	H45	<b>HHOL2125CG1000</b>	2.243
2.250	1.125	H45	<b>HHOL2250CG1000</b>	2.260
1.375	1.000	H45	<b>HHOL2375CG1000</b>	2.671
2.625	1.500	H45	<b>HHOL2625CG1000</b>	2.802
2.750	1.000	H45	<b>HHOL2750CG1000</b>	3.682
2.875	1.500	H45	<b>HHOL2875CG1000</b>	3.525
3.000	1.250	H45	<b>HHOL3001CG1000</b>	4.207
3.563	1.500	H45	<b>HHOL3563CG1000</b>	5.853
4.000	2.500	H45	<b>HHOL4000CG1000</b>	5.751
4.250	1.750	H45	<b>HHOL4250CG1000</b>	8.316
4.750	3.000	H45	<b>HHOL4750CG1000</b>	7.889
5.000	3.000	H45	<b>HHOL5000CG1000</b>	9.170
6.625	2.875	H45	<b>HHOL6625CG0500</b>	20.121
6.625	4.000	H45	<b>HHOL6626CG0500</b>	16.640



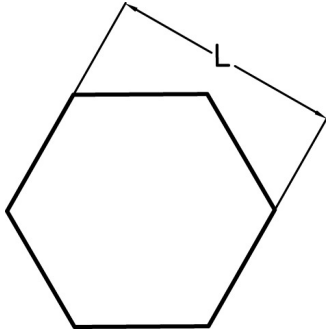

### Harvel® CORZAN® CPVC Hexagonal Bar - Gray

Pipe Size (inch)	P/L	Part No.	L (inch)	Wt/Ft (lbs/ft)
7/16	H46	<b>HHEX0044CG1000</b>	0.438	0.121
1/2	H46	<b>HHEX0050CG1000</b>	0.500	0.159
9/16	H46	<b>HHEX0056CG1000</b>	0.563	0.202
5/8	H46	<b>HHEX0063CG1000</b>	0.625	0.249
3/4	H46	<b>HHEX0075CG1000</b>	0.750	0.359
13/16	H46	<b>HHEX0081CG1000</b>	0.813	0.421
7/8	H46	<b>HHEX0088CG1000</b>	0.875	0.489
1	H46	<b>HHEX0100CG1000</b>	1.000	0.639
1 1/8	H46	<b>HHEX0113CG1000</b>	1.125	0.810
1 1/4	H46	<b>HHEX0125CG1000</b>	1.250	0.999
1 3/8	H46	<b>HHEX0138CG1000</b>	1.375	1.213
1 1/2	H46	<b>HHEX0150CG1000</b>	1.500	1.441
2	H46	<b>HHEX0200CG1000</b>	2.000	2.560

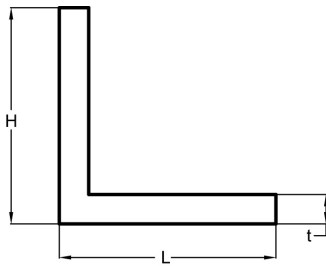

### Harvel® CORZAN® CPVC Angle Bar - Gray

Size (inch)	P/L	Part No.	H (inch)	L (inch)	T (inch)	Wt/Ft (lbs/ft)
1 x 1 x 1 1/8	H42	<b>HANG0100CG1000</b>	1.00	1.00	0.125	0.180
1 1/4 x 1 1/4 x 3/16	H42	<b>HANG0125CG1000</b>	1.25	1.25	0.188	0.325
1 1/2 x 1 1/2 x 1/4	H42	<b>HANG0151CG1000</b>	1.50	1.50	0.250	0.395
2 x 2 x 1/4	H42	<b>HANG0200CG1000</b>	2.00	2.00	0.250	0.645



## Section 6

# Joining Accessories

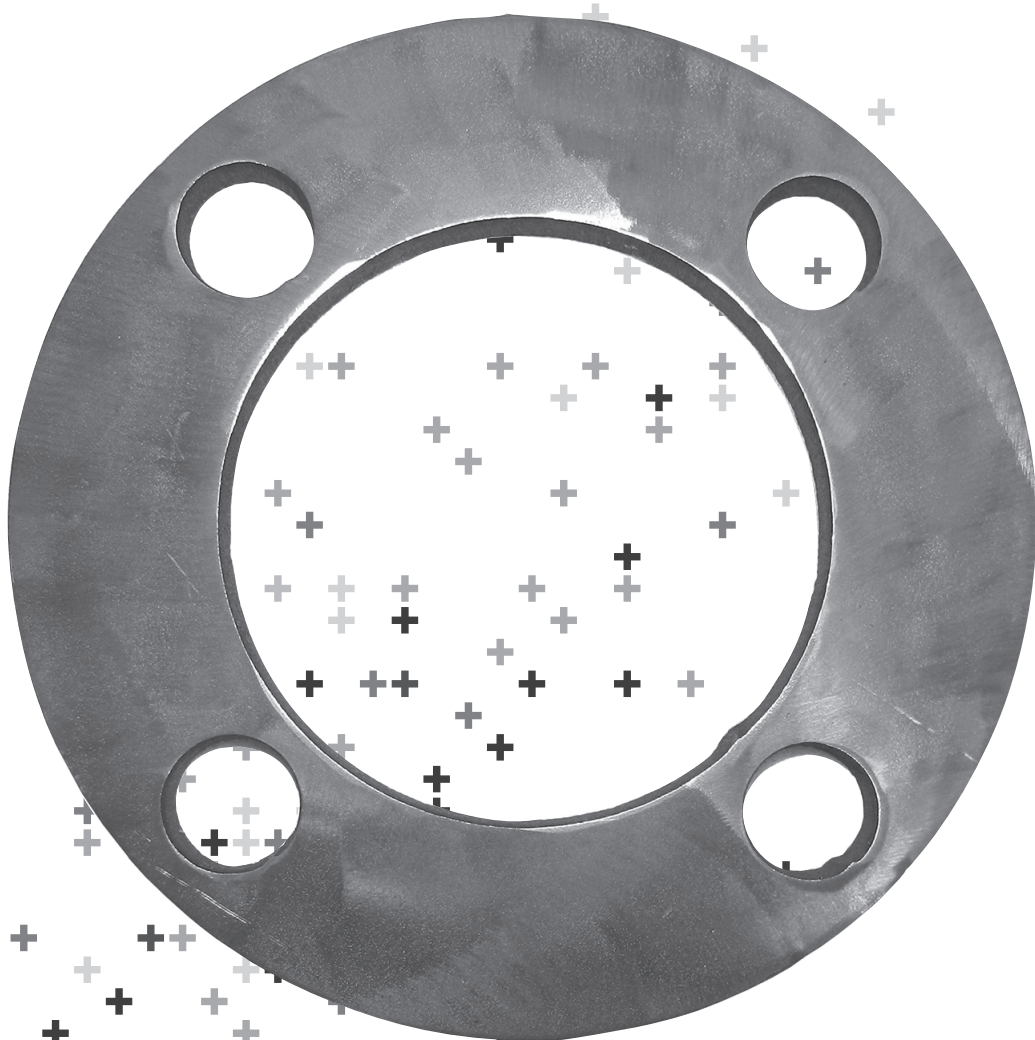

# Joining Accessories



**EPDM Full Face Flange Gasket - 150# ANSI Bolt Pattern**

Size	P/L	Part No.	Pack Qty
1/2	607	37X002001	5
3/4	607	37X002002	5
1	607	37X002003	5
1 1/4	607	37X002004	5
1 1/2	607	37X002005	5
2	607	37X002006	5
2 1/2	607	37X002007	5
3	607	37X002008	5
4	607	37X002009	5
5	607	37X002019	1
6	607	37X002010	2
8	607	37X002011	2
10	607	37X002012	2
12	607	37X002013	2
14	607	37X002014	1
16	607	37X002015	1
18	607	37X002016	1
20	607	37X002017	1
24	607	37X002018	1



**FKM Full Face Flange Gasket - 150# ANSI Bolt Pattern**

Size	P/L	Part No.	Pack Qty
1/2	607	37X002110	5
3/4	607	37X002111	5
1	607	37X002112	5
1 1/4	607	37X002113	5
1 1/2	607	37X002114	5
2	607	37X002115	5
2 1/2	607	37X002116	5
3	607	37X002117	5
4	607	37X002118	5
5	607	37X002128	1
6	607	37X002119	2
8	607	37X002120	2
10	607	37X002121	2
12	607	37X002122	2
14	607	37X002123	1
16	607	37X002124	1
18	607	37X002125	1
20	607	37X002126	1
24	607	37X002127	1



**EPDM Stress Saver XP Flange Gasket - 150# ANSI Bolt Pattern**

Size	P/L	Part No.	Pack Qty
1/2	607	37X002200	1
3/4	607	37X002201	1
1	607	37X002202	1
1 1/4	607	37X002203	1
1 1/2	607	37X002204	1
2	607	37X002205	1
2 1/2	607	37X002206	1
3	607	37X002207	1
4	607	37X002208	1

table continued on the next page

Size	P/L	Part No.	Pack Qty
6	607	37X002209	1
8	607	37X002210	1
10	607	37X002211	1
12	607	37X002212	1

### EPDM Full Face Flange Gasket - 300# ANSI Bolt Pattern



Size (inch)	P/L	Part No.	Pack Qty
½	607	37X002021	5
¾	607	37X002022	5
1	607	37X002023	5
1 ¼	607	37X002024	5
1 ½	607	37X002025	5
2	607	37X002026	5
2 ½	607	37X002027	5
3	607	37X002028	5
4	607	37X002029	5
6	607	37X002031	2
8	607	37X002032	2
10	607	37X002033	2
12	607	37X002034	2

### 304SS Flange Backing Rings



Size	P/L	Part No.	Pack Qty
1/2	607	37X003308	1
3/4	607	37X003309	1
1	607	37X003310	1
1 1/4	607	37X003337	1
1 1/2	607	37X003311	1
2	607	37X003312	1
2 1/2	607	37X003338	1
3	607	37X003313	1
4	607	37X003334	1
6	607	37X003335	1
8	607	37X003336	1
10	607	37X003339	1
12	607	37X003340	1

### 316SS Flange Bolt Kits - 150#



- The kits will include the appropriate number of UNC bolts, SAE washers, and nuts prelubricated prior to packaging.

P/L	Part No.	Flange Size (inch)	Bolts Per Kit	Bolt Length (inch)	Bolt Size (inch)
607	37Z000061	½	4	2.50	½
607	37Z000062	¾	4	2.50	½
607	37Z000063	1	4	2.75	½
607	37Z000064	1 ¼	4	2.75	½
607	37Z000065	1 ½	4	3.25	½
607	37Z000066	2	4	3.50	¾
607	37Z000067	2 ½	4	4.00	¾
607	37Z000068	3	4	4.00	¾
607	37Z000069	4	8	4.25	¾
607	37Z000070	6	8	4.50	¾
607	37Z000071	8	8	6.00	¾
607	37Z000072	10	12	6.00	¾
607	37Z000073	12	12	6.00	¾

table continued on the next page

P/L	Part No.	Flange Size (inch)	Bolts Per Kit	Bolt Length (inch)	Bolt Size (inch)
607	<b>37Z000074</b>	14	12	5.00	1
607	<b>37Z000075</b>	16	16	5.50	1
607	<b>37Z000076</b>	18	16	5.50	1 1/8
607	<b>37Z000077</b>	20	20	6.00	1 1/8
607	<b>37Z000078</b>	24	20	6.50	1 1/4



### PPC Plastic Pipe Cutter

- For cutting plastic pipes 1/2" - 6"

Size (inch)	P/L	Part No.	Max. Wall (inch)
1/2 - 2	607	<b>790 109 001</b>	0.28
1 1/2 - 4	607	<b>790 109 002</b>	0.50
4 - 6	607	<b>790 109 003</b>	0.75



### KS 355 Plastic Pipe Cutter

- For 6" - 14" diameter pipe with wall thickness 5/16" - 1-1/2"
- Unique clamping mechanism. No additional belts, chains or reduction inserts needed.
- Supplied with transport box: Dimensions 27.50" x 13.75" x 19.70"; Weight 34.5 lbs.

Size (inch)	P/L	Part No.	Power
6 - 14	607	<b>790 202 001</b>	1750 W; 230 V; 50/60 Hz

### Chamfering Tools

- Chamfering tool with 15° bevel



150 109 104

Size (inch)	P/L	Part No.
1 1/4 - 4	607	<b>150 109 104</b>
2 - 14	607	<b>790 309 004</b>





Section 7

# Metric PVC Piping System

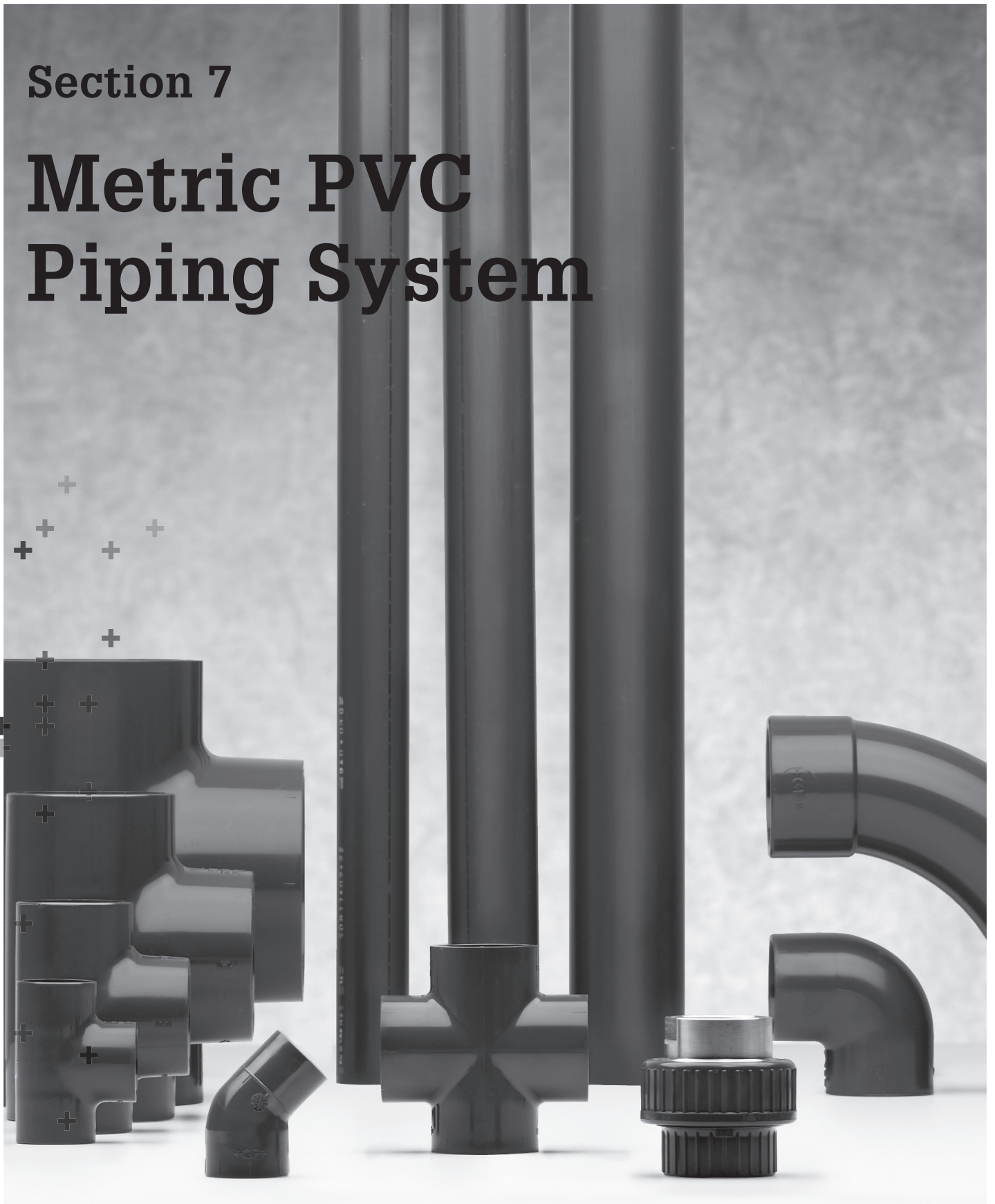

## Table of contents

Page



Pipes

227



Fittings

228



Unions

234



Valves

235



Flange Adapters

242

# Pipes

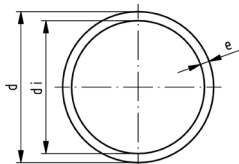

## Pipe PVC grey SDR13.6/PN16/S6.3

### Model:

- Material: PVC
- Dimension: DIN 8061/62
- Color: dark grey RAL 7011
- Supplied in 5m lengths
- **Note 1:** DIBT Z-40.23-1 approval
- Attention: Pressure ratings refer to operating temperatures at 20°C.

d (mm)	PN (bar)	Part No.	weight (kg/m)	e (mm)	di (mm)
12	16	161 017 104	0.062	1.1	9.8
16	16	161 017 105	0.091	1.2	13.6
20	16	161 017 106	0.139	1.5	17.0
25	16	161 017 107	0.215	1.9	21.2
32	16	161 017 108	0.347	2.4	27.2
40	16	161 017 109	0.533	3.0	34.0
50	16	161 017 110	0.821	3.7	42.6
63	16	161 017 111	1.310	4.7	53.6
75	16	161 017 112	1.850	5.6	58.2
90	16	161 017 113	2.640	6.7	76.6
110	16	161 017 114	3.910	8.1	93.8
125	16	161 017 115	5.040	9.2	106.6
140	16	161 017 116	6.030	10.3	119.4
160	16	161 017 117	8.230	11.8	136.4

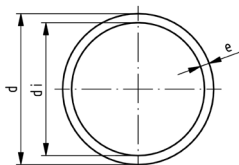

## Pipe PVC grey High-Performance SDR9

### Model:

- SDR 9 / High Performance
- Material: PVC
- Dimension: DIN 8061/62
- Color: dark grey RAL 7011
- Supplied in 5m lengths
- **Note 1:** DIBT Z-40.23-1 approval
- Attention: Pressure ratings refer to operating temperatures at 20°C.

d (mm)	PN (bar)	Part No.	weight (kg/m)	e (mm)	di (mm)
6	16	161 017 126	0.025	1.0	4.0
8	16	161 017 127	0.035	1.0	6.0
10	16	161 017 128	0.054	1.2	7.6

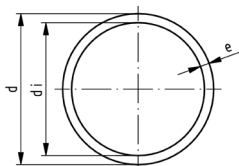

## Pipe PVC grey SDR21/PN10/S10

### Model:

- Material: PVC
- Dimension: DIN 8061/62
- Color: dark grey RAL 7011
- Supplied in 5m lengths
- **Note 1:** DIBT Z-40.23-1 approval
- Attention: Pressure ratings refer to operating temperatures at 20°C.

d (mm)	PN (bar)	Part No.	weight (kg/m)	e (mm)	di (mm)
25	10	161 017 082	0.177	1.5	22.0
32	10	161 017 083	0.280	1.9	28.4
40	10	161 017 084	0.355	1.9	36.2
50	10	161 017 085	0.560	2.4	45.2

table continued on the next page

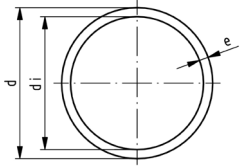

d (mm)	PN (bar)	Part No.	weight (kg/m)	e (mm)	di (mm)
63	10	<b>161 017 086</b>	0.866	3.0	57.0
75	10	<b>161 017 087</b>	1.240	3.6	67.8
90	10	<b>161 017 088</b>	1.770	4.3	81.4
110	10	<b>161 017 089</b>	2.650	5.3	99.4
125	10	<b>161 017 090</b>	3.390	6.0	113.0
140	10	<b>161 017 091</b>	4.240	6.7	126.6
160	10	<b>161 017 092</b>	5.550	7.7	144.7
180	10	<b>161 017 093</b>	6.970	8.6	162.8
200	10	<b>161 017 094</b>	8.640	9.6	180.8
225	10	<b>161 017 095</b>	10.900	10.8	203.4

## Fittings

### Pipe Fittings for solvent cement jointing



#### Bend 90° PVC metric

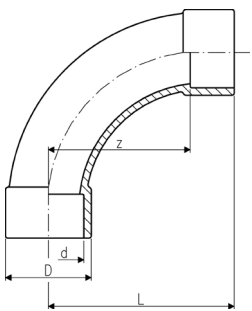

d (mm)	PN (bar)	Part No.	SP weight (kg)	z (mm)	D (mm)	L (mm)	
20	16	<b>721 000 106</b>	10	0.029	40	27	56
25	16	<b>721 000 107</b>	10	0.049	50	33	69
32	16	<b>721 000 108</b>	10	0.074	64	38	86
40	16	<b>721 000 109</b>	30	0.121	80	47	106
50	16	<b>721 000 110</b>	5	0.298	100	61	131
63	16	<b>721 000 111</b>	6	0.516	126	76	164
75	16	<b>721 000 112</b>	5	0.798	150	90	194
90	16	<b>721 000 113</b>	5	1.373	180	108	231
110	16	<b>721 000 114</b>	5	2.699	220	137	281
140	16	<b>721 000 116</b>	2	5.204	280	168	356
160	16	<b>721 000 117</b>	1	8.298	320	192	406



#### Elbow 90° PVC metric

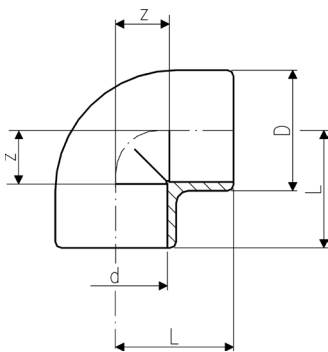

d (mm)	PN (bar)	Part No.	SP weight (kg)	z (mm)	D (mm)	L (mm)	
6	16	<b>721 100 101</b>	10	0.004	4	11	16
8	16	<b>721 100 102</b>	10	0.004	5	13	17
10	16	<b>721 100 103</b>	10	0.004	6	14	18
12	16	<b>721 100 104</b>	10	0.006	7	17	19
16	16	<b>721 100 105</b>	10	0.007	9	21	23
20	16	<b>721 100 106</b>	10	0.012	11	25	27
25	16	<b>721 100 107</b>	10	0.024	14	32	33
32	16	<b>721 100 108</b>	10	0.043	17	40	39
40	16	<b>721 100 109</b>	10	0.062	23	47	49
50	16	<b>721 100 110</b>	10	0.107	26	59	57
63	16	<b>721 100 111</b>	10	0.205	33	73	71
75	16	<b>721 100 112</b>	5	0.336	40	87	83
90	16	<b>721 100 113</b>	5	0.576	46	105	97
110	16	<b>721 100 114</b>	4	1.009	55	128	116
160	16	<b>721 100 117</b>	2	2.873	80	185	166
200	10	<b>721 100 119</b>	1	4.446	101	225	207
225	10	<b>721 100 120</b>	1	5.989	114	252	233

### Elbow 45° PVC metric

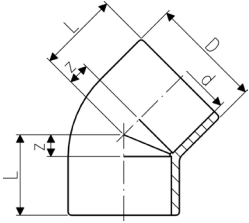

d (mm)	PN (bar)	Part No.	SP	weight (kg)	z (mm)	D (mm)	L (mm)
16	16	721 150 105	10	0.008	5	21	19
20	16	721 150 106	10	0.011	5	25	21
25	16	721 150 107	10	0.017	6	31	25
32	16	721 150 108	10	0.021	8	38	30
40	16	721 150 109	10	0.048	10	47	36
50	16	721 150 110	5	0.086	12	59	43
63	16	721 150 111	5	0.160	14	73	52
75	16	721 150 112	5	0.253	17	87	61
90	16	721 150 113	4	0.430	20	105	71
110	16	721 150 114	4	0.750	25	127	86
160	16	721 150 117	4	2.280	36	185	122
200	10	721 150 119	2	3.288	43	225	149
225	10	721 150 120	1	4.191	49	250	168

### Tee 90° equal PVC metric

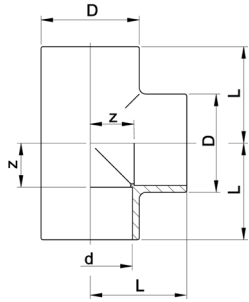

d (mm)	PN (bar)	Part No.	SP	weight (kg)	D (mm)	L (mm)	z (mm)
6	16	721 200 101	10	0.004	11	16	4
8	16	721 200 102	10	0.008	13	17	5
10	16	721 200 103	10	0.008	16	18	6
12	16	721 200 104	10	0.011	19	19	7
16	16	721 200 105	10	0.011	21	23	9
20	16	721 200 106	10	0.019	25	27	11
25	16	721 200 107	10	0.029	31	33	14
32	16	721 200 108	10	0.055	38	39	17
40	16	721 200 109	10	0.100	48	49	23
50	16	721 200 110	10	0.156	58	57	26
63	16	721 200 111	10	0.291	73	71	33
75	16	721 200 112	5	0.476	87	83	39
90	16	721 200 113	4	0.824	105	97	46
110	16	721 200 114	6	1.411	127	116	55
125	16	721 200 115	2	2.521	151	135	66
140	16	721 200 116	1	3.410	169	147	71
160	16	721 200 117	1	4.982	193	167	81
200	10	721 200 119	1	5.868	225	207	101
225	10	721 200 120	1	9.268	256	233	114

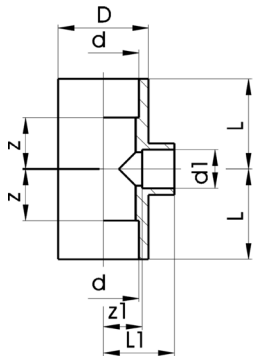

### Tee 90° reducing PVC metric

d (mm)	d1 (mm)	PN (bar)	Part No.	SP weight (kg)	z (mm)	z1 (mm)	D (mm)	L (mm)	L1 (mm)
25	20	16	721 200 134	10	0.038	14	14	33	30
32	20	16	721 200 141	10	0.061	17	17	41	33
32	25	16	721 200 138	10	0.063	17	17	41	36
40	20	16	721 200 155	10	0.103	23	23	50	39
40	25	16	721 200 151	10	0.107	23	23	50	42
40	32	16	721 200 147	10	0.109	23	23	50	45
50	20	16	721 200 009	5	0.179	28	28	62	44
50	25	16	721 200 010	5	0.183	28	28	62	47
50	32	16	721 200 164	5	0.189	28	28	62	50
50	40	16	721 200 161	5	0.208	28	28	62	54
63	25	16	721 200 011	10	0.332	35	34	77	53
63	32	16	721 200 178	5	0.336	35	34	77	56
63	40	16	721 200 174	5	0.347	35	34	77	60
63	50	16	721 200 170	5	0.354	35	34	77	65
75	32	16	721 200 181	9	0.535	40	41	92	63
75	40	16	721 200 182	9	0.555	40	41	92	67
75	50	16	721 200 183	8	0.541	40	41	92	72
75	63	16	721 200 184	8	0.570	40	41	92	79
90	32	16	721 200 142	6	0.855	46	55	110	77
90	50	16	721 200 144	6	0.907	46	55	110	86
90	63	16	721 200 145	5	0.931	46	55	110	93
90	75	16	721 200 146	5	0.959	46	55	110	99
110	32	16	721 200 135	3	1.441	56	67	133	89
110	50	16	721 200 136	3	1.471	56	67	133	98
110	63	16	721 200 132	3	1.522	56	65	133	103
110	75	16	721 200 133	3	1.543	56	65	133	109
140	110	16	721 200 150	1	3.422	72	74	172	148
160	110	16	721 200 152	1	4.305	81	81	192	142
200	110	10	721 200 153	1	8.782	107	131	232	192
200	160	10	721 200 154	1	8.036	107	106	232	192
225	110	10	721 200 156	1	10.619	120	143	257	204

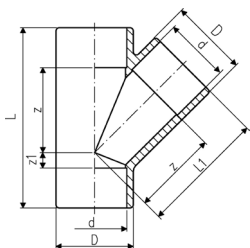

### Tee 45° PVC metric

d (mm)	PN (bar)	Part No.	SP weight (kg)	z (mm)	z1 (mm)	D (mm)	L (mm)	L1 (mm)	
10	10	721 250 103	100	0.013	18	4	16	46	30
12	10	721 250 104	100	0.014	21	4	18	49	33
16	10	721 250 105	100	0.022	25	5	23	58	39
20	10	721 250 106	10	0.035	30	6	28	68	46
25	10	721 250 107	10	0.056	36	9	33	83	55
32	10	721 250 108	10	0.096	45	10	41	99	67
40	10	721 250 109	10	0.159	56	10	50	118	82
50	10	721 250 110	8	0.265	66	12	60	140	97
63	10	721 250 111	5	0.439	85	14	74	175	123
75	6	721 250 112	5	0.816	101	18	91	207	145
90	6	721 250 113	1	1.275	122	20	107	245	173
110	6	721 250 114	3	2.579	149	27	134	298	210
160	6	721 250 117	1	7.187	213	41	190	428	300
200	6	721 250 119	1	12.314	265	48	232	527	372
225	6	721 250 120	1	15.735	296	54	260	590	416



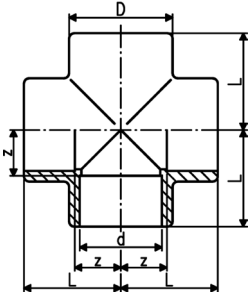

### Cross PVC metric

d (mm)	PN (bar)	Part No.	SP	weight (kg)	D (mm)	L (mm)	z (mm)
10	16	721 300 103	100	0.009	16	19	7
12	16	721 300 104	100	0.010	18	20	8
16	16	721 300 105	100	0.020	23	24	10
20	16	721 300 106	10	0.036	29	27	11
25	16	721 300 107	10	0.054	35	33	14
32	16	721 300 108	10	0.092	43	39	17
40	16	721 300 109	5	0.155	52	49	23
50	16	721 300 110	5	0.259	63	59	28
63	16	721 300 111	5	0.482	79	72	34
75	10	721 300 112	3	0.725	92	83	40
90	10	721 300 113	4	1.221	106	97	48
110	10	721 300 114	4	2.111	128	117	59

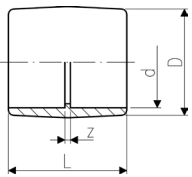

### Socket equal PVC metric

<sup>1</sup> Socket d355 and d400 fabricated from pipe

d (mm)	PN (bar)	Part No.	SP	weight (kg)	z (mm)	D (mm)	L (mm)
6	16	721 910 101	10	0.004	3	12	27
8	16	721 910 102	10	0.005	3	14	27
10	16	721 910 103	1	0.004	3	16	27
12	16	721 910 104	1	0.004	3	19	27
16	16	721 910 105	10	0.006	3	22	31
20	16	721 910 106	10	0.011	3	26	35
25	16	721 910 107	10	0.015	3	32	41
32	16	721 910 108	10	0.026	3	39	47
40	16	721 910 109	10	0.045	3	48	55
50	16	721 910 110	10	0.064	3	58	65
63	16	721 910 111	10	0.118	3	73	79
75	16	721 910 112	10	0.188	4	87	92
90	16	721 910 113	10	0.328	5	105	107
110	16	721 910 114	6	0.554	6	128	128
160	16	721 910 117	2	1.540	8	183	180
200	10	721 910 119	1	2.559	9	221	221
225	10	721 910 120	2	3.519	10	253	248

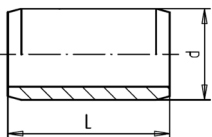
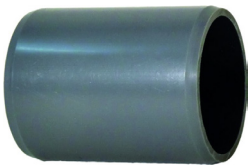

### Barrel nipple PVC metric

Model:

d (mm)	PN (bar)	Part No.	weight (kg)	L (mm)
16	16	721 900 905	0.002	28
20	16	721 900 906	0.005	32
25	16	721 900 907	0.009	38
32	16	721 900 908	0.015	44
40	16	721 900 909	0.027	52
50	16	721 900 910	0.048	62
63	16	721 900 911	0.092	76
75	16	721 900 912	0.156	88
90	16	721 900 913	0.260	102
110	16	721 900 914	0.455	122
125	16	721 900 915	0.673	138

table continued on the next page

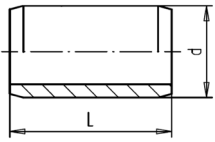

d (mm)	PN (bar)	Part No.	weight (kg)	L (mm)
140	16	721 900 916	0.932	152
160	16	721 900 917	1.565	192
200	10	721 900 919	1.779	212
225	10	721 900 920	2.566	238

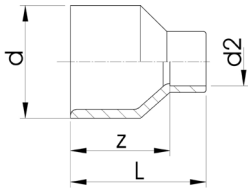

### Reducing bush long PVC metric

#### Model:

- With solvent cement spigot and socket metric

d (mm)	d2 (mm)	PN (bar)	Part No.	SP	weight (kg)	z (mm)	L (mm)
8	6	16	721 910 323	10	0.003	15	27
10	6	16	721 910 326	10	0.003	15	27
10	8	16	721 910 325	10	0.003	15	27
20	16	16	721 910 334	10	0.009	21	35
25	20	16	721 910 337	10	0.014	25	41
32	25	16	721 910 341	10	0.024	30	49
40	32	16	721 910 346	10	0.044	36	58
50	40	16	721 910 352	10	0.074	44	70
63	50	16	721 910 358	5	0.148	54	85
75	63	16	721 910 364	5	0.211	62	100
90	75	16	721 910 370	8	0.335	74	118

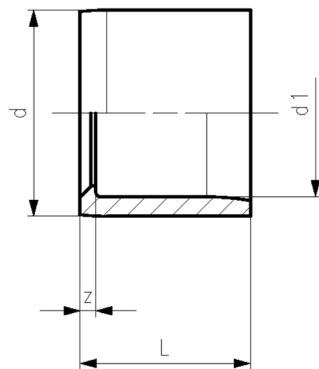
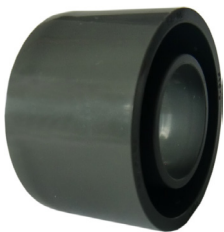

### Reducing bush short PVC metric

#### Model:

- With solvent cement spigot and socket metric

d (mm)	d1 (mm)	PN (bar)	Part No.	SP	weight (kg)	z (mm)	L (mm)
12	8	16	721 900 329	1	0.002	2	14
16	12	16	721 900 331	10	0.002	2	14
20	16	16	721 900 334	10	0.002	2	16
25	20	16	721 900 337	10	0.004	3	19
32	20	16	721 900 342	10	0.014	6	22
32	25	16	721 900 341	10	0.009	3	22
40	20	16	721 900 348	10	0.021	10	26
40	25	16	721 900 347	10	0.021	7	26
40	32	16	721 900 346	10	0.016	4	26
50	20	16	721 900 355	10	0.037	15	31
50	25	16	721 900 354	10	0.034	12	31
50	32	16	721 900 353	10	0.036	9	31
50	40	16	721 900 352	10	0.030	5	31
63	32	16	721 900 360	10	0.064	16	38
63	40	16	721 900 359	10	0.067	12	38
63	50	16	721 900 358	10	0.058	7	38
75	50	16	721 900 365	10	0.109	13	44
75	63	16	721 900 364	10	0.078	6	44
90	50	16	721 900 372	10	0.181	20	51
90	63	16	721 900 371	12	0.183	13	51
90	75	16	721 900 370	10	0.135	7	51
110	50	16	721 900 379	5	0.316	30	61
110	63	16	721 900 378	5	0.308	23	61
110	75	16	721 900 377	20	0.295	17	61
110	90	16	721 900 376	5	0.259	10	61
160	90	16	721 900 391	6	0.751	35	86
160	110	16	721 900 390	6	0.883	25	86
200	110	10	721 900 393	3	1.985	45	108

table continued on the next page

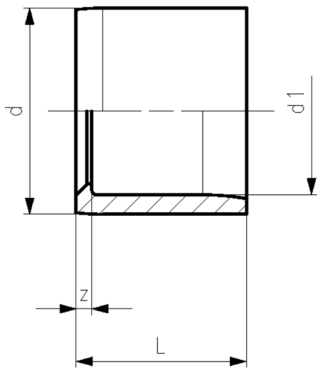

d (mm)	d1 (mm)	PN (bar)	Part No.	SP weight (kg)	z (mm)	L (mm)
200	160	10	721 900 392	2	1.085	20 108
225	110	10	721 900 397	4	2.544	57 120
225	160	10	721 900 396	2	2.199	31 119
225	200	10	721 900 181	9	1.360	13 119

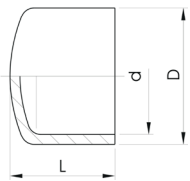

### Cap PVC metric

d (mm)	PN (bar)	Part No.	SP weight (kg)	D (mm)	L (mm)
12	16	721 960 104	10 0.004	19	15
16	16	721 960 105	10 0.005	23	21
20	16	721 960 106	10 0.008	27	24
25	16	721 960 107	10 0.013	33	28
32	16	721 960 108	10 0.020	40	32
40	16	721 960 109	10 0.029	47	37
50	16	721 960 110	10 0.051	58	45
63	16	721 960 111	5 0.095	73	56
75	16	721 960 112	5 0.152	87	65
90	16	721 960 113	5 0.269	105	77
110	16	721 960 114	12 0.457	128	94
160	10	721 960 117	2 1.534	188	130

## Adapter Fittings

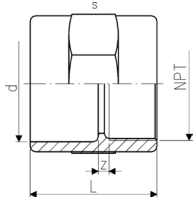

### Adapter socket PVC metric NPT

#### Model:

- With solvent cement socket metric and NPT (ASTM) taper female thread
- Connection to plastic thread only
- Install with low mechanical stress and avoid large cyclic temperature changes
- Do not use thread sealing pastes that are harmful to PVC

d (mm)	PN (bar)	Part No.	SP weight (kg)	z (mm)	L (mm)	s (mm)
20	10	721 914 206	10 0.021	5	35	32
25	10	721 914 207	10 0.028	6	40	36
32	10	721 914 208	10 0.049	6	45	46
40	10	721 914 209	10 0.076	6	51	55
50	10	721 914 210	10 0.110	10	59	65
63	10	721 914 211	5 0.175	10	69	80

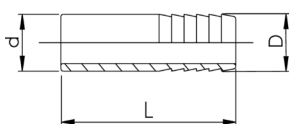

### Hose connector PVC metric

#### Model:

- With solvent cement spigot metric and parallel hose connection

d (mm)	PN (bar)	Part No.	SP weight (kg)	D (mm)	L (mm)
10	16	721 960 403	10 0.002	8	47
12	16	721 960 404	10 0.003	12	51
16	16	721 960 405	10 0.008	16	57
20	16	721 960 406	10 0.016	20	73

table continued on the next page

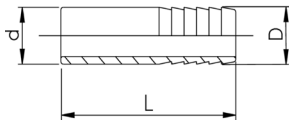

d (mm)	PN (bar)	Part No.	SP weight (kg)	D (mm)	L (mm)	
25	16	721 960 407	10	0.021	25	79
32	16	721 960 408	10	0.035	30	89
32	16	721 960 508	10	0.035	32	89
40	16	721 960 409	5	0.060	40	100
50	16	721 960 410	5	0.112	50	105
63	16	721 960 411	5	0.180	60	120

## Unions Adaptor Unions



### Adapter union PVC metric NPT

#### Model:

- Union End: Taper female thread NPT (ASTM)
- Union Bush: Solvent socket metric
- Gasket: O-ring EPDM code no. 748 410 005-011
- Gasket: O-ring FKM code no. 749 410 005-011 (to be ordered separately)
- Connection to plastic thread only
- Do not use thread sealing pastes that are harmful to PVC

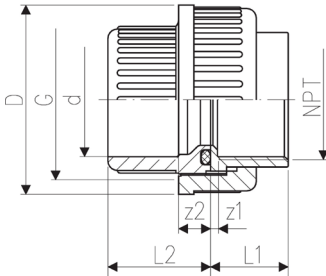

d (mm)	PN (bar)	EPDM Part No.	SP weight (kg)	G (inch)	z1 (mm)	z2 (mm)	D (mm)	L1 (mm)	L2 (mm)	
16	10	721 514 205	10	0.026	¾	4	10	35	17	24
20	10	721 514 206	10	0.042	1	2	10	43	19	26
25	10	721 514 207	10	0.068	1 ¼	4	10	51	22	29
32	10	721 514 208	10	0.093	1 ½	4	10	58	25	33
40	10	721 514 209	2	0.150	2	6	12	72	29	39
50	10	721 514 210	2	0.228	2 ¼	11	14	83	34	46
63	10	721 514 211	2	0.387	2 ¾	17	18	100	41	58

## Unions for solvent cement jointing



### Union for solvent cement jointing PVC metric

#### Model:

- Union End: solvent socket metric
- Union Bush: Solvent socket metric
- Joining face: with O-ring groove
- Gasket: O-Ring EPDM code no. 748 410 004-016; d90 748 410 248; FKM: 749 410 004-016; d90 749 410 248

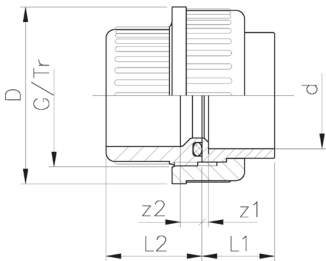

d (mm)	PN (bar)	EPDM Part No.	SP weight (kg)	FKM Part No.	SP weight (kg)		
10	16	721 510 103	10	0.021	721 510 128	10	0.020
12	16	721 510 104	10	0.020	721 510 129	10	0.019
16	16	721 510 105	10	0.025	721 510 130	10	0.025
20	16	721 510 106	10	0.041	721 510 131	10	0.042
25	16	721 510 107	10	0.058	721 510 132	10	0.058
32	16	721 510 108	10	0.083	721 510 133	10	0.084
40	16	721 510 109	10	0.147	721 510 134	10	0.152
50	16	721 510 110	5	0.203	721 510 135	2	0.207
63	16	721 510 111	5	0.356	721 510 136	5	0.361
75	10	721 510 112	2	0.614	721 510 137	2	0.621
90	10	721 510 313	2	0.920	721 510 338	2	0.929
110	10	721 510 114	1	1.434	721 510 139	1	1.492

table continued on the next page

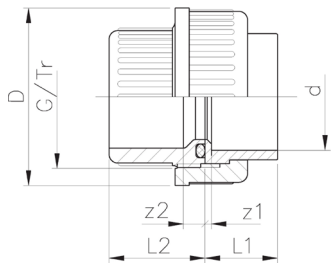

d	z1	z2	D	L1	L2	G/Tr
(mm)	(mm)	(mm)	(mm)	(mm)	(mm)	(inch)
10	3	10	31	15	22	5/8
12	3	10	31	15	22	5/8
16	3	10	35	17	24	3/4
20	3	10	43	19	26	1
25	3	10	51	22	29	1 1/4
32	3	10	58	25	33	1 1/2
40	3	12	72	29	39	2
50	3	14	83	34	46	2 1/4
63	3	18	100	41	58	2 3/4
75	3	18	135	47	62	Tr108x5
90	5	18	158	56	69	Tr128x5
110	5	11	188	66	72	Tr154x6



### Union for solvent cement jointing PVC metric/ASTM

#### Model:

- Union End: Solvent cement socket ASTM
- Union Bush: Solvent socket metric
- Gasket: O-ring EPDM code no. 748 410 005-011
- Gasket: O-ring FKM code no. 749 410 005-011 (to be ordered separately)

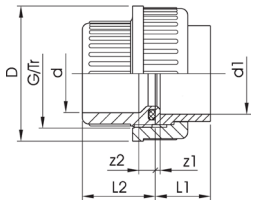

d	PN	Part No.	SP weight	G	z1	z2	D	L1	L2	
(mm)	(bar)		(kg)	(inch)	(mm)	(mm)	(mm)	(mm)	(mm)	
16	16	<b>721 514 105</b>	10	0.022	3/8	3	10	35	22	24
20	16	<b>721 514 106</b>	10	0.042	1	3	10	43	25	26
25	16	<b>721 514 107</b>	10	0.065	1 1/4	3	10	51	28	29
32	16	<b>721 514 108</b>	10	0.103	1 1/2	3	10	58	32	33
40	16	<b>721 514 109</b>	10	0.174	2	3	12	72	35	39
50	16	<b>721 514 110</b>	5	0.239	2 1/4	3	14	83	38	46
63	16	<b>721 514 111</b>	5	0.356	2 3/4	3	18	100	41	58

## Valves



### Type 303 PVC Angle seat check valve With solvent cement spigots metric

#### Model:

- For horizontal or vertical installation

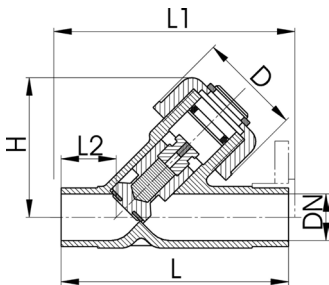

d	DN	PN	Part No.	SP weight	Part No.	SP weight		
(mm)	(mm)	(bar)		(kg)		(kg)		
16	10	10	<b>161 303 005</b>	1	0.075	<b>161 303 030</b>	1	0.094
20	15	10	<b>161 303 006</b>	1	0.113	<b>161 303 031</b>	1	0.132
25	20	10	<b>161 303 007</b>	1	0.170	<b>161 303 032</b>	1	0.172
32	25	10	<b>161 303 008</b>	1	0.288	<b>161 303 033</b>	1	0.290
40	32	10	<b>161 303 009</b>	1	0.444	<b>161 303 034</b>	1	0.448
50	40	10	<b>161 303 010</b>	1	0.791	<b>161 303 035</b>	1	0.798
63	50	10	<b>161 303 011</b>	1	1.345	<b>161 303 036</b>	1	1.345
75	65	10	<b>161 303 012</b>	1	2.483	<b>161 303 037</b>	1	2.499
90	80	10	<b>161 303 013</b>	1	3.514	<b>161 303 038</b>	1	3.540

d	D	H	L	L1	L2	closest inch
(mm)	(mm)	(mm)	(mm)	(mm)	(mm)	(inch)
16	39	58	114	120	24	3/8
20	43	65	124	130	28	1/2
25	47	75	144	150	37	3/4
32	56	90	154	160	37	1
40	64	102	174	180	44	1 1/4

table continued on the next page

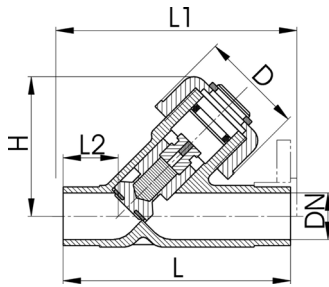

d (mm)	D (mm)	H (mm)	L (mm)	L1 (mm)	L2 (mm)	closest inch (inch)
50	82	123	194	200	48	1 ½
63	95	144	224	230	60	2
75	92	186	284	290	74	2 ½
90	104	204	300	310	85	3



**Check valve type 561 PVC-U**  
With solvent cement sockets metric

**Model:**

- Designed for easy installation and removal
- Vibration free even at high flow velocity
- Flow-optimized return cone, double guided
- For vertical installation
- Compact installation length, same as ball valve type 546
- Z-length, end connectors and union nuts **not** compatible with type 360
- Sealing at a minimum water column of 2 m

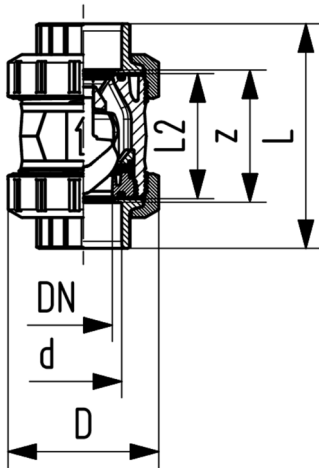

d (mm)	DN (mm)	PN (bar)	Cv-value (l/min)	EPDM Part No.	SP weight (kg)	FKM Part No.	SP weight (kg)
16	10	16	190	161 561 001	1 0.119	161 561 011	1 0.120
20	15	16	180	161 561 002	1 0.117	161 561 012	1 0.119
25	20	16	380	161 561 003	1 0.182	161 561 013	1 0.181
32	25	16	460	161 561 004	1 0.281	161 561 014	1 0.285
40	32	16	850	161 561 005	1 0.480	161 561 015	1 0.488
50	40	16	1080	161 561 006	1 0.714	161 561 016	1 0.750
63	50	16	1670	161 561 007	1 1.344	161 561 017	1 1.376
75	65	16	2950	161 561 008	1 3.160	161 561 018	1 3.170
90	80	16	3600	161 561 009	1 5.040	161 561 019	1 5.060
110	100	16	4150	161 561 010	1 8.130	161 561 020	1 8.170

d (mm)	D (mm)	L (mm)	L2 (mm)	z (mm)	closest inch (inch)
16	50	92	56	64	¾
20	50	95	56	64	½
25	58	110	65	72	¾
32	68	123	71	79	1
40	84	146	85	94	1 ¼
50	97	157	89	95	1 ½
63	124	183	101	107	2
75	166	233	136	144	2 ½
90	200	254	141	151	3
110	238	301	164	174	4





**Check valve type 562 PVC-U**  
**With solvent cement sockets metric**

**Model:**

- For horizontal or vertical installation
- Sealing at a minimum water column of 1m
- Spring loaded, spring made of stainless steel (1.4310)
- Spring available in other materials, see spare parts
- Designed for easy installation and removal
- Vibration free even at high flow velocity
- Flow-optimized return cone, double guided
- Compact installation length, same as ball valve type 546
- Z-length, end connectors and union nuts **not** compatible with type 360

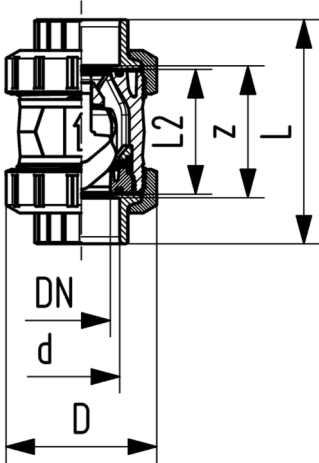

d (mm)	DN (mm)	PN (bar)	Cv-value (l/min)	EPDM Part No.	SP weight (kg)	FKM Part No.	SP weight (kg)
16	10	16	190	161 562 001	1 0.120	161 562 011	1 0.120
20	15	16	180	161 562 002	1 0.130	161 562 012	1 0.130
25	20	16	380	161 562 003	1 0.250	161 562 013	1 0.270
32	25	16	460	161 562 004	1 0.290	161 562 014	1 0.290
40	32	16	850	161 562 005	1 0.510	161 562 015	1 0.510
50	40	16	1080	161 562 006	1 0.750	161 562 016	1 0.750
63	50	16	1670	161 562 007	1 1.330	161 562 017	1 1.340
75	65	16	2950	161 562 008	1 3.160	161 562 018	1 3.170
90	80	16	3600	161 562 009	1 5.040	161 562 019	1 5.060
110	100	16	4150	161 562 010	1 8.130	161 562 020	1 8.170

d (mm)	D (mm)	L (mm)	L2 (mm)	z (mm)	closest inch (inch)
16	50	92	56	64	3/8
20	50	95	56	64	1/2
25	58	110	65	72	3/4
32	68	123	71	79	1
40	84	146	85	94	1 1/4
50	97	157	89	95	1 1/2
63	124	183	101	107	2
75	166	233	136	144	2 1/2
90	200	254	141	151	3
110	238	301	164	174	4

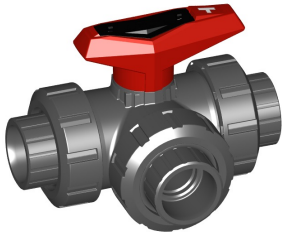

**Type 543 PVC 3-Way ball valve**  
**Horizontal/T-port**  
**With solvent cement sockets metric**

**Model:**

- For easy installation and removal (valve end and union nut are compatible with type 546)
- Ball seats PTFE
- Angle of operation 360° without turn limiter
- Turn limiter 90° enclosed, in different positions usable as a clip-on ring
- Integrated stainless steel mounting inserts

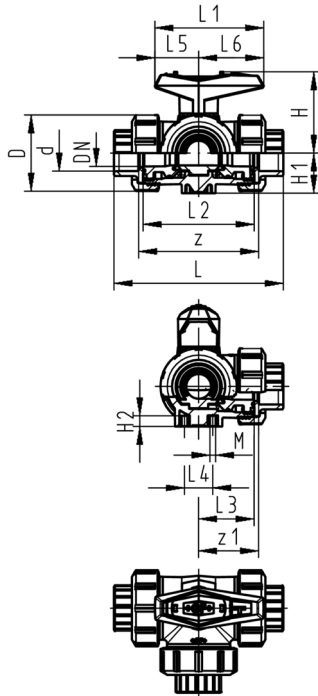

d (mm)	DN (mm)	PN (bar)	Cv-value (l/min)	Part No.	SP	Part No.	SP	weight (kg)
16	10	10	140	161 543 201	1	161 543 211	1	0.244
20	15	10	200	161 543 202	1	161 543 212	1	0.250
25	20	10	470	161 543 203	1	161 543 213	1	0.359
32	25	10	793	161 543 204	1	161 543 214	1	0.544
40	32	10	1290	161 543 205	1	161 543 215	1	0.927
50	40	10	1910	161 543 206	1	161 543 216	1	1.369
63	50	10	3100	161 543 207	1	161 543 217	1	2.660

d (mm)	D (mm)	H (mm)	H1 (mm)	H2 (mm)	L (mm)	L1 (mm)	L2 (mm)	L3 (mm)	L4 (mm)	L5 (mm)	L6 (mm)	M (mm)	z (mm)	z1 (mm)	closest inch (inch)
16	50	57	28	8	109	77	73	36	25	32	45	6	81	40	3/8
20	50	57	28	8	112	77	73	36	25	32	45	6	81	40	1/2
25	58	67	32	8	131	97	86	43	25	39	58	6	94	47	3/4
32	68	73	36	8	151	97	99	50	25	39	58	6	107	54	1
40	84	90	45	9	181	128	120	60	45	54	74	8	130	65	1 1/4
50	97	97	51	9	205	128	137	69	45	54	74	8	143	72	1 1/2
63	124	116	65	9	261	152	179	89	45	66	87	8	185	92	2

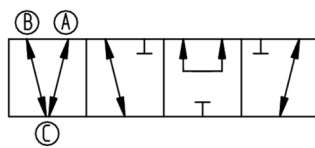
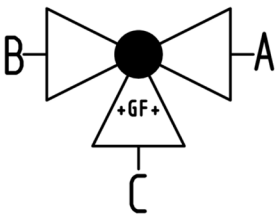

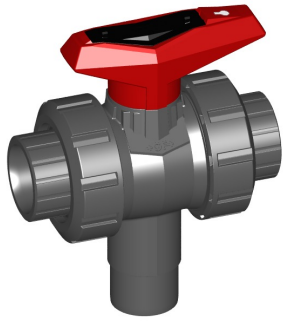

**3-Way ball valve type 543 PVC-U SF**  
**Vertical/L-port**  
**With solvent cement sockets metric**

**Model:**

- Silicone free/paint-compatible
- Vertical inlet solvent cement spigot metric
- Easy installation and removal using union on third outlet
- Ball seats PVDF
- Electric actuator available separately
- Angle of operation 360° without turn limiter
- Delivery status B-C opened, see flow scheme

**Mode of action:**

- For interconnection of two inputs

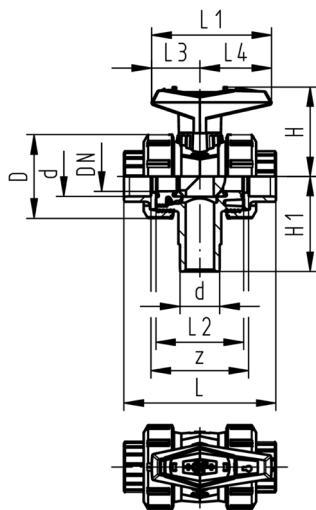
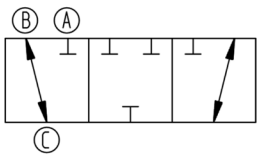
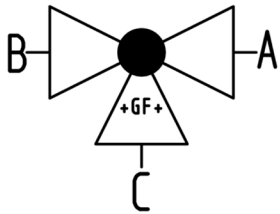

d (mm)	DN (mm)	PN (bar)	Cv-value (l/min)	EPDM Part No.	SP weight (kg)	FKM Part No.	SP weight (kg)
16	10	10	49	<b>161 543 781</b>	1	0.156	<b>161 543 791</b>
20	15	10	77	<b>161 543 782</b>	1	0.166	<b>161 543 792</b>
25	20	10	146	<b>161 543 783</b>	1	0.255	<b>161 543 793</b>
32	25	10	260	<b>161 543 784</b>	1	0.372	<b>161 543 794</b>
40	32	10	437	<b>161 543 785</b>	1	0.622	<b>161 543 795</b>
50	40	10	667	<b>161 543 786</b>	1	0.886	<b>161 543 796</b>
63	50	10	1293	<b>161 543 787</b>	1	1.617	<b>161 543 797</b>

d (mm)	D (mm)	H (mm)	H1 (mm)	L (mm)	L1 (mm)	L2 (mm)	L3 (mm)	L4 (mm)	z (mm)	closest inch (inch)
16	50	57	62	92	77	56	32	45	64	3/8
20	50	57	62	95	77	56	32	45	64	1/2
25	58	67	72	111	97	66	39	58	74	3/4
32	68	73	77	123	97	71	39	58	79	1
40	84	90	87	146	128	85	54	74	95	1 1/4
50	97	97	97	157	128	89	54	74	95	1 1/2
63	124	116	112	183	152	101	66	87	107	2

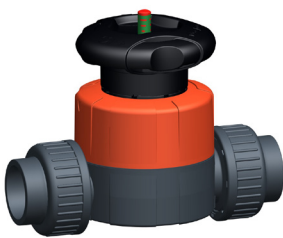

**Type 514 PVC Diaphragm valve**  
**With solvent cement sockets metric**

**Model:**

- Double flow rate compared to predecessor
- One housing nut replaces four screws
- Handwheel with built-in locking mechanism
- Designed for easy installation and removal

**Option:**

- Contact customer services for customization
- Self adjusting multifunctional module with integrated limit switches

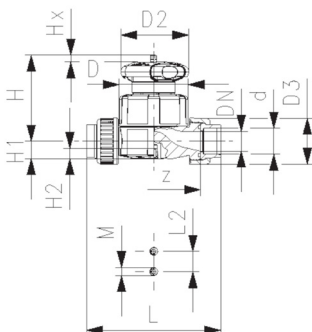

d (mm)	DN (mm)	PN (bar)	Part No.	SP weight (kg)	Part No.	SP weight (kg)
16	10	10	<b>161 514 011</b>	1	0.303	<b>161 514 031</b>
20	15	10	<b>161 514 012</b>	1	0.295	<b>161 514 032</b>
25	20	10	<b>161 514 013</b>	1	0.423	<b>161 514 033</b>

table continued on the next page

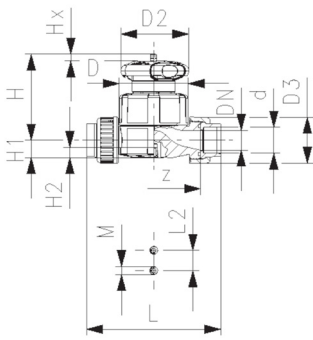

d (mm)	DN (mm)	PN (bar)	Part No.	SP weight (kg)	Part No.	SP weight (kg)
32	25	10	<b>161 514 014</b>	1 0.673	<b>161 514 034</b>	1 1.181
40	32	10	<b>161 514 015</b>	1 0.965	<b>161 514 035</b>	1 0.977
50	40	10	<b>161 514 016</b>	1 1.624	<b>161 514 036</b>	1 1.658
63	50	10	<b>161 514 017</b>	1 2.488	<b>161 514 037</b>	1 2.547

d (mm)	D (mm)	D2 (mm)	D3 (mm)	H (mm)	H1 (mm)	H2 (mm)	L (mm)	L2 (mm)	M	z (mm)	Lift = Hx (mm)	closest inch (inch)
16	65	65	43	73	14	12	170	25	M6	142	7	3/8
20	65	65	43	73	14	12	128	25	M6	96	7	1/2
25	80	65	51	81	18	12	152	25	M6	114	10	3/4
32	88	87	58	107	22	12	166	25	M6	122	13	1
40	101	87	72	115	26	15	192	45	M8	140	15	1 1/4
50	117	135	83	148	32	15	222	45	M8	160	19	1 1/2
63	144	135	100	166	39	15	266	45	M8	190	25	2

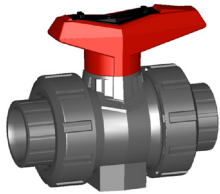

DN10/15 - 50

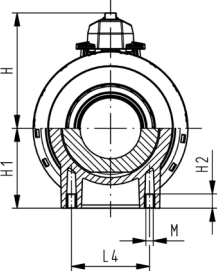
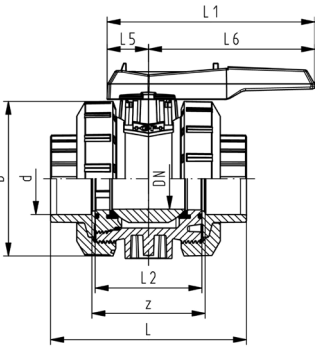
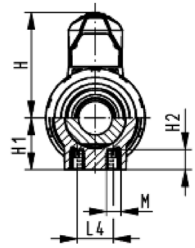
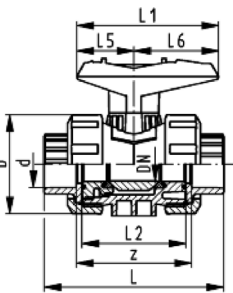
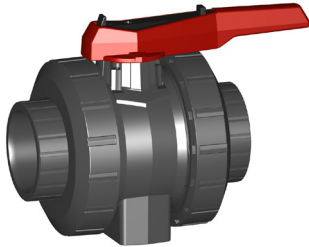

**Ball valve type 546 PVC**  
**With mounting inserts**  
**With solvent cement sockets metric**

**Model:**

- Designed for easy installation and removal
- Ball seats PTFE
- Integrated stainless steel mounting inserts

**Option:**

- Contact customer services for customization
- Multifunctional module with integrated limit switches

d (mm)	DN (mm)	PN (bar)	EPDM Part No.	SP weight (kg)	FKM Part No.	SP weight (kg)
16	10	16	<b>161 546 061</b>	1	<b>161 546 071</b>	1
20	15	16	<b>161 546 062</b>	1	<b>161 546 072</b>	1
25	20	16	<b>161 546 063</b>	1	<b>161 546 073</b>	1
32	25	16	<b>161 546 064</b>	1	<b>161 546 074</b>	1
40	32	16	<b>161 546 065</b>	1	<b>161 546 075</b>	1
50	40	16	<b>161 546 066</b>	1	<b>161 546 076</b>	1
63	50	16	<b>161 546 067</b>	1	<b>161 546 077</b>	1
75	65	16	<b>161 546 068</b>	1	<b>161 546 078</b>	1
90	80	16	<b>161 546 069</b>	1	<b>161 546 079</b>	1
110	100	16	<b>161 546 070</b>	1	<b>161 546 080</b>	1

d (mm)	D (mm)	H (mm)	H1 (mm)	H2 (mm)	L (mm)	L1 (mm)	L2 (mm)	L4 (mm)	L5 (mm)	L6 (mm)	M (mm)	z (mm)	closest inch (inch)
16	50	57	27	12	92	77	56	25	32	45	6	64	3/8
20	50	57	27	12	95	77	56	25	32	45	6	64	1/2
25	58	67	30	12	110	97	65	25	39	58	6	72	3/4
32	68	73	36	12	123	97	71	25	39	58	6	79	1
40	84	90	44	15	146	128	85	45	54	74	8	94	1 1/4
50	97	97	51	15	157	128	89	45	54	74	8	95	1 1/2
63	124	116	64	15	183	152	101	45	66	87	8	107	2
75	166	149	85	15	233	270	136	70	64	206	8	144	2 1/2
90	200	161	105	15	254	270	141	70	64	206	8	151	3
110	238	178	123	22	301	320	164	120	64	256	12	174	4

# Flange Adapters

## Flange Adapter PVC

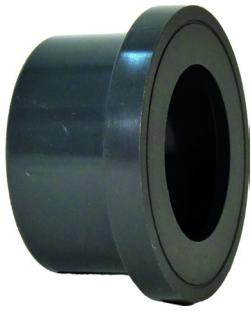

### Flange adapter PVC Combined jointing face flat and serrated metric

#### Model:

- Solvent cement socket metric
- d16 - d50: Sealing surface flat
- d63 - d400: combined jointing face flat and serrated

#### Note:

Gasket: Profile flange gasket EPDM code no. 748 440 705-725, FPM code no. 749 440 705-725 or flat gasket EPDM code no. 748 440 705-725, only use O-ring EPDM code no. 748 410 000-174, FPM code no. 749 410 000-174 in combination with counterpart flange adapter code no. 721 810 105-123

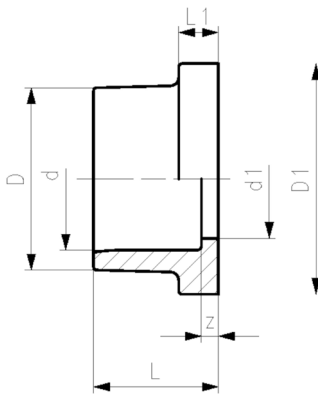

DN (mm)	d (mm)	PN (bar)	Part No.	SP	weight (kg)	D1 (mm)	z (mm)	d1 (mm)	L (mm)	D (mm)	L1 (mm)
10	16	16	721 800 105	10	0.006	29	3	13	17	22	6
15	20	16	721 800 106	10	0.009	34	3	16	19	27	6
20	25	16	721 800 107	10	0.015	41	3	21	22	33	7
25	32	16	721 800 108	10	0.024	50	3	28	25	41	7
32	40	16	721 800 109	10	0.039	61	3	36	29	50	8
40	50	16	721 800 110	10	0.056	73	3	45	34	61	8
50	63	16	721 790 111	10	0.103	90	3	57	41	77	9
65	75	16	721 790 112	10	0.159	106	3	69	47	91	10
80	90	16	721 790 113	10	0.253	125	5	82	56	108	11
100	110	16	721 790 114	10	0.417	150	5	102	66	131	12
125	140	16	721 790 116	6	0.725	188	5	132	81	165	14
150	160	16	721 790 117	2	1.093	213	5	152	91	188	16
200	200	10	721 790 119	2	1.460	250	6	192	112	224	24
200	225	10	721 790 120	2	1.743	274	6	217	125	248	25



### V- Flange Ring PVC metric

#### Model:

- For socket systems metric and BS
- Connecting dimension: ISO 7005, EN 1092, BS 4504, DIN 2501
- **Bolt circle PN 10**
- Maximum medium- or ambient temperature 45 °C

1) Suitable for socket -and butt fusion systems

2) Connecting dimension: ISO 2536. bolt circle acc. DN125. suitable for flange adaptor d125/ DN100

3) Connecting dimension: ISO 2536. bolt circle acc. DN225. suitable for flange adapter d250/ DN250

AL: number of holes

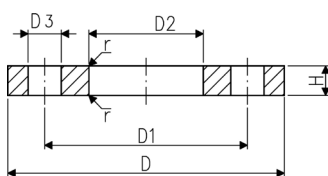
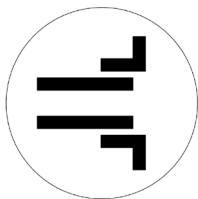

d (mm)	DN (mm)	PN (bar)	Part No.	SP	weight (kg)	D (mm)	D1 (mm)	D2 (mm)	D3 (mm)	H (mm)	r (mm)	AL	SC
16	10	10	721 700 005	100	0.053	90	60	23	14	10	1	4	M12
20	15	10	721 700 006	90	0.067	95	65	28	14	11	1	4	M12
25	20	10	721 700 007	50	0.092	105	75	34	14	12	2	4	M12
32	25	10	721 700 008	40	0.133	115	85	42	14	14	2	4	M12
40	32	10	721 700 009	25	0.198	140	100	51	18	15	2	4	M16
50	40	10	721 700 010	20	0.247	150	110	62	18	16	2	4	M16
63	50	10	721 700 011	30	0.312	165	125	78	18	18	3	4	M16
75	65	10	721 700 012	25	0.376	185	145	92	18	19	3	4	M16
90	80	10	721 700 013	20	0.464	200	160	110	18	20	3	8	M16
110	100	10	721 700 014	30	0.543	220	180	133	18	22	3	8	M16
160	150	10	721 700 017	5	1.009	285	240	190	22	28	4	8	M20
200	200	10	721 700 019	8	1.669	340	295	226	22	32	4	8	M20
225	200	10	721 700 020	8	1.377	340	295	250	22	32	4	8	M20



# General Terms and Conditions of Sale

Always check for the most current General Terms and Conditions and Warranty Statement at [www.gfpiping.com](http://www.gfpiping.com) under "Catalogs and Pricing"

These GF Piping Systems USA Terms and Conditions (Rev.11/2018) supersede all previous Terms and Conditions for Georg Fischer LLC and Georg Fischer Harvel LLC.

It is the responsibility of the Distributor, Dealer, or Agent to provide a current copy of these Terms and Conditions to the Consumers of Georg Fischer Piping products.

Always check for the most current General Terms and Conditions and Warranty Statement at [www.gfpiping.com](http://www.gfpiping.com) under "Price Lists," which supersede and replace these General Terms and Conditions and Warranty Statement. If unable to access this website please request a copy at (714) 731-8800.

## Acceptance of Terms and Conditions

Acceptance by Customer of GF Piping Systems USA, (hereinafter "Seller") offer of Products for sale is hereby expressly conditioned upon Customer's acceptance of these General Terms and Conditions of Sale and these General Terms and Conditions of Sale will be deemed accepted, as written, despite any language in Customer's purchase order and/or other documentation which is either conflicting or supplemental, unless promptly after this offer, Customer specifically advises Seller of each term and condition not so accepted and Seller accepts Customer's conflicting and/or supplemental term(s) in writing.

## Order Acceptance

Seller reserves the right to accept or reject any order. Possession of a price list by Customer does not constitute an offer to sell.

### Credit Approval and Minimum Order Charge

Customer credit approval is required prior to any shipment.

The minimum order is \$100 net.

## List Price, Discount or Freight Charges

List prices, discount, and freight terms are subject to change without notice. All prices are F.O.B. Seller's factory or authorized warehouse at Seller's discretion.

## Quotes

All prices provided by the Seller are in US currency and cover only the goods expressly specified. Quotations are valid for a period of 30 days unless otherwise specified. HDPE Pipe pricing is valid for seven (7) days after quote issuance unless otherwise stated or unless there has been fundamental change to our cost exposure within the seven (7) day period.

## Payment Terms

Net 30, from date the invoice is issued unless otherwise stated in a specific quotation. No unauthorized deductions allowed, such as deductions for pending Return Material Transactions that are subject to review. Seller reserves the right to apply a finance charge to the balance of any past-due invoice (over 30 days from date of invoice) at a rate of 1.5% per month, 18% per annum. Payment terms on fusion machine rentals net 30; see rental agreement for more details.

## Taxes

Seller charges Customer for all sales, excise and other taxes and governmental charges Seller is required to collect from Customer. Customers claiming exemption must furnish documentation required by law, which is satisfactory to Seller to permit Seller to refrain from collecting such charges.

## Order Changes or Cancellations

Cancellation or modifications of orders may be possible only with prior written consent from Seller. Since all orders are individually entered for processing immediately upon receipt, Seller reserves the right to charge back to the Customer costs incurred from either order cancellation or order modification. Seller also reserves the right to consider all order additions as new orders and subject to all terms and conditions. Seller will not cancel orders for custom or non-cancelable products if Seller has already produced the product or incurred expenses toward producing the product at the time the Customer seeks to cancel.

## Delivery

Seller disclaims liability for consequential damages from late deliveries unless seller assumes liability for such damages in writing when the order is placed. Further, Seller disclaims liability where delivery delays caused by strike, differences with workmen, or causes beyond Seller's control, including but not limited to fires, floods, accidents, government actions, shortages of labor, raw materials, production facilities, or transportation. Where delivery delays are caused by labor problems, Seller is not obligated to seek or obtain any settlement, which, in Seller's judgment, is not in Seller's best interest.

## Standard Packaging

Seller will accept orders from Customer exclusively in multiples of the standard packaging quantity or boxed quantity. Seller reserves the right to reject any order that is not a standard packaging or boxed quantity of a Product.

## Freight

Continental US – Full freight will be paid on the following orders:

1. Pipe \$8,000 net or greater in one of the following categories:

Combination of products to meet freight allowance is at the sole discretion of the Seller.

2. Fittings, Valves, & Actuation \$2,200 net or greater

Freight allowed orders will be sent by a designated carrier of Seller's choice. Additional charges will be invoiced to Customer for special handling and airfreight when requested. Standard Pipe lengths require long truck beds for shipping and may be shipped separately from valves and/or fittings purchased on the same order. Valves and/or fittings will be shipped using practical shipping methods.

Freight will not be paid on the following orders:

Unless otherwise specified, shipments are surface, prepaid and added to invoice.

## Mode of Shipment and Packaging

Seller reserves the right to ship orders in the most economical manner, as long as the product is shipped on or before the promised ship date. If product ships after the promised ship date, Seller may automatically adjust the shipping method to help improve delivery of the delayed shipment, at no additional cost. If Seller pays freight, Seller may hold shipment until all items become available. Customer bears extra cost of non-standard packaging or handling requested by Customer.

### Transfer of Ownership

All products are FOB Seller's facility and title of merchandise transfers when product is loaded onto carrier. Claims for damaged merchandise should be made to carrier by Customer.

## Non-Conforming Shipments

Customer must notify Seller in writing within 7 days after receipt of shipments not conforming with Customer's order, stating specifically Customer's claim of non-conformity, or Customer is deemed to accept the shipment as is. If Seller is satisfied the shipment is non-conforming, Seller will (i) credit Customer for the price of defective goods or goods shipped but not ordered (including allocated outbound and return freight) upon return of goods; (ii) promptly ship omitted items waiving Seller's new order charges. Customer is required to make timely payment to Seller of any amount, which is undisputed, or not subject to such claims.

## Return of Goods for Credit

Seller accepts returns of certain Engineered Piping Products, Valve and Actuation Products, Signet Instrumentation Products, Waste and Containment Products, PVC/CPVC/HDPE Fittings and Accessories for a standard restock charge of 25%. Pipe and Custom Products are not returnable. Products denoted with a caret (^) symbol in front of the part number in the current Master Distributor Price List have a 40% restock and products denoted with an asterisk (\*) symbol are non-cancelable/non-returnable. Only products purchased within the past six (6) months, in original "like new" packaging (full carton quantities), of current design, and listed in the current Master Distributor Price List shall be considered for returns. All products qualifying for return are subject to review for marketability (quantities in question in relationship to historical stock movement) before issuance of a Return Material Authorization (RMA) number. Returns due to Seller's product warranty or order entry/shipping error will not be charged a restock fee. Product for credit consideration should be returned to location designated by Seller. All returns are subject to inspection upon receipt. No credit will be issued until the returned material has been inspected, accepted, and processed. Customers will be contacted if quantity differences and/or non-acceptable material are found during inspection. Any credit issued will reflect only quantities actually received and accepted by Seller. Disposition (return to Customer or scrap) of returned product not accepted back by Seller must be provided by Customer within 10 business days, otherwise it will be subject to disposal. All material returns must be accompanied by a valid Return Material Authorization (RMA) number. RMA numbers may be obtained from the Inside Sales Department. When requesting a RMA, the original purchase order number and date of purchase must be provided. All material returns must be received within thirty (30) days of the RMA issuance. All material returns must be shipped freight prepaid and arrive to Seller's location in saleable condition. No collect shipments will be accepted by Seller. Restock charges and prepaid freight do not apply to warranty defective merchandise or returns due to Seller order entry or shipping errors.

## Return of Goods for Warranty Evaluation

When requesting a RMA for material evaluation, Customer must first complete and submit a Material Safety Disclosure sheet and Request For Evaluation form obtained from Customer Service. Material

arriving to Seller without a valid RMA number will be returned to the customer/distributor, freight collect. RMA numbers must be clearly referenced on all shipping documents and shipping containers.

## Technical Documentation and Intellectual Property

Unless specified otherwise, technical documents such as drawings, descriptions, illustrations and the like constitute only an approximate guide. Seller reserves the right to make any changes considered necessary. Seller expressly reserves any and all intellectual property rights therein.

## Warranty and Limitations

Seller's Products are carefully inspected for manufacturing defects; however, it is not always possible to detect hidden defects.

Seller warrants that its products and/or services shall conform to the description of such products or services as provided to Customer by Seller through Seller's catalog, analytical data or other literature. **THIS WARRANTY IS EXCLUSIVE, AND SELLER MAKES NO OTHER WARRANTY, EXPRESS OR IMPLIED, INCLUDING ANY IMPLIED WARRANTY OF MERCHANTABILITY OR FITNESS FOR ANY PARTICULAR PURPOSE OR COURSE OF DEALING OR USAGE OF TRADE – WHICH ARE HEREBY DISCLAIMED.**

Seller's warranties made in connection with the sale of Products shall not be effective if Seller has determined, in its sole discretion, that Customer has misused the products in any manner, has failed to use the products in accordance with industry standards and practices, or has failed to use the products in accordance with instructions, if any, furnished by Seller. Seller does not warrant any Products or Services obtained through an unauthorized Distributor, Dealer, or Agent.

## Limitations of Remedy

Seller's sole and exclusive liability and Customer's exclusive remedy with respect to products proved to Seller's satisfaction to be defective or nonconforming shall be repair or replacement of such products without charge or refund of the purchase price, in Seller's sole discretion, upon the return of such products in accordance with Seller's instructions. **SELLER SHALL NOT IN ANY EVENT BE LIABLE FOR INDIRECT, DIRECT, INCIDENTAL, CONSEQUENTIAL OR SPECIAL DAMAGES OF ANY KIND RESULTING FROM ANY USE OR FAILURE OF THE PRODUCTS, OR IN CONNECTION WITH ANY SERVICES, EVEN IF SELLER HAS BEEN ADVISED OF THE POSSIBILITY OF SUCH DAMAGE INCLUDING, WITHOUT LIMITATION, LIABILITY FOR LOSS OF USE, LOSS OF WORK IN PROGRESS, DOWN TIME, LOSS OF REVENUE OR PROFITS, FAILURE TO REALIZE SAVINGS, LOSS OF PRODUCTS OF CUSTOMER OR OTHER USE, ANY LIABILITY OF CUSTOMER TO A THIRD PARTY ON ACCOUNT OF SUCH LOSS, OR FOR ANY OTHER EXPENSE, DAMAGE OR LOSS OCCASIONED BY SUCH PRODUCT OR SERVICE, INCLUDING PERSONAL INJURY OR PROPERTY DAMAGE.**

**Any and all claims of Customer against Seller must be brought within one (1) year of Seller's tender of delivery, regardless of their nature.**

## Services

In the event Seller provides any technical or other information, advice, suggestions, assistance, work, training, or services of any kind to Buyer ("Services"), whether or not for a fee, **SELLER MAKES NO WARRANTIES, EXPRESS OR IMPLIED, ORAL OR WRITTEN, WITH RESPECT TO SUCH SERVICES, EXCEPT AS STATED IN THESE TERMS AND CONDITIONS.** The willingness of Seller to provide the Services is based upon Buyer's acceptance of and agreement to the terms, conditions, and obligations set forth herein and in any related Service Agreement signed by Buyer.

## Welder Certifications

Training and certifications, for example, Level I, II, III (Welder Certifications) are provided based on the agreement of Buyer to follow and conform to all instructions, recommendations, and requirements of such certifications and related training. Buyer shall indemnify, defend and forever hold Seller and its directors, officers, employees, agents, suppliers, parents, affiliates, subsidiaries, successors and assigns harmless from any and all fines, penalties, suits, actions, claims, liabilities, judgments, costs, and expenses (including reasonable attorneys' fees) resulting or arising from the acts or omissions of Buyer, its directors, officers, employees, agents, suppliers, customers, parents, affiliates, subsidiaries, successors and assigns (all collectively referred to herein as "Buyer") related to or arising from Welder Certifications, or the performance of any related work by Buyer. The foregoing shall apply, but shall not be limited to, injury to person (including death) or damage or harm to property or the environment. Buyer shall not be obligated to indemnify Seller for any fine, penalty, suit, action, claim, liability, judgment, cost, or expense to the extent attributable to Seller's negligence or willful misconduct.

## Export Law Compliance

Buyer represents that Products will not be diverted, transshipped, exported or re-exported to any country whatsoever, except in accordance with all applicable United States laws and regulations, including, but not limited to the Export Administration Act of 1979, and the regulations issued thereunder.

## EU GDPR Compliance

Seller affiliates are subject to the European Union's General Data Privacy Regulation [Regulation (EU) 2016/679] (the "GDPR") when acting as a controller or processor of personal data of an individual data subject located in the European Union, as those terms are defined in the GDPR. Buyer acknowledges and agrees that it may be acting as a processor of personal data for Seller or its affiliates under these Terms and Conditions and that all applicable requirements of the GDPR are incorporated by reference herein. Buyer represents and warrants that (1) it is aware of and understands its compliance obligations under GDPR; (2) it will process personal data received from Seller or its affiliates only in accordance with Seller instructions and only in compliance with GDPR; and (3) with regard to its obligations under these Terms and Conditions it shall comply with all applicable requirements of the GDPR to the same extent as required for Seller.

## Assignment

Customer may not assign its rights under or interest in any purchase order without the prior written consent of Seller. These terms and conditions of sale shall be binding upon and inure to the benefit of Customer and Seller, their successors and permitted assigns.

## Applicable Law

The sale and purchase of Products and/or Services shall be governed by, and these terms and conditions shall be interpreted in accordance with the laws of the State where the Products purchased hereunder are manufactured or Services purchased hereunder are performed. All disputes hereunder shall be resolved in courts of competent jurisdiction located within the State where the Products sold or Services performed hereunder are manufactured or performed. The parties hereby waive the right to trial by jury.

## Relationship of the Parties

The relationship between the parties shall be that of Seller and independent contractor. Neither Party shall be the agent of the other or have authority to act on behalf of the other party, except in a manner and to the extent provided herein or otherwise agreed to in writing. There is no special relationship between the parties or between Seller and any customer of Buyer. This Agreement creates a contractual relationship among the parties hereto, and creates no other relationship, including but not limited to a franchise, partnership, joint venture, agency, or any form of fiduciary or special relationship. Buyer agrees that it will never represent itself to third parties as having any relationship with Seller other than that of independent contractor.

## Entire Agreement

These terms and conditions constitute the entire and complete agreement between Seller and Buyer concerning the sale and purchase of Products or Services. Neither party shall claim any modification, amendment or release from any of these terms and conditions unless the parties have entered into a mutual agreement to that effect, signed by Buyer and Seller.

# Stress Less<sup>®</sup>

## Pipe and Valve Support System

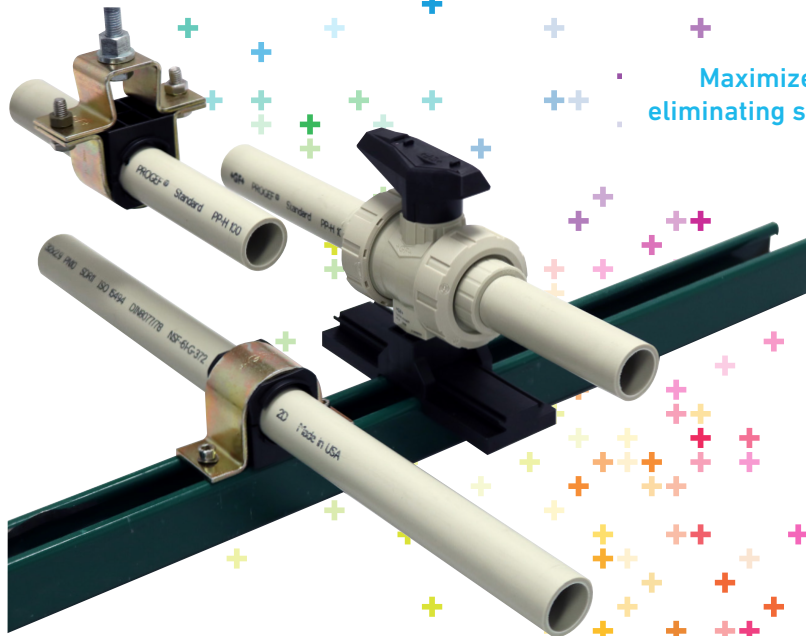

Patented

Maximize the service life of your piping system by eliminating stress at pipe and valve support locations.

### Stress Less<sup>®</sup> Pipe Guides

**Soft touch.** Piping can easily slide in insert with absolute minimal stress and wear during each thermal expansion cycle. Piping can never touch metal.

**Engineered for control.** Guide inserts have a designed, engineered gap around the OD of the clamped piping. This allows controlled movement and simplifies the system design: no need to account for load accelerations during seismic or water hammer events.

**Strong and user friendly.** The guide insert fits precisely within the steel hoop, which has two functions. First, it provides the necessary strength to support the weight of the piping in normal conditions (for example, 10 times the weight of the pipe when filled with media) and even during a very strong earthquake (subjected to seismic accelerations over 5G). Second, the installer tightens down only the steel hoop and cannot overtighten the guide against the pipe.

**Firm grip.** Optionally, we offer pipe supports with an elastomer insert for vertically installed pipe.

### Stress Less<sup>®</sup> Valve Supports

GF Piping Systems introduces a new and unique product that allows valves to move in two directions as the pipe expands and contracts, all in a controlled manner and while properly supported.

**Controlled movement.** The support base and slide components are made of low friction PP. Valves can slide with virtually no resistance. Range of travel is  $\pm 3$  inches (6 inches total).

**Practical.** Designed to keep centerlines of piping aligned when Stress Less pipe guides and valve supports are used together.

Designed to securely and easily mount all of the following GF valves, in any material, manual and actuated.

- Type 546 ball valves
- Type 523 ball valves
- Type 543 horizontal 3-way valves
- 5-Series diaphragm valves

Our sales companies and representatives ensure local customer support in over 100 countries.

## Argentina / Southern South America

Georg Fischer Central Plastics  
Sudamérica S.R.L.  
Buenos Aires, Argentina  
Phone +5411 4512 02 90  
gfccentral.ps.ar@georgfischer.com

## Australia

Georg Fischer Pty Ltd  
Riverwood NSW 2210 Australia  
Phone +61(0)2 9502 8000  
australia.ps@georgfischer.com  
www.georgfischer.com.au

## Austria

Georg Fischer  
Rohrleitungssysteme GmbH  
3130 Herzogenburg  
Phone +43(0)2782 856 43-0  
austria.ps@georgfischer.com  
www.georgfischer.at

## Belgium / Luxembourg

Georg Fischer NV/SA  
1070 Bruxelles/Brüssel  
Phone +32(0)2 556 40 20  
be.ps@georgfischer.com  
www.georgfischer.be

## Brazil

Georg Fischer Sist. de Tub. Ltda.  
04795-100 São Paulo  
Phone +55(0)11 5525 1311  
br.ps@georgfischer.com  
www.georgfischer.com.br

## Canada

Georg Fischer Piping Systems Ltd  
Mississauga, ON L5T 2B2  
Phone +1(905)670 8005  
Fax +1(905)670 8513  
ca.ps@georgfischer.com  
www.georgfischer.ca

## China

Georg Fischer Piping Systems Ltd  
Shanghai 201319  
Phone +86(0)21 3899 3899  
china.ps@georgfischer.com  
www.georgfischer.cn

## Denmark / Iceland

Georg Fischer A/S  
2630 Taastrup  
Phone +45 (0)70 22 19 75  
info.dk.ps@georgfischer.com  
www.georgfischer.dk

## Finland

Georg Fischer AB  
01510 VANTAA  
Phone +358 (0)9 586 58 25  
Fax +358 (0)9 586 58 29  
info.fi.ps@georgfischer.com  
www.georgfischer.fi

## France

Georg Fischer SAS  
95932 Roissy Charles de Gaulle Cedex  
Phone +33(0)1 41 84 68 84  
fr.ps@georgfischer.com  
www.georgfischer.fr

## Germany

Georg Fischer GmbH  
73095 Albershausen  
Phone +49(0)7161 302-0  
info.de.ps@georgfischer.com  
www.georgfischer.de

## India

Georg Fischer Piping Systems Ltd  
400 076 Mumbai  
Phone +91 224007 2001  
in.ps@georgfischer.com  
www.georgfischer.in

## Italy

Georg Fischer S.p.A.  
20063 Cernusco S/N (MI)  
Phone +3902 921 861  
it.ps@georgfischer.com  
www.georgfischer.it

## Japan

Georg Fischer Ltd  
556-0011 Osaka,  
Phone +81(0)6 6635 2691  
jp.ps@georgfischer.com  
www.georgfischer.jp

## Korea

Georg Fischer Piping Systems  
271-3 Seohyeon-dong Bundang-gu  
Seongnam-si, Gyeonggi-do  
Seoul 463-824  
Phone +82 31 8017 1450  
Fax +82 31 8017 1454  
kor.ps@georgfischer.com  
www.georgfischer.kr

## Malaysia

George Fischer (M) Sdn. Bhd.  
No. 2, 4 & 6, Jalan Permata 3/KS 09  
Taman Perindustrian Air Hitam  
41200 Klang, Selangor Darul Ehsan  
Phone +60 (0) 3 3122 5585  
Fax +603 3122 5575  
my.ps@georgfischer.com  
www.gfps.com/my

## Mexico / Northern Latin America

Georg Fischer S.A. de C.V.  
Apodaca, Nuevo Leon  
CP66636 Mexico  
Phone +52 (81)1340 8586  
Fax +52 (81)1522 8906  
mx.ps@georgfischer.com  
www.georgfischer.mx

## Middle East

Georg Fischer  
Piping Systems (Switzerland) Ltd.  
Dubai, United Arab Emirates  
Phone +971 4 289 49 60  
gcc.ps@georgfischer.com  
www.export.georgfischer.com

## Netherlands

Georg Fischer N.V.  
8161 PA Epe  
Phone +31(0)578 678 222  
nl.ps@georgfischer.com  
www.georgfischer.nl

## New Zealand

Georg Fischer Ltd  
13 Jupiter Grove, Upper Hutt 5018  
PO Box 40399, Upper Hutt 5140  
Phone +64(0)4 527 9813  
nz.ps@georgfischer.com  
www.gfps.com/nz

## Norway

Georg Fischer AS  
1351 Rud  
Phone +47(0)67 18 29 00  
no.ps@georgfischer.com  
www.georgfischer.no

## Poland

Georg Fischer Sp. z o.o.  
05-090 Sekocin Nowy  
Phone +48(0)22 31 31 0 50  
poland.ps@georgfischer.com  
www.georgfischer.pl

## Romania

Georg Fischer  
Piping Systems (Switzerland) Ltd.  
020257 Bucharest - Sector 2  
Phone +40(0)21 230 53 80  
ro.ps@georgfischer.com  
www.export.georgfischer.com

## Russia

Georg Fischer  
Piping Systems (Switzerland) Ltd.  
Moscow 125047  
Tel. +7 495 258 60 80  
ru.ps@georgfischer.com  
www.georgfischer.ru

## Singapore

Georg Fischer Pte Ltd  
11 Tampines Street 92, #04-01/07  
528 872 Singapore  
Phone +65 6747 0611  
sgp.ps@georgfischer.com  
www.sg.piping.georgfischer.com

## Spain / Portugal

Georg Fischer S.A.  
28046 Madrid  
Phone +34(0)91 781 98 90  
es.ps@georgfischer.com  
www.georgfischer.es

## Sweden

Georg Fischer AB  
117 43 Stockholm  
Phone +46(0)8 506 775 00  
info.se.ps@georgfischer.com  
www.georgfischer.se

## Switzerland

Georg Fischer  
Rohrleitungssysteme (Schweiz) AG  
8201 Schaffhausen  
Phone +41(0)52 631 30 26  
ch.ps@georgfischer.com  
www.piping.georgfischer.ch

## Taiwan

Georg Fischer Co., Ltd.  
San Chung Dist., New Taipei City  
Phone +886 2 8512 2822  
Fax +886 2 8512 2823  
www.georgfischer.tw

## United Kingdom / Ireland

Georg Fischer Sales Limited  
Conventry, CV2 2ST  
Phone +44(0)2476 535 535  
uk.ps@georgfischer.com  
www.georgfischer.co.uk

## USA / Caribbean

Georg Fischer LLC  
Irvine, CA 92618  
Phone +1(714) 731 88 00  
Toll Free 800 854 40 90  
us.ps@georgfischer.com  
www.gfpiping.com

## Vietnam

Georg Fischer Pte Ltd  
136E Tran Vu, Ba Dinh District, Hanoi  
Phone +84 4 3715 3290  
Fax +84 4 3715 3285

## International

Georg Fischer  
Piping Systems (Switzerland) Ltd.  
8201 Schaffhausen/Switzerland  
Phone +41(0)52 631 30 03  
Fax +41(0)52 631 28 93  
info.export@georgfischer.com  
www.export.georgfischer.com

## www.gfps.com

The technical data is not binding. They neither constitute expressly warranted characteristics nor guaranteed properties nor a guaranteed durability. They are subject to modification. Our General Terms of Sale apply.

## GF Piping Systems

9271 Jeronimo Road, Irvine, CA 92618

Tel. (714) 731-8800, Toll Free (800) 854-4090, Fax (800) 426-7188

e-mail: us.ps@georgfischer.com

www.gfpiping.com

