

# ABS

## Product Catalogue

Pipe, Fittings & Valves for Cooling,  
Chilled Water, Water Treatment, Marine  
and Drinking Water



## Technical Information

---

For technical data including operating & control pressures, dimensions as well as the use of accessories, please refer to data sheets which are available in both printed and electronic (pdf) formats from the Coventry Sales Office (details on back cover).

For details of our range of plastic pipe, fittings, manual and actuated operated valves in PVC-U, PVC-C, PP, PVDF, and PE as well as our INSTAFLEX PB, AQUASYSTEM PP-R and SIGNET measurement and control range, please contact the Coventry Sales Office.

### Important Note

The technical data given in this catalogue is for preliminary information purposes only and is published without guarantee. All pictures and drawings are for illustrative purposes only and should not be regarded as wholly accurate in every detail. We reserve the right to withdraw or to alter the specification of any product without notice. Please consult our Terms and Conditions [www.gfps.com/uk](http://www.gfps.com/uk)

# The best choice for you

## Corrosion and chemical resistant system solutions

### + Georg Fischer

Georg Fischer focuses on three core businesses: GF Piping Systems, GF Automotive and GF Machining Solutions. The industrial corporation founded in 1802 headquarters in Switzerland and operates approximately 130 companies with more than 14 000 employees across 30 countries.

GF Piping Systems is a leading supplier of plastic and metal piping systems with global market presence. For the treatment and distribution of water and chemicals, as well as the safe transport of liquids and gases in industry, we have the corresponding jointing technologies, fittings, valves, automation products and pipes in our portfolio.



GF Piping Systems headquarters in Schaffhausen, Switzerland.

### + Our market segments

Being a strong partner, GF Piping Systems supports its customers in every phase of the project. No matter which processes and applications are planned in the following market segments:

- Building Technology
- Chemical Process Industry

- Energy
- Food & Beverage / Cooling
- Microelectronics
- Marine
- Water & Gas Utilities
- Water Treatment

### + Global presence

Our global presence ensures customer proximity worldwide. Sales companies in over 26 countries and representatives in another 80 countries provide customer service around the clock. With 48 production sites in Europe, Asia and the USA we are close to our customers and comply with local standards. A modern logistics concept with local distribution centres ensures highest product availability and short delivery times. GF Piping Systems specialists are always close by.

### + Complete solutions provider

Our extensive product range represents a unique form of product and competence bundling. With over 60 000 products, allied with a broad range of services, we offer individual and comprehensive system solutions for a variety of industrial applications. Our automation offering perfectly fits into our complete system approach and is thus an integral part of our portfolio. Having the profitability of the project in focus, we optimise processes and applications that are integrated into the whole system.

Continually setting standards in the market, we directly provide our customers with technological advantages. Due to our worldwide network customers benefit directly from over 50 years of experience in plastics.

From start to finish, we support our customers as a competent, reliable and experienced partner, actively contributing the know-how of an industrial company that has been successful in the market for over 200 years.

# Value added services

## From planning support to implementation – our specialists are always close by

As a leading provider of piping systems in plastic and metal, we offer our customers not only reliable products, but also a large package of services. Our support ranges from a comprehensive technical manual or the extensive CAD library to an international team of experts, who work closely together with local sales companies. And when it comes to implementing a project, our customers additionally benefit from a wide range of training courses, either on site or in our modern training centres worldwide.

Generating a genuinely individual added value for our customers is our ultimate goal when implementing our tailor-made solutions. With our application knowledge and product expertise, we support our customers during the planning process, the sustainable realisation of the projects and the provision of services. Our expertise in developing and producing piping systems, combined with our profound industry and market knowledge, based on longstanding experience, makes us a qualified and professional partner for our customers.

### 1 Chemical resistance

Our specialist teams have decades of experience in the area of chemical resistance. They can offer individual support and advice in selecting the right material for the corresponding system solution. On request, a team will examine and select the appropriate material for special applications.

### 2 CAD library

The extensive CAD library is the most frequently used planning tool at GF Piping Systems. The database comprises over 30,000 drawings and technical data regarding pipes, fittings, measurement and control technology as well as manual and actuated valves. The big advantage of the CAD library is that the data can be integrated directly in CAD models.

### 3 Technical support

Technical support and material selection are key factors for a successful installation. A team of specialists headquartered in Switzerland is available to support the GF Piping Systems sales companies around the world. For technical advice or for general information, our customers are supported individually by the specialist team in the corresponding sales company.

### 4 Online and mobile calculation tools

Our numerous, multilingual online calculation tools are very useful for configuring and calculating. By means of pressure/temperature diagrams, the pressure of liquid media recommended for pipes and fittings at various temperatures can be easily defined. FlowCalc App, the mobile application of GF Piping Systems, is an on-site planning tool for pipe diameter and flow velocity calculation to select the right dimension of piping systems when no expert is near by.

### 5 On-site training

Our experts are available to support our customers locally and conduct training in diverse fusion and jointing techniques on location. The duration and structure of the training depends on the project and the system being installed.

### 6 Customising

The customising teams at GF Piping Systems work closely together around the globe. The focus of these teams is to manufacture custom parts for special systems. In addition, a variety of special solutions can be produced in small series. Standardized processes warrant the highest level of quality for the individual solutions of our customers.



7

#### Planning Fundamentals

For our customers, we have documented the extensive know-how of GF Piping Systems in planning and installing plastic piping systems in our technical manual. This detailed documentation is available in both printed and digital version. The established reference book is helpful in planning large and small projects.

8

#### Training courses

GF Piping Systems offers a wide range of training courses that allow participants to gain confidence in working with our products and proven jointing technologies. The practical training is clearly defined, structured and adapted to the various levels of participants' experience.

## + Worldwide Approval

GF ABS is manufactured and tested to the highest quality. Our own compound and strict quality controls for each material delivery form the basis for our high quality products,

Our own independently accredited test laboratory for components of plastic piping systems according to EN ISO 45001 assures the highest quality.

Quality and environmental management systems according to ISO 9001, OHSAS 18001, and 14001 are the basis for the continuous improvement of our performance. Third party approvals for GF ABS offer peace of mind to customers using the products.



GF ABS is approved under regulation 31 of the Water Supply (Water Quality) Regulations 2000 for use in public water supplies and listed in the 'List of Approved Products and Processes' published by the DWI.

## + Distribution, Warehousing and Technical Support

The excellent location of the UK Distribution Centre in Coventry offers the latest in state of the art distribution and warehousing systems. An enhanced delivery system and a comprehensive warehousing programme guarantees prompt delivery to GF customers nationwide.

Our Technical support staff are qualified to offer you advice and guide you through the wealth of products GF can supply. We make sure you feel confident that the product matches your requirements and leaving you fully assured that GF is your preferred supplier.



GF Fleet of delivery vehicles



Tracking delivery of your order



## + ABS Piping System

The specific properties of ABS allow its application in a wide temperature range from -50 °C to +60 °C. The exceptionally high notched impact strength values, even at low temperatures indicate the material's high robustness and tolerance to surface damage. The ABS piping systems is an energy-efficient solution for industrial applications in the low temperature range such as refrigerating and cooling systems.

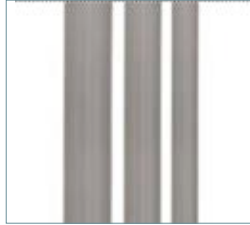

Pipes



Fittings



Jointing technology



Valves



Measurement & Control

### Essential system properties

- Outstanding abrasion resistance
- Low thermal conductivity
- High impact strength even at low temperatures
- Halogen free
- Safe and simple jointing technology with low costs for tools and materials

### Fields of application

- Water treatment
- Marine
- Cooling

### Technical data

Nominal pressure	Up to 15 bar
Temperature range	-50 °C to +60 °C
Joining technology	Solvent cementing
Standards and guidelines <sup>1)</sup>	ISO, EN ISO, BS, DIN, DVS

1) For additional information about standards, guidelines and approvals, see [www.gfps.com/uk](http://www.gfps.com/uk)

## + ABS product overview

The following table uses metric units of measure

Products	PN (bar)	d (mm)																										
		DN (mm)	10	15	20	25	32	40	50	63	75	90	100	110	125	140	150	160	180	200	200	225	250	250	280	300	315	
	10																											
Pipes	6																											
	16																											
Fittings	10																											
Ball valves	6																											
Butterfly valve	10																											
Check valves	10																											
Diaphragm valves	10																											
Flanges																												
Gaskets and pipe clips																												
Automation																												

The following table uses BS inch system units of measure

Products	PN (bar)	d (mm)												
		¾"	½"	¾"	1"	1 ¼"	1 ½"	2"	2 ½"	3"	4"	5"	6"	8"
	15 - class E													
	12 - class D/T													
Pipes	9 - class C													
Fittings	15 - class E													
Ball valves	16													
Butterfly valve	10													
Diaphragm valves	10													
Flanges														
Gaskets and pipe clips														
Automation														

For more information about the system specification of ABS, visit [www.gfps.com/uk](http://www.gfps.com/uk)



## + Acrylonitrile-butadiene-styrene (ABS)



### ABS properties (reference values)

Property	Value <sup>1</sup>	Units	Test standard
Density	≥ 1.035	g/cm <sup>3</sup>	EN ISO 1183-1
Yield stress at 23 °C	≥ 40	N/mm <sup>2</sup>	EN ISO 527-1
Tensile e-modulus at 23 °C	≥ 1800	N/mm <sup>2</sup>	EN ISO 527-1
Charpy notched impact strength at 23 °C	42	kJ/m <sup>2</sup>	EN ISO 179-1/1eA
Charpy notched impact strength at -40 °C	≥ 10	kJ/m <sup>2</sup>	EN ISO 179-1/1eA
Heat distortion temperature HDT A 1.80 MPa	≥ 74	°C	EN ISO 75-2
Vicat-heat distortion temperature B/50N	≥ 94	°C	ISO 306
Thermal conductivity at 23 °C	0.17	W/m K	EN 12664
Water absorption at 23 °C	≤ 0.45	%	EN ISO 62
Colour	similar 7001	-	RAL
Limiting oxygen index (LOI)	19	%	ISO 4589-1

<sup>1</sup> Typical characteristics measured at the material should not be used for calculations.



### General

Acrylonitrile-butadiene-styrene (ABS) is a versatile polymer. In addition to its application in piping systems, ABS is mainly common in automotive applications and in high-quality household devices. The wide area of application relates to the versatile characteristic profile of ABS which can be adapted to the respective application by taking advantage of the variable composition of the components acrylonitrile, styrene and polybutadiene. ABS belongs to the amorphous thermoplastics. While acrylonitrile provides strength to the material and contributes to an improved chemical resistance relative to polystyrene, the styrenic component provides both strength and a quality surface finish. On the other hand, the chemically bound polybutadiene rubber components give the material its impact strength, even at very low temperatures. The ABS used by GF Piping Systems shows a good balance between toughness and strength, making it especially suitable for low temperature applications. Accordingly, the areas of application are mainly refrigeration and airconditioning systems as well as water treatment.

### Advantages of ABS

- High impact strength even at low temperatures
- Corrosion resistance
- Simple installation via solvent cement joints
- Low thermal conductivity
- Halogen free
- Non-toxic
- Biologically inert; no support of microbial growth
- Low weight
- Low pressure losses due to smooth surfaces
- Good abrasion resistance
- Trouble-free recycling



### UV and weather resistance

If the ABS piping system is exposed to direct sunlight over a long period, its surface loses its shine and the colour shifts to light grey. Due to the very high impact strength of ABS, the resulting loss of toughness generally causes no problems in moderate climate zones. For extreme weather conditions or very high loads on the piping system, we nevertheless recommend protecting the surface from direct sunlight.



### **Abrasion resistance**

In addition to the excellent impact strength, the butadiene rubber components in ABS effect an outstanding resistance to abrasive stress. Because of this property, piping systems made of ABS have been used for solids and media containing solids, such as those found in mining, for a long time. ABS offers significant advantages for many of such applications compared to metals.



### **Application limits**

The application limits of the material on the one hand depend on embrittlement and softening temperatures and on the other hand on the nature and the expected service life of the application. The pressure-temperature diagrams give details on application temperatures and pressures.



### **Combustion behaviour**

ABS self-ignites at temperatures exceeding 450 °C. ABS burns when exposed to an open flame, after removing the flame, the material continues burning. The oxygen index amounts to 19 %. With an oxygen index below 21 %, ABS is considered to be flammable.

According to UL-94, ABS has an HB (horizontal burning) flammability coefficient and falls into building material class B2 (conventional inflammable, non-dripping) according to DIN 4102-1.

As a rule, toxic substances are released though all burning processes. Carbon monoxide is generally the combustion product most dangerous to humans. When ABS burns, primarily carbon dioxide, carbon monoxide and water are formed. Tests have shown that the relative toxicity of the products of combustion are similar or even lower than those of natural products such as wood, wool and cotton. ABS combustion gases are not corrosive. Nevertheless, the burning forms soot. Because of this, smoke develops during combustion.

Water, foam and carbon dioxide are suitable fire-fighting agents.



### **Electrical properties**

Like most thermoplastics, ABS is not conductive. This means that no electrochemical corrosion takes place in ABS systems. However, the non-conductive properties have to be taken into account because an electrostatic charge can develop in the piping. ABS provides good electrical insulation properties. The specific volume resistance is  $3.5 \times 1,016 \Omega\text{cm}$ , the specific surface resistance is  $1,013 \Omega$ . These figures have to be taken into account wherever there is a danger of fires or explosion.



### **Physiological properties**

Formulations of ABS used by GF Piping Systems are in general non toxic and biologically inert. For details regarding existing approvals for applications with drinking water or foodstuffs, please contact your GF Piping Systems representative.

# + Design of metric industrial piping systems

## Range of applications for pipes and fittings

### Pressure-temperature diagram for ABS

The following two pressure-temperature diagrams for ABS pipes and fittings are valid for a service life of 25 years. The design factor of 2.1 for BS inch systems and 1.8 for metric systems recommended by GF Piping Systems has been incorporated.

The diagram can be used for water or media resembling water, in other words, media that have no reduction factor for their chemical resistance.



Please take into account the pressure-temperature diagrams for valves and special fittings. Because of the construction and/or sealing material used, differences are possible when compared to pipes and fittings. More information is available in the Planning Fundamentals of the relevant types of valves and special fittings.



The influence of the anti-freeze compound has to be taken into account when calculating the allowable operating pressure. For example when using ethylene glycol <=50% aqueous a de-rating factor of 1.7 must be applied. Contact your authorised GF Piping Systems representative for additional information.

According to the 10°C curve in the Long-term behaviour for ABS, the following information applies to the temperature range from -50 °C to +60 °C

System	PN6	PN10	PN16
Permissible pressure	7.5 bar	11.8 bar	Max. 16 bar

Inch systems

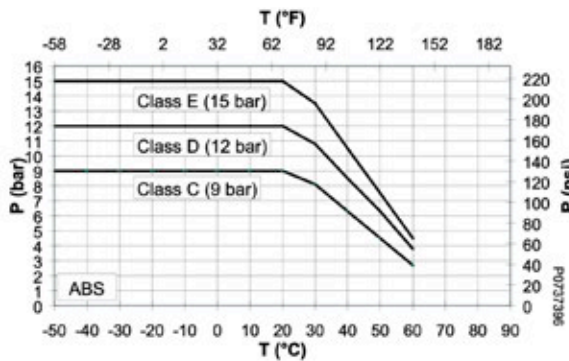

Metric systems

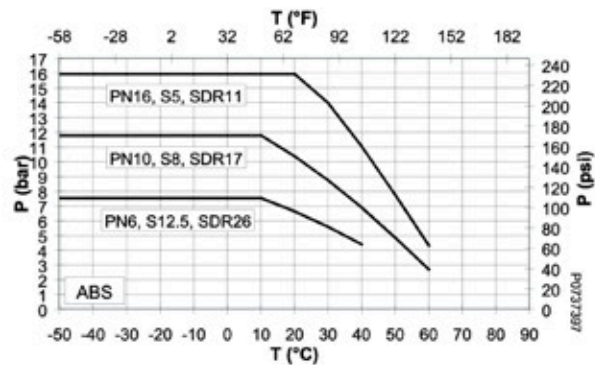

P Permissible pressure (bar, psi)  
T Temperature (°C, °F)

## + Jointing Technology

### Solvent cement jointing using Tangit

#### Overview -Material/cement



#### Requirements and information



Solvent cement jointing calls for adequate technical know-how, which can be acquired in the appropriate training courses. Your authorised GF Piping Systems representative will be happy to provide information about training options.



For the correct selection of the cement, observe the information on chemical resistance for the use of Tangit cement. For more information, see [www.gfps.com/tools](http://www.gfps.com/tools).



Always obey the safety regulations issued by the responsible authorities, as well as information in the safety data sheet. The current safety data sheet is available at [www.gfps.com/uk](http://www.gfps.com/uk) download centre.

#### Protective measures before cementing

##### Adequate ventilation of the workplace

Tangit cement and Tangit cleaner contain highly volatile solvents. This makes good ventilation or adequate fume extraction essential in closed spaces. Since the solvent fumes are heavier than air, extraction must occur at floor level, or at least below the working level. Place paper that has been used for cleaning or for the removal of surplus cement into closed containers to avoid of solvent fumes in the air.

##### No open flames when cementing. No smoking.

Cement and cleaner are flammable. Extinguish open flames before starting work. Switch off electric devices without explosion protection, electric heaters, etc. Avoid electrostatic charges. Discontinue any fusing operations. Furthermore, observe all instructions issued by the solvent cement manufacturer (e.g. label on the can and supplementary documentation).

##### Protection against spilled liquids

Pipes and fittings must be kept away from spilled cement, cleaner and used paper. Cement and cleaner that are no longer needed must be disposed of in an environmentally sound manner.

##### Use of gloves and protective glasses

The use of protective gloves is recommended to avoid cement or cleaner contact with the skin. If the cement or the cleaner come in contact with your eyes, rinse immediately with water. Consult a doctor! Immediately change clothes that have cement on them.

## Required tools and equipment



No.	Description	Dimensions	GF Code
1	Pipe cutter	d10–d63 mm	790109001
		d50–d110 mm	790109002
		d110–d160 mm	790109003
2	Chamfer device	d16 - 200mm d63 - 400mm	790309003 790309004
3	Deburring device	Commercially available	
4	Can lid	–	799298028
5	Tangit cement	ABS 0.65 kg can	799298022
6	Screwdriver or wooden spatula	Commercially available	
7	Round brush $\varnothing$ 4 mm Round brush $\varnothing$ 8 mm Flat brush 1", 25 x 3 mm Flat brush 2", 50 x 5 mm Flat brush 3", 75 x 6 mm	Fitting 6–10 mm	799299001
		Fitting 12–32 mm	799299002
		Fitting 40–63 mm	799299003
		Fitting 75–225 mm	799299004
		Fitting 250–400 mm	799299005
8	Tangit PVC-U, PVC-C, ABS cleaner	1 litre can	799298010
9	Marking pen	–	
10	White, absorbent, lint-free paper	Commercially available	
11	Folding ruler	Commercially available	
12	Solvent-resistant safety gloves	Commercially available	
13	Protective glasses	Commercially available	

## Dimensions and tolerances

The dimensions of pipes, fittings and valves made of ABS by GF Piping Systems generally conform to the standards EN ISO 15493 and EN ISO 1452-3. They can be connected with any fittings and valves made of the same material that have also been produced based on these standards.

## Required amounts of Tangit cement

Diameter (d)	Tangit(kg/100 connections)	Amount(g/joint)
20	0.25	2.5
32	0.40	4.0
40	0.55	5.5
50	0.70	7.0
63	1.10	11.0
75	1.50	15.0
90	2.50	25.0
110	4.10	41.0
140	6.00	60.0
160	8.00	80.0
200	13.00	130.0
225	20.00	200.0
315	40.00	400.0



The amount of cement used depends on a variety of factors. The table provides average values. It is generally not necessary to exceed these values.

## Cementing

Cementing should be performed at an ambient temperature of 5 °C to 35 °C.



### 1. Cutting the pipe to length

Cut off the pipe at a right angle by using a pipe cutter



### 2. Chamfering the pipe

Chamfer the end of the pipe with the chamfer device according to the following figure and table to enable a perfect cementing joint.

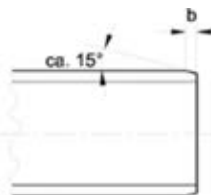

d (mm)	b (mm)
6 - 16	1 - 2
10 - 55	2 - 3
63 - 225	3 - 6
250 - 400	6 - 8



Well-chamfered pipe ends prevent the layer of cement from being removed as the pipe is inserted into the fitting.





### 3. Deburring the pipe

Debur the inside of the pipe with a deburring device.



### 4 Cleaning the pipe and fitting

First, remove any coarse dirt from the cementing surfaces (outside of pipe, inside of fittings). Clean the cementing surfaces thoroughly with Tangit PVC-U/PVC-C/ABS cleaner and paper. Always use a fresh piece of paper for each component. Remove any condensation that may have formed on the parts.

Pipes may have a waxy surface. To ensure proper jointing in such a case, the cleaning process must be repeated until the pipe surface becomes visibly matt.

Mechanical machining of the pipe surface may be necessary in individual cases. An indication of expected inadequate jointing quality is an absent or insufficient adhesion of the jointing parts following fine cleaning ("finger-nail check"). The jointing surfaces should then be roughened evenly with emery cloth of grain 80 or finer, observing the maximum permitted gaps.



**The cementing surfaces must be dry and free from grease and dirt, and must not be touched after cleaning.**



### 5 Marking the insertion depth

Mark the cementing length of the fitting on the pipe end using the folding rule and marking pen; this allows for checking the required application of adhesive and whether the pipe has been completely inserted.

Calculating the insertion depth:

$$t = \frac{d}{2} + 6$$

t Insertion depth (mm)

d Pipe diameter (mm)



**If the outside diameter of the pipe and the inside diameter of the socket are at opposite extremes of their tolerances, then the pipe cannot be inserted dry into the fitting socket. Insertion will only become possible once the cement has been applied.**



### 6 Checking the cement

Tangit cement is supplied ready for use. Stir thoroughly with a screwdriver or wooden spatula prior to use! Cement of the correct consistency will run evenly from a wooden spatula held at a slant. Cement that no longer runs smoothly is unusable. The cement must not be thinned since thinning would falsify the mixing ratio.



## 7. Applying the cement

Using firm brush pressure, apply an even, closed cement layer brushing in axial direction, first in the fitting, then on the pipe. Use a thin layer of cement in the fitting. To avoid subsequent bead formation inside the pipe, apply a generous amount on the pipe end.



**Starting at d75, two people are needed to apply the cement to the pipe end and fitting socket simultaneously in order to avoid exceeding the maximum opening time of the cement.**



**Starting at d250, the cement is poured directly from the can into the middle of the cementing surface and distributed first radially and then axially over the entire area with a flat brush until an even, closed layer is present. The minimum layer thickness in the fitting area is 1 mm, while a heavier coat is applied at the pipe end. Cementing in these dimension ranges must be performed by at least 2 persons.**



## 8 Connecting pipe and fitting

Immediately push pipe and fitting together to the stop or the full length of the socket (check insertion depth on the pipe) without twisting or misalignment and hold in position for a few seconds until the cement has set.



**Starting at d250, push pipe and fitting together and align them by using 3 to 4 persons. Hold the joint in this position for 1 minute must be performed by at least 2 persons.**



## 9 Checking and removing surplus cement

After jointing, a complete bead must be visible on the inside (smaller) and outside (larger).

Immediately wipe off any surplus cement using clean, absorbent paper.



**Jointing faces must be kept clean.**



**Important note: Cement and cleaner should be stored in a cool, dry place (5 to 35 °C)! Under these conditions, the cement and cleaner can be used for 24 months starting from the date of filling (imprinted on the can).**

**Cans not in use should be closed immediately to prevent solvent losses and thickening. The brush lid can be used, which allows for leaving the brush in the can of cement.**

Since both cement and cleaner dissolve the material, pipes and fittings must not be laid on or allowed to come into contact with spilled cement or paper containing cement residues.

Thickened cement sticking to the brush using dry paper and then rinse the brush with cleaner. Cleaned brushes must be dry before reuse.

### Flushing before putting into operation

After the drying process (see table in the section "Waiting time and pressure test") the pipelines can be filled. To remove remaining solvent vapour, the pipeline must be thoroughly flushed before putting it into operation. For pipes that are not put into operation immediately, we recommend filling them with water and flushing them regularly after careful cleaning. Do not use compressed air for flushing

## Tangit ABS



Charge/Batch-No.: \_\_\_\_\_

Abfülldatum/Filling date: \_\_\_\_\_

Diese Chargenzeichnung ist auf dem Prüf-/Abnahmeprotokoll anzubringen. / Put this product identification on the final test report.

### Documenting Tangit batch for ABS cementing

To ensure the traceability of the Tangit batch(es) used, if needed, document the batch identification attached to every shipped unit to the test/acceptance report. If several batches are used in one project, add one identification from each batch to the test report.

### Waiting time and pressure test

The length of the drying period before the joint may be subjected to testing or operating pressure depends on the drying temperature, the dimension and the fit requirements, as well as ambient influences.

The following table shows the corresponding waiting times and pressure test.

Materials and dimension	Temperature: 10 °C - 30 °C			Temperature: <10 °C / >30 °C		
	Between cementing	Operating pressure repair	Pressure test water max. 1.5 x PN	Between cementing	Operating pressure repair	Pressure test water max. 1.5 x PN
<b>ABS</b>						
< d160	10 min	1 h/bar	24 h	15 min	2 h/bar	48 h
d160-225	30 min	2 h/bar	24 h	60 min	4 h/bar	48 h
d250-315	60 min	4 h/bar	48 h	120 min	8 h/bar	72 h

Actual values at the construction site may deviate. These are empirical values.

### Internal pressure test or leak tightness test of ABS with gas/air

Due to the risk of a pressure test with a compressible test medium, this pressure test should be carried out only in exceptional cases. The following diagram shows the required waiting times depending on the test pressure for ambient temperatures between 10 and 30 °C:

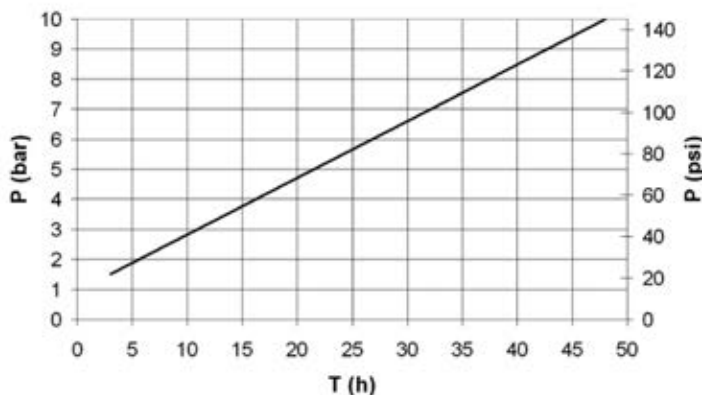

P Test pressure (bar, psi)  
 T Waiting time after last cementing (h)  
 Ambient temperature from 10 to 30 °C

### Disposal

Dried product residues can be added to household or industrial waste. Large quantities must be disposed of separately. Empty packaging can be added to recycling.

# + Installation of metric industrial piping systems

## Change in length and flexible sections Introduction

### General

Thermoplastics are subject to greater thermal expansion and contraction than metals. Pipes installed above ground, against walls or in ducts, especially those exposed to temperature variations, require changes in length to be taken up in order to prevent extra strain on the pipes. Length changes can be taken up by:

- a) flexible sections
- b) compensators

Flexible sections are the most common solution, being the simplest and the most economical. The calculations for and the positioning of flexible sections are therefore described in detail.

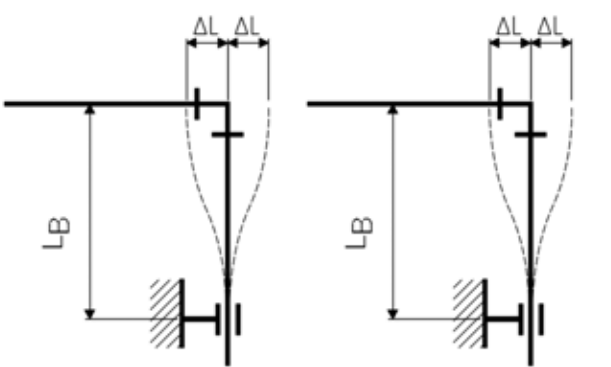

### Fundamentals

The low modulus of elasticity of thermoplastics allows changes in length to be taken up by special pipe sections, where pipe supports are positioned so that they can take advantage of the natural flexibility of the material. The length of such sections is determined by the diameter of the pipeline and the extent of the thermal expansion to be compensated. Flexible sections arise naturally at any branching or change in direction of the pipeline. The movement LB of the flexible section as a result of a change ΔL in the length must not be restrained by fixed pipe brackets, protrusions wall, girders or the like.

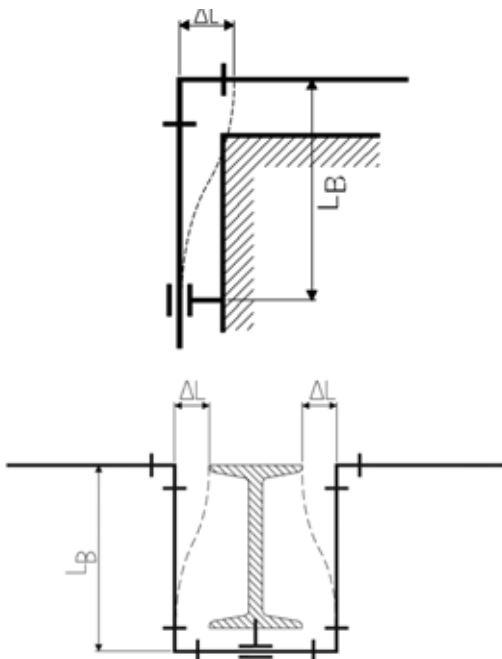

### Calculation of change in length

The **change in length caused by temperature** can be calculated using the following formula:

$$\Delta L = L \Delta T \alpha$$

with:

- ΔL = temperature-related change in length (mm)
- L = length of the pipe section (m)
- ΔT = difference of temperature (K)
- α = coefficient of linear expansion (mm / m K)

### Coefficients of linear expansion of polymers:

Material	α in mm/m K
ABS	0.10

\* Exact values can be calculated using GF's online tool or ask your local representative



**Tip:** If the operating temperature is higher than the installation temperature, then the pipe expands. If, on the other hand, the operating temperature is lower than the installation temperature then the pipe contracts in length.

The installation temperature must therefore be incorporated into the calculations as well as the maximum and minimum operating temperatures. It is preferable to use "+" to indicate expansion of the pipe and "-" to indicate contraction.

The larger change in length is the one to be used for determining the required length of the flexible section.

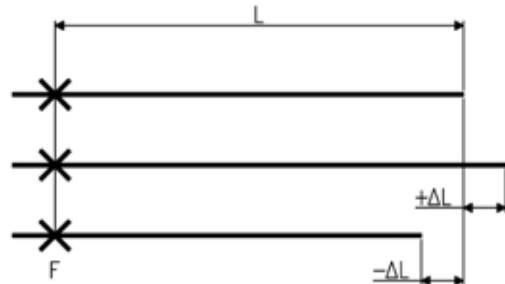

The length of the flexible section for each change in length, ΔL, can be determined from the following formula:

$$a = c \cdot \sqrt{(d \cdot \Delta L)}$$

a = flexible leg (mm)  
 c = constant  
 d = pipe outside diameter (mm)  
 ΔL = expansion or contraction (mm)

Material	c
ABS	32.7

### Boundary conditions for using the diagram

For easy determination of the required length of flexible section please use the following diagrams. Please take into account the given boundary conditions.

- Assembly temperature  $T_M = 20\text{ °C}$
- $T_B$  Operating temperature
- $\Delta T = T_B - T_M$
- allowable bending stress 15 % of  $\sigma_v$
- PN 6 .. 16
- Coefficient of friction of the pipe in the loose brackets  $\leq 0.5$

### Information:

The following diagrams show the required flexible sections for straight pipe lengths of 10 m or 70 m. Exceeding the maximally permissible straight pipe distance would lead to buckling of the pipe due to the too large friction in the pipe clamps. Therefore the maximally possible pipe length is to consider depending on the pipe diameter =>above the hatched range.

### Example: Determining the required flexible section

#### Calculating the relevant change in length

The example of an ABS process pipe serves to illustrate the procedure:

Length of piping from the fixed point to the branch point where the change in length is to be taken up:

- $L = 8\text{ m}$ .
- Installation temperature:  $T_M = 20\text{ °C}$
- Max. working temperature:  $T_1 = 35\text{ °C}$
- Min. working temperature:  $T_2 = -20\text{ °C}$

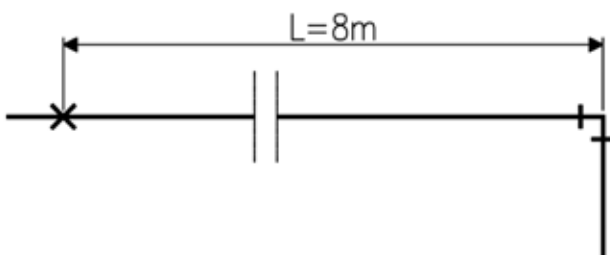

Expansion of the section during heating  
 $+\Delta L_1 = L \cdot \Delta T_1 \cdot \alpha = 8 \cdot 15 \cdot 0.10 = 12\text{ mm}$

Contraction during cooling  
 $-\Delta L_2 = L \cdot \Delta T_2 \cdot \alpha = 8 \cdot 40 \cdot 0.10 = 32\text{ mm}$

Temperature differences

$$\Delta T_1 = T_1 - T_M = 15\text{ °C}$$

$$\Delta T_2 = T_2 - T_M = -40\text{ °C}$$

Maximum change in temperature chosen

$$\Delta T = 40\text{ °C}$$

### Determining the length of the flexible section for ABS

The values needed to determine the necessary length are:

- The maximum change in temperature from the 0-position (i. e. from the position in which the pipe was installed). But remember that the pipe could just as well contract as expand.
- The pipe diameter  $d$ .
- The length of the pipe section  $L$ .

With these values the required length of the flexible section can be read off from the diagram for ABS.

Continuing with the example introduced before and supposing that an ABS pipe with  $d = 50\text{ mm}$  is installed, the maximum change in temperature being  $\Delta T = 40\text{ °C}$ , the required length of the flexible section is seen directly from the diagram to be  $L_B = 1300\text{ mm}$ .



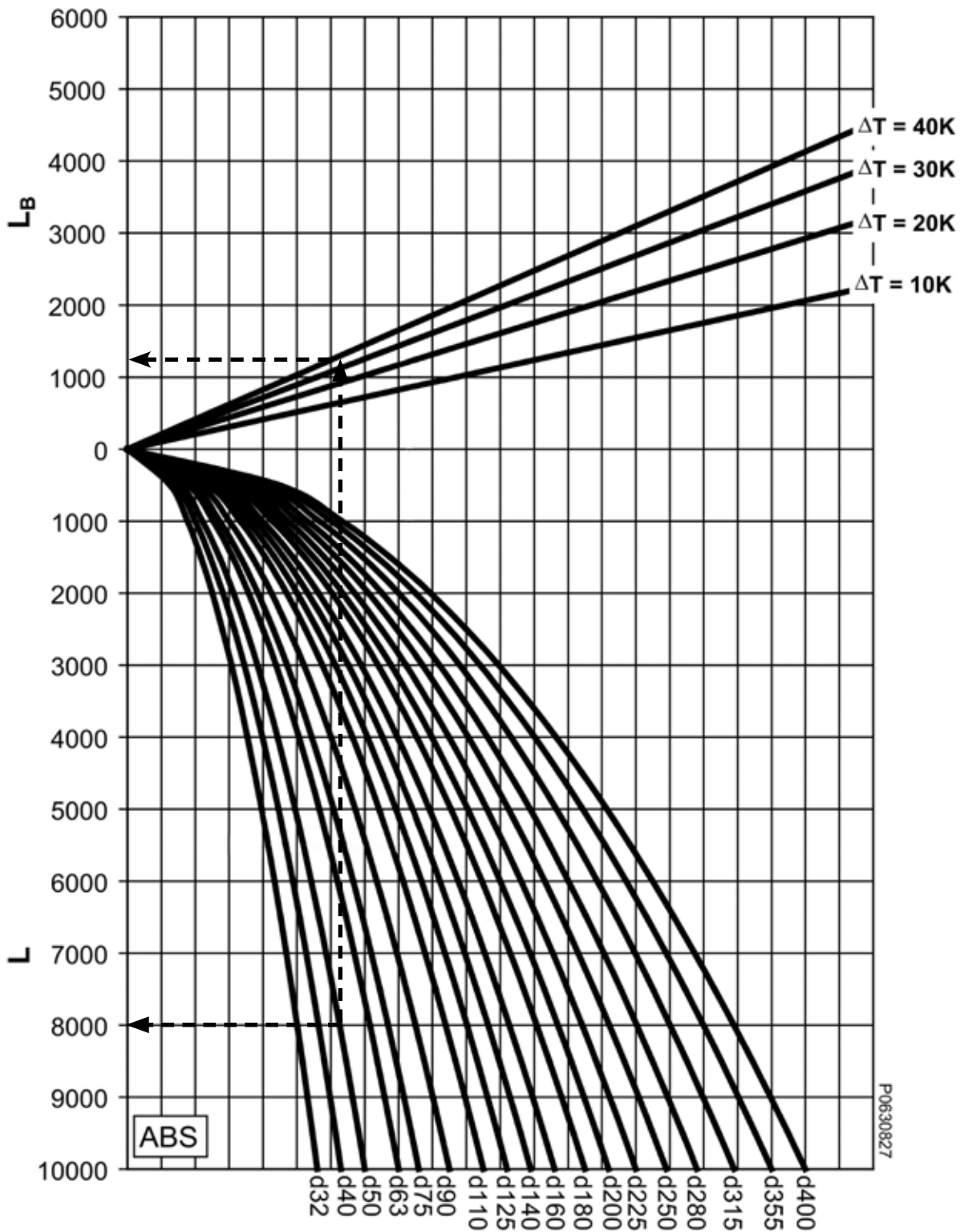

L Length of the pipe section in mm  
 $L_B$  Required length of flexible section in mm



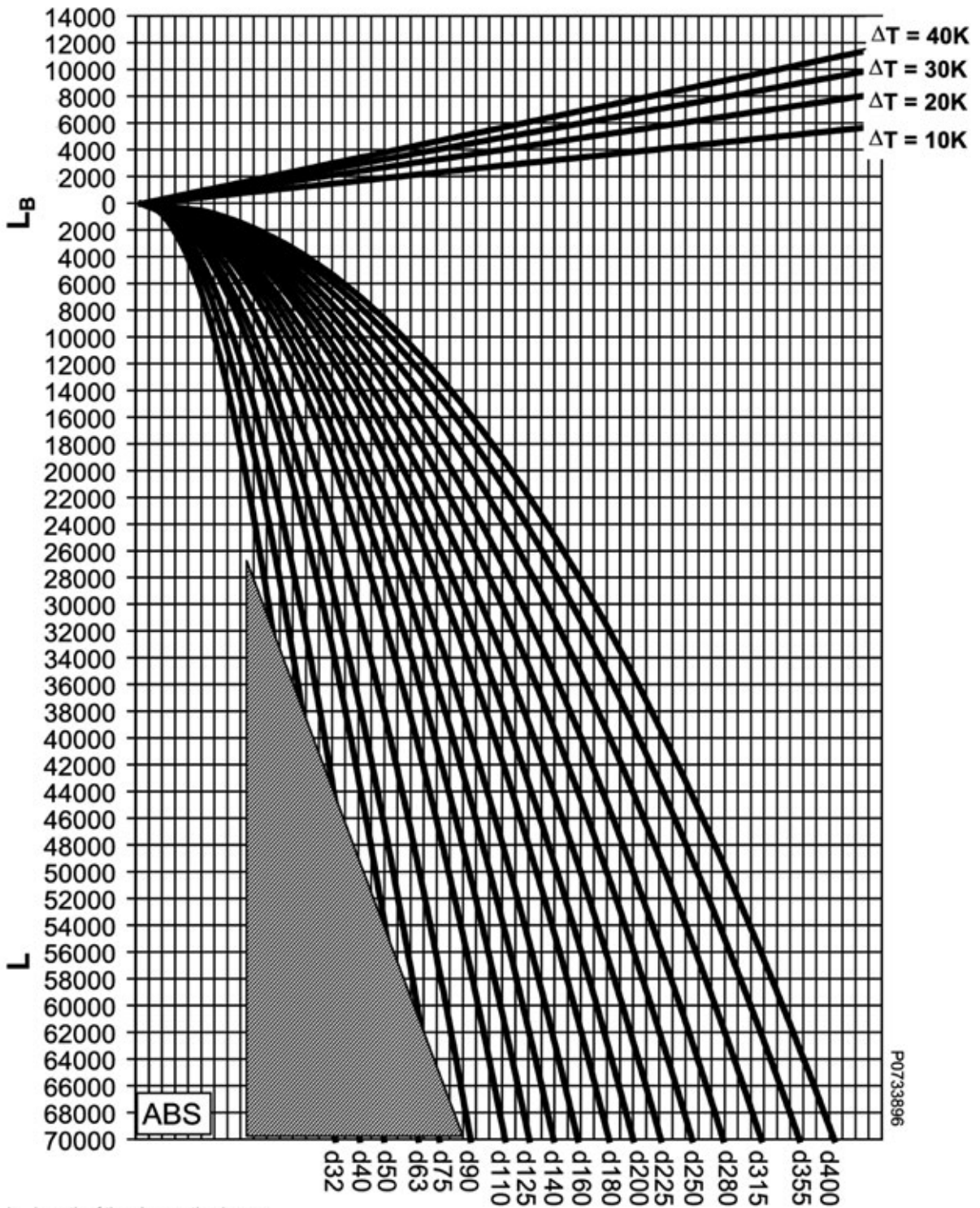

L Length of the pipe section in mm  
 $L_B$  Required length of flexible section in mm  
 Remark: Please observe the explanations to the hatched area in the clause boundary conditions

## + Installation of metric industrial piping systems

### Recommendations for installation

Length changes in pipe sections should always be accommodated through the arrangement of fixed brackets. The following examples show how the changes can be distributed in pipe sections by suitable positioning of fixed brackets.

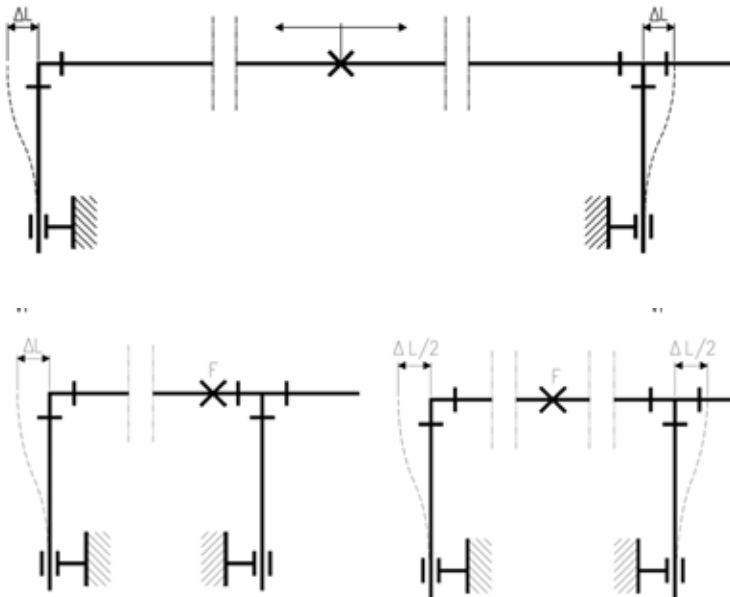

not recommended

recommended

Expansion loops can be installed to take up changes in length when flexible sections cannot be included at a change in direction or branch in the pipeline or if substantial changes in the length of a straight section need to be taken up. In such a case the compensation for changes in length is distributed over two flexible sections.

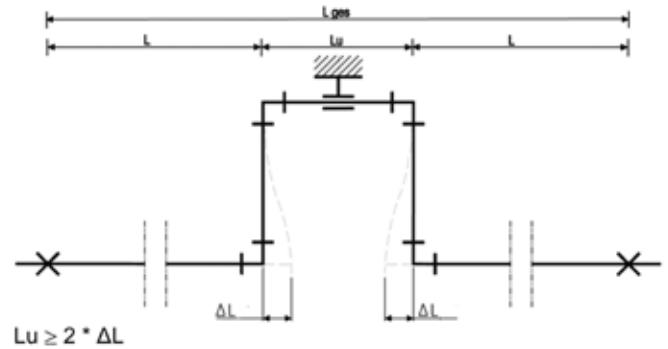

### NOTICE

#### Bending load at flexible sections

Caused by the bending load leakages can occur at mechanical joints.

- Within the range of flexible sections and/or expansion loops no screw connections or flange connections shall be used.

### Pre-stress

Length changes in pipe sections should always be accommodated through the arrangement of fixed brackets.

The following examples show how the changes can be distributed in pipe sections by suitable positioning of fixed brackets.

Installation data:  $L = 10\text{m}$   
 $d = 50\text{mm}$   
 Installation temperature:  $15^\circ\text{C}$   
 Max. operating temperature:  $40^\circ\text{C}$   
 Material: ABS

#### a) Change in length

$$+\Delta L = L * \Delta T * \alpha_{\text{ABS}} = 10 * 25 * 0.10 = 25 \text{ mm}$$

b) A flexible section to take up a change in length of  $\Delta L - 25\text{mm}$  needs to be  $L_B = \text{approx. } 1150\text{mm}$  long according to the diagram.

c) If the flexible section is pre-stressed to  $\Delta L/2$  then the required length of the flexible section is reduced to about  $800\text{mm}$ . The variation length from the 0 position is then  $\pm\Delta L/2 = 25/2 = 12.5\text{mm}$ .

Pre-stressing the flexible section makes it possible to reduced its required length in installations where space is restricted. Pre-stressing also reduced the bending of the flexible section in service, improving the appearance of the pipeline.

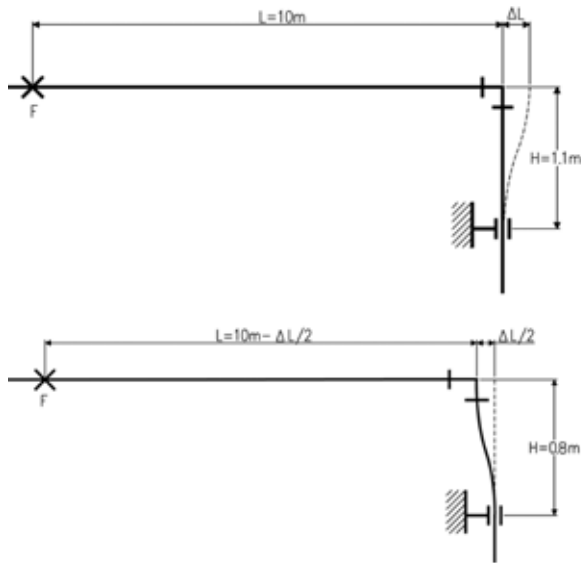

### Installing compensators

The low modulus of elasticity means that the reaction force of plastic pipes to thermal changes is low compared to metal pipes. This makes normal compensators designed for use with metal pipes unsuitable because of their high inherent resistance. Only freely moving compensators may be used in plastic pipe systems, i. e. those with a low resistance. The following compensators may be considered: rubber compensators, PTFE corrugated compensators or suitably selected metal multi-disc compensators.

Carefully placed fixed points should be used when fitting compensators for the regulation of the pipe in order to ensure their unhindered operation. The installation temperature provides the basis for the calculations to ensure this.



**Tip:** When using compensators, additional longitudinal forces are implemented into the pipeline. These forces have to be carried by guiding the pipeline. For example, threaded rods are not suitable. To estimate the lateral forces it can be assumed that they can reach about 15% of the axial forces. Please contact the manufacturers of compensators for further support designing such pipelines

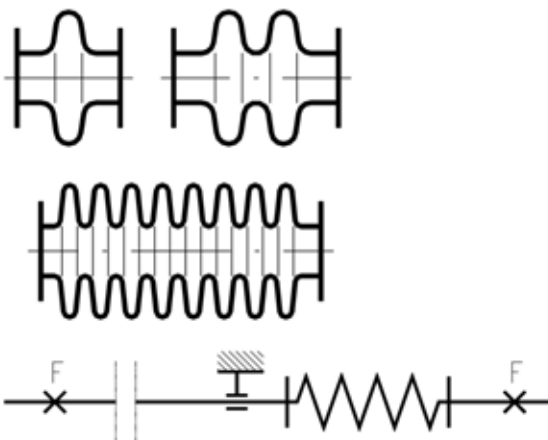

### Installing Valves

Valves should be secured as directly as possible, so that the actuation forces are transmitted directly and not via the pipeline. Valve brackets or valves from GF with an integrated fastening device are used to securely fasten plastic valves. These valve brackets are also used to bear the loads of the valve and filling weight of the pipeline. Any changes in length which arise can be prevented with the appropriate fixed points before or after the valve. You will find more information under the respective valve types.

### Installing pipework under plaster or embedding it in concrete

#### Installing Valves

Installing pipework under plaster or embedding it in concrete

#### Padded pipework

Where pipework is installed under plaster or embedded into concrete, the flexible sections at bends and branches must be padded for the calculated distance  $H$ , as also must any branches and elbows included in the affected section. Use only flexible materials as padding, such as glass wool, mineral wool, foam or similar.

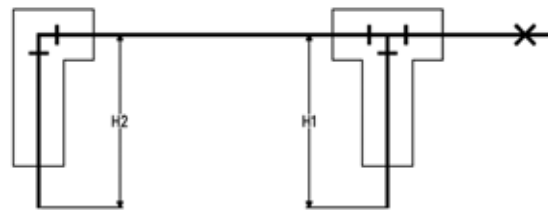

#### Unpadded pipework

Unpadded pipes can also be plastered or concreted in directly. Since the axial stress arising from internal pressure is half as great as the circumferential stress, pipelines can support limited additional axial stress without becoming overloaded. In such cases the level of stress expected must be calculated. The same is true of any section of pipe between two fixed points where no allowance has been made for changes in length. The load at the fixed points must be calculated and considered when planning the fixed points. The distance between pipe brackets in such cases may have to be reduced from the normal values in order to prevent bowing in the pipeline.

Care must be taken to avoid creating cavities when plastering or concreting in the pipeline, because under unfavourable conditions these can become areas of stress concentration.

A rich plaster mixture (1 : 3 to 1 : 4) should be used to allow the forces arising from temperature variations to be transmitted away without causing the plaster to crack.

## + Installation of metric industrial piping systems

### Pipe bracket spacing and support of pipelines

#### General

##### Pipe support for plastics pipes

Plastic pipe systems should be installed using supports designed for use with plastics and should then be installed taking care not to damage or over stress the pipe.

##### Arranging Loose Brackets

###### What is a loose pipe bracket?

A loose pipe bracket is a bracket which allows axial movement of the pipe, to allow stress free compensation of temperature changes and compensation of any other operating condition changes

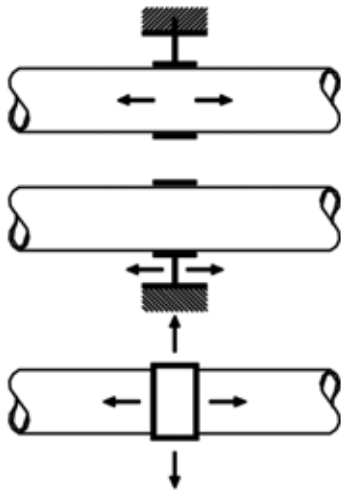

The inner diameter of the bracket should be larger than the outside diameter of the pipe to allow free movement of the pipe. The inner edges of the brackets should be free from any sharp contours which could damage the plastic. If the brackets' inside diameter is not larger than the pipe then the bracket should not be fully tightened, thus allowing the pipe to move.

Another method is to use brackets with spacers which also avoids clamping the bracket on the pipe.

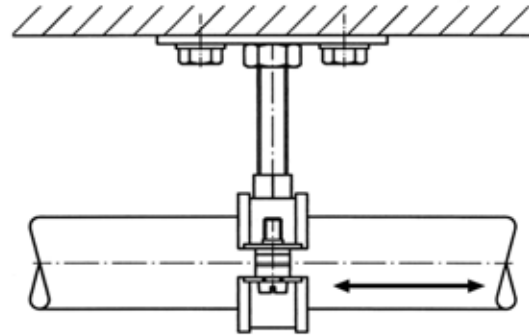

##### Spacer to avoid clamping

Axial movement of the pipeline must not be prevented by fittings placed next to pipe brackets or by any other component affecting the diameter of the pipe. Sliding brackets and hanging brackets permit the pipe to move in different directions. Attaching a sliding block to the base of the pipe bracket permits free movement of the pipe along a flat supporting surface. Sliding and hanging brackets are needed in situations where the pipeline changes direction and free movement of the pipe must be allowed.

##### Arranging fixed points

###### What is a fixed point?

A fixed pipe bracket is a bracket which prevents the pipe from moving in any direction. The aim of which is to control system stresses caused by temperature changes.

#### NOTICE

##### Construction of fixpoint

This should not be done by simply clamping the bracket onto the outside of the pipe! This can cause deformation and physical damage to the pipe, damage that sometimes only later becomes visible.

- It should be done either by using pipe brackets located between two fittings or a double bracket must be used. (double-sided fixed point).
- Placing a pipe bracket immediately adjacent to a fitting restricts movement due to changes in length to one direction (one-sided fixed point).

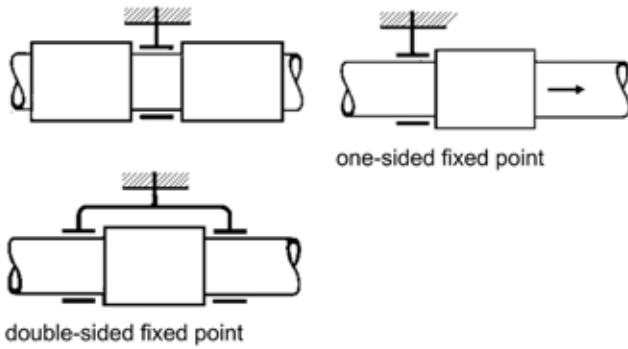

Starting from the dimension d90 the KLIP-IT brackets must be installed standing, like shown in the assembly examples. The support distances given in the following, specified for the KLIP-IT tubing clamps, apply only to this mounting method.

**Information:**

Pipe brackets must be robust and mounted firmly to be able to take up the forces arising from changes in length in the pipeline. Hanging brackets or KLIP-IT pipe brackets are unsuitable for use as fixed points.

**KLIP-IT pipe brackets**

These robust plastic pipe brackets can be used not only under rigorous operating conditions, but also where the pipework is subject to aggressive media or atmospheric conditions. They may be used for all materials of pipes. Don't use KLIP-IT pipe brackets as fixed points!

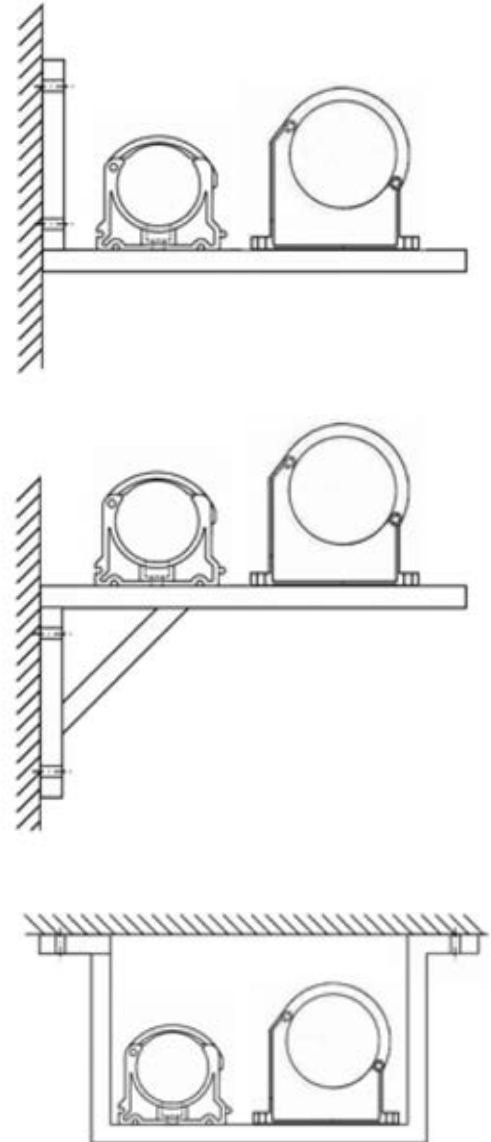



## Pipe brackets for cold insulation (MIP)

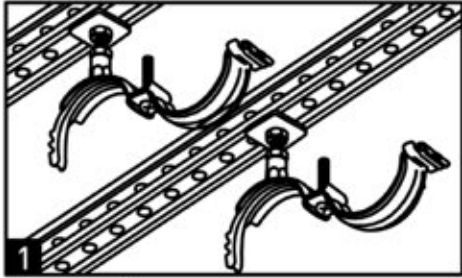

1 Open handle

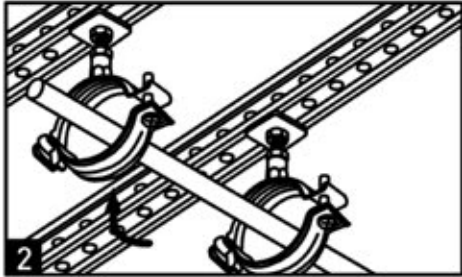

2 Insert pipe  
Close handle with quick-action clamp

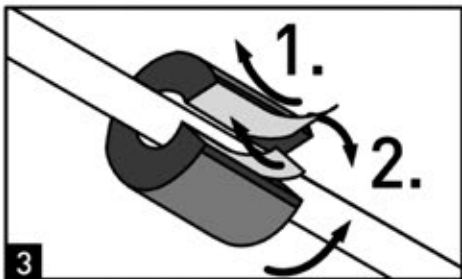

3 Assemble insulation  
1. Take off foil  
2. Press area of contact

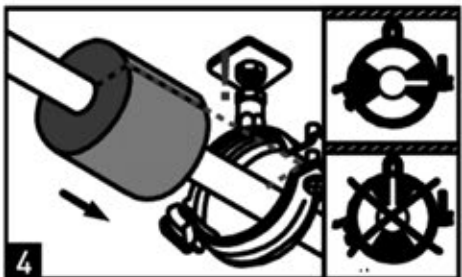

4 Move insulation into the bracket. Attention!  
Make sure the insulator is positioned correctly.

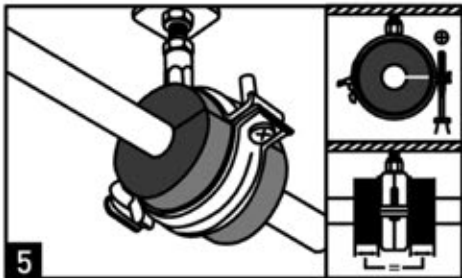

5 Tighten the screw

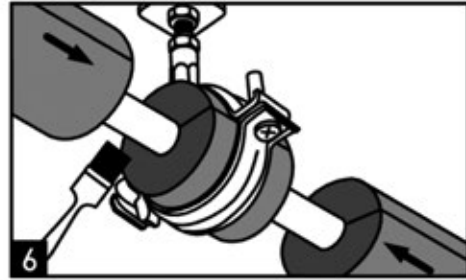

6 Coat areas of contact with adhesive and bond them

### Using the tables for pipe bracket spacing

Plastic pipelines need to be supported at certain intervals depending on several factors: the material, the average pipe wall temperature, the density of the medium transported and the size and wall thickness of the pipe. Determining the spacing between pipe brackets is based on the permissible deflection of the pipe between consecutive brackets.

### Information:

The values given in the tables apply only to pipelines which are freely movable in the axial direction.

Pipelines which are fastened tightly in the axial direction (fixed installations) must be checked for buckling. In most cases, this leads to a reduction of the maximum inner pressure and shorter distances between the support brackets.

Furthermore, the forces that act on the fixed points must also be taken into consideration.

For assistance, please contact your nearest GF representative.





## Pipe bracket spacing for ABS pipes

Liquids with a density of 1 g/cm<sup>3</sup>

d mm	DN inch	Pipe bracket intervals L for pipes PN10 / SDR17 / S8 or class C in mm at pipe wall temperature:				
		≤ 20 °C	30 °C	40 °C	50 °C	60 °C
16	3/8	700	650	600	550	450
20	1/2	800	700	650	600	500
25	3/4	850	800	750	650	600
32	1	1000	900	850	750	650
40	1¼	1100	1000	950	850	750
50	1½	1150	1100	1000	900	800
63	2	1300	1200	1100	1000	850
75	2½	1500	1350	1200	1100	950
90	3	1600	1450	1350	1200	1050
110	4	1800	1650	1550	1350	1200
140	5	2050	1800	1700	1400	1250
160	6	2200	1850	1750	1450	1300
200	7	2300	2050	1850	1550	1350
225	8	2400	2200	1900	1600	1450
250	9	2500	2300	2000	1650	1500
280	10	2650	2400	2100	1700	1600
315	12	2800	2500	2200	1800	1650

For other SDR / PN values or classes multiply the values given in the table with the following factor.

SDR11 / PN16 1.08

Class B 0.90

Class D 1.05

Class E 1.09

The pipe bracket spacing given in the table may be increased by 30 % in the case of vertical pipe runs, i. e. multiply the values given by 1.3.

### Fluids of a density other than 1 g/cm<sup>3</sup>

If the liquid to be transported has a density not equal 1 g/cm<sup>3</sup>, then the bracket spacings in the table above should be multiplied by the factor given in the following table.

Density of the fluid in g/cm <sup>3</sup>	Type of fluid	Factor for pipe bracket spacing
1.00	Water	1.00
1.25	Other	0.96
1.50		0.92
1.75		0.88
2.00		0.84
≤ 0.01	Gaseous	1.30

## + Abbreviations

AL	Number of bolt holes	PE	Polyethylene
ABS	Acrylonitrile Butadiene Styrene	PN	Nominal pressure at 20°C, water
ANSI	American National Standard Institute	PP	Polypropylene, heat stabilised
CR	Chloroprene Rubber e.g. Neopren	PTFE	Polytetrafluorethylene, e.g. Teflon®
d	Pipe outside diameter	PVC-C	Polyvinyl Chloride, chlorinated
DIN	German standard	PVC-U	Unplasticised Polyvinyl, chloride
DN	Nominal bore	PVDF	Polyvinylidene Fluoride
e	Wall thickness	R	Taper male thread, pressure tight in the thread to ISO 7
EPDM	Ethylene Propylene Rubber	Rp	Parallel female thread, pressure tight in the thread to ISO 7
FM	Fusion Method	®	Registered trade-mark
FPM	Fluorine Rubber, e.g. Viton®	s	Across flats
kg	Weight in kilograms	SAN	Styrene-acrylonitrile
G	Pipe thread, not pressure tight in the thread to ISO 288	SC	Size of hexagon bolts
HTR	High Temperature Resistant	SP	Standard pack. The figure given indicates the quantity of fittings contained in a standard pack
ISO	International Standardisation Organisation	St	Steel
Ms	Brass	Tg	Malleable iron
NBR	Nitrile Rubber	TM	Trade-mark
NPT	Taper male thread pressure tight in the thread to ANSI B 1.20.1	Tr	Trapezoid thread
PA	Polyamide	PP-GF	Polypropylene, glass fibre reinforced
PBTP	Polybutylene terephthalate		

# Table of contents

---

ABS Inch	4
ABS Metric	21
Valves	43
Accessories	105
Index	121

---





Pipes

3



Solvent Cement Fittings

5



Adaptor Fittings

10



Threaded Fittings

13



Flange Adaptors

15



Unions

16



Adaptor Unions

18





# Pipes

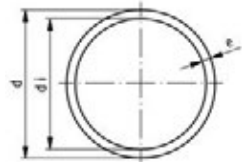

## Pipe ABS grey class E 15 bar at 20°C

- Dimensions: BS 5391
- Pipe length: 6m with plain ends
- Minimum order quantity: 1 length

d (inch)	PN (bar)	Code	Weight (kg/m)	e (mm)	di (mm)
¾	15	<b>169 018 080</b>	0.086	1.7	13.6
½	15	<b>169 018 081</b>	0.126	2.0	17.3
¾	15	<b>169 018 082</b>	0.198	2.5	21.7
1	15	<b>169 018 083</b>	0.313	3.1	27.2
1 ¼	15	<b>169 018 084</b>	0.494	3.9	34.4
1 ½	15	<b>169 018 085</b>	0.650	4.5	39.3
2	15	<b>169 018 086</b>	1.002	5.6	49.1
3	15	<b>169 018 088</b>	2.174	8.3	72.3
4	15	<b>169 018 089</b>	3.592	10.6	93.1

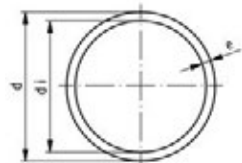

## Pipe ABS grey class D 12 bar at 20°C

- Dimensions: BS 5391
- Pipe length: 6m with plain ends
- Minimum order quantity: 1 length

d (inch)	PN (bar)	Code	Weight (kg/m)	e (mm)	di (mm)
6	12	<b>169 018 067</b>	6.503	12.8	142.7

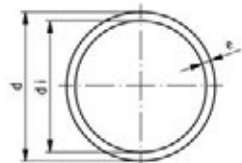

## Pipe ABS grey class C 9 bar at 20°C

- Dimensions: BS 5391
- Pipe length: 6m with plain ends
- Minimum order quantity: 1 length

d (inch)	PN (bar)	Code	Weight (kg/m)	e (mm)	di (mm)
1	9	<b>169 018 033</b>	0.206	2.0	29.4
1 ¼	9	<b>169 018 034</b>	0.325	2.5	37.2
1 ½	9	<b>169 018 035</b>	0.423	2.8	42.7
2	9	<b>169 018 036</b>	0.659	3.6	41.9
3	9	<b>169 018 038</b>	1.410	5.2	78.5
2 ½	10	<b>169 017 087</b>	1.154	4.5	66.0
4	9	<b>169 018 039</b>	2.339	6.7	100.9
5	10	<b>169 017 091</b>	4.083	8.3	122.8
6	9	<b>169 018 042</b>	5.123	9.9	148.5
8	9	<b>169 018 045</b>	8.566	12.7	193.7

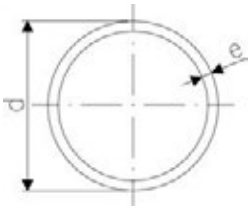

### Pipe ABS grey class 7 (T) 12 bar at 20°C

- Dimensions: BS 5391
- Pipe length: 6m with plain ends
- Minimum order quantity: 1 length
- Thick wall pipe to allow for threading

d (inch)	PN (bar)	Code	Weight (kg/m)	e (mm)	di (mm)
½	12	<b>169 018 106</b>	0.209	3.6	14.3
¾	12	<b>169 018 107</b>	0.272	3.6	19.7
1	12	<b>169 018 108</b>	0.415	4.3	24.7
1 ¼	12	<b>169 018 109</b>	0.640	5.3	31.0
1 ½	12	<b>169 018 110</b>	0.828	6.0	33.7
2	12	<b>169 018 111</b>	1.251	7.2	45.9

# Solvent Cement Fittings

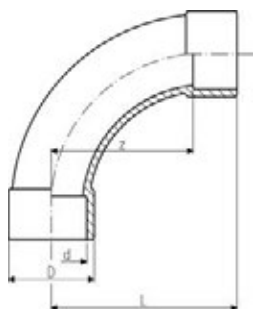

## Bend 90° ABS Inch BS

d (inch)	PN (bar)	Code	SP	Weight (kg)	z (mm)	D (mm)	L (mm)
½	15	<b>729 001 106</b>	10	0.021	40	29	58
¾	15	<b>729 001 107</b>	10	0.035	50	35	71
1	15	<b>729 001 108</b>	10	0.052	64	43	88
1 ¼	15	<b>729 001 109</b>	30	0.155	80	54	109
1 ½	15	<b>729 001 110</b>	5	0.236	100	64	131
2	15	<b>729 001 111</b>	5	0.388	126	76	163
2 ½	10	<b>729 000 112</b>	5	0.595	150	90	194
3	15	<b>729 001 113</b>	5	1.339	180	113	231
4	15	<b>729 001 115</b>	2	1.954	220	137	284

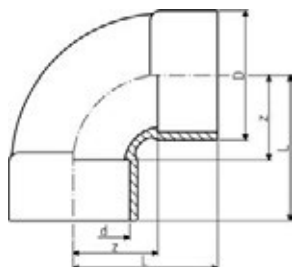

## Bend 90° short pattern ABS Inch BS

d (mm)	PN (bar)	Code	SP	Weight (kg)	z (mm)	D (mm)	L (mm)
8	9	<b>729 011 120</b>	1	6.112	168	256	287

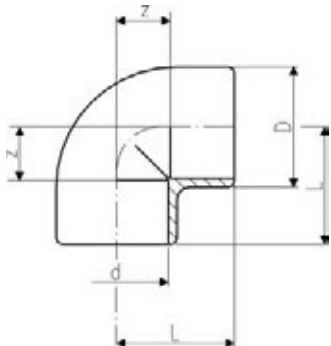

### Elbow 90° ABS Inch BS

d (inch)	PN (bar)	Code	SP	Weight (kg)	z (mm)	D (mm)	L (mm)
3/8	15	<b>729 101 105</b>	10	0.012	10	24	25
1/2	15	<b>729 101 106</b>	10	0.017	13	28	30
3/4	15	<b>729 101 107</b>	10	0.027	16	34	37
1	15	<b>729 101 108</b>	10	0.033	19	40	42
1 1/4	15	<b>729 101 109</b>	10	0.060	22	52	51
1 1/2	15	<b>729 101 110</b>	10	0.090	26	58	56
2	15	<b>729 101 111</b>	10	0.162	32	73	68
2 1/2	10	<b>729 100 112</b>	5	0.300	40	90	84
3	15	<b>729 101 113</b>	5	0.444	46	107	97
4	15	<b>729 101 115</b>	2	1.008	59	137	122
5	10	<b>729 100 116</b>	4	1.516	70	162	146
6	12	<b>729 101 117</b>	1	3.103	86	201	176

### Elbow 45° ABS Inch BS

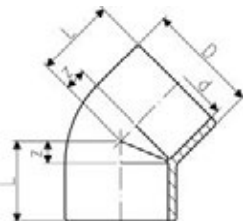

d (inch)	PN (bar)	Code	SP	Weight (kg)	z (mm)	D (mm)	L (mm)
3/8	15	<b>729 151 105</b>	10	0.006	4	23	20
1/2	15	<b>729 151 106</b>	10	0.010	7	28	24
3/4	15	<b>729 151 107</b>	10	0.015	8	33	29
1	15	<b>729 151 108</b>	10	0.027	10	41	33
1 1/4	15	<b>729 151 109</b>	10	0.046	11	51	40
1 1/2	15	<b>729 151 110</b>	5	0.068	11	57	41
2	15	<b>729 151 111</b>	10	0.134	15	72	51
2 1/2	10	<b>729 150 112</b>	5	0.225	17	89	61
3	15	<b>729 151 113</b>	5	0.407	21	109	72
4	15	<b>729 151 115</b>	5	0.714	26	135	89
5	10	<b>729 150 116</b>	1	1.175	32	162	108
6	12	<b>729 151 117</b>	2	2.700	38	198	129
8	9	<b>729 151 120</b>	1	3.893	49	250	168

### Tee 90° ABS Inch BS

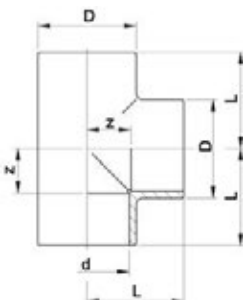

d (inch)	PN (bar)	Code	SP	Weight (kg)	z (mm)	D (mm)	L (mm)
3/8	15	<b>729 201 105</b>	10	0.018	10	25	25
1/2	15	<b>729 201 106</b>	10	0.028	13	30	30
3/4	15	<b>729 201 107</b>	10	0.039	16	35	37
1	15	<b>729 201 108</b>	10	0.061	19	43	43
1 1/4	15	<b>729 201 109</b>	10	0.075	22	53	51
1 1/2	15	<b>729 201 110</b>	5	0.152	26	58	56
2	15	<b>729 201 111</b>	5	0.307	32	73	68
2 1/2	10	<b>729 200 112</b>	6	0.404	40	90	84
3	15	<b>729 201 113</b>	5	0.703	46	107	97
4	15	<b>729 201 115</b>	2	1.417	59	138	122
5	10	<b>729 200 116</b>	1	2.570	71	169	147
6	12	<b>729 201 117</b>	1	4.470	86	202	176
8	9	<b>729 201 120</b>	1	7.754	114	256	233

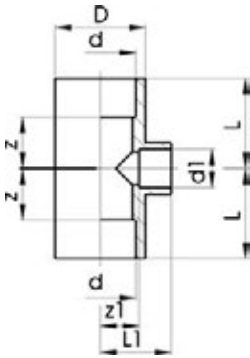

### Tee 90° reducing ABS Inch BS

d (inch)	d1 (inch)	PN (bar)	Code	SP	Weight (kg)	z (mm)	z1 (mm)	D (mm)	L (mm)	L1 (mm)
¾	½	15	<b>729 201 134</b>	10	0.026	14	14	33	33	30
1	½	15	<b>729 201 141</b>	10	0.042	17	17	41	39	33
1	¾	15	<b>729 201 138</b>	10	0.043	17	17	41	39	36
1 ¼	¾	15	<b>729 201 151</b>	1	0.110	30	22	53	51	51
1 ¼	1	15	<b>729 201 147</b>	0	0.120	27	22	53	51	51
1 ½	½	15	<b>729 201 009</b>	5	0.159	29	29	62	59	44
1 ½	1	15	<b>729 201 164</b>	5	0.158	29	25	62	59	50
2	¾	15	<b>729 201 011</b>	10	0.246	37	31	77	73	53
2	1	15	<b>729 201 178</b>	5	0.288	37	31	77	73	56
2	1 ½	15	<b>729 201 170</b>	0	0.265	38	31	73	68	68
4	3	15	<b>729 201 137</b>	0	0.001	72	59	138	122	122

### Tee 45° ABS Inch BS

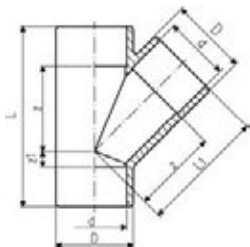

d (inch)	PN (bar)	Code	SP	Weight (kg)	z (mm)	z1 (mm)	D (mm)	L (mm)	L1 (mm)
½	9	<b>729 251 106</b>	10	0.026	30	6	28	68	46
¾	9	<b>729 251 107</b>	10	0.039	36	9	33	83	55
1	9	<b>729 251 108</b>	10	0.068	45	10	41	99	67
1 ¼	9	<b>729 251 109</b>	10	0.109	55	9	50	118	82
1 ½	9	<b>729 251 110</b>	5	0.207	67	13	60	140	97
2	9	<b>729 251 111</b>	10	0.372	87	16	74	175	123
2 ½	6	<b>729 250 112</b>	5	0.605	101	18	91	207	145

### Socket ABS Inch BS

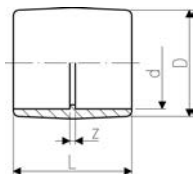

d (inch)	PN (bar)	Code	SP	Weight (kg)	z (mm)	D (mm)	L (mm)
¾	15	<b>729 911 105</b>	10	0.004	3	23	35
½	15	<b>729 911 106</b>	10	0.008	3	27	38
¾	15	<b>729 911 107</b>	10	0.011	3	33	45
1	15	<b>729 911 108</b>	10	0.017	3	41	51
1 ¼	15	<b>729 911 109</b>	10	0.036	3	51	60
1 ½	15	<b>729 911 110</b>	10	0.051	3	58	64
2	15	<b>729 911 111</b>	5	0.095	5	72	78
2 ½	10	<b>729 910 112</b>	10	0.145	4	87	92
3	15	<b>729 911 113</b>	10	0.262	7	104	108
4	15	<b>729 911 115</b>	5	0.470	8	134	135
5	10	<b>729 910 116</b>	2	0.813	7	162	159
6	12	<b>729 911 117</b>	2	1.320	11	197	192
8	12	<b>729 911 120</b>	1	3.700	10	253	248



### Barrel nipple ABS Inch BS

**Model:**

- With solvent cement spigots on both sides
- For quick connections between fittings
- For the shortest possible distance between fittings
- Overall length L = 2 x socket length

d (inch)	PN (bar)	Code	SP	Weight (kg)	L (mm)
3/8	10	<b>729 901 905</b>	0	0.002	28
1/2	10	<b>729 901 906</b>	0	0.004	32
3/4	10	<b>729 901 907</b>	0	0.008	38
1	10	<b>729 901 908</b>	0	0.015	44
1 1/4	10	<b>729 901 909</b>	0	0.027	52
1 1/2	10	<b>729 901 910</b>	0	0.050	62
2	10	<b>729 901 911</b>	0	0.098	76
2 1/2	10	<b>729 900 912</b>	30	0.095	88
3	10	<b>729 901 913</b>	0	0.266	102
4	10	<b>729 901 914</b>	0	0.476	122
5	10	<b>729 900 916</b>	0	0.001	152

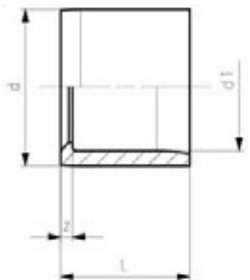

### Reducing bush short pattern ABS Inch BS

d (inch)	d1 (inch)	PN (bar)	Code	SP	Weight (kg)	z (mm)	l (mm)
1/2	3/8	15	<b>729 901 334</b>	10	0.002	2	18
3/4	1/2	15	<b>729 901 337</b>	10	0.003	3	21
1	1/2	15	<b>729 901 342</b>	10	0.015	6	24
1	3/4	15	<b>729 901 341</b>	10	0.008	3	24
1 1/4	1/2	15	<b>729 901 348</b>	0	0.019	11	29
1 1/4	3/4	15	<b>729 901 347</b>	10	0.019	8	29
1 1/4	1	15	<b>729 901 346</b>	10	0.016	5	29
1 1/2	1/2	15	<b>729 901 355</b>	10	0.026	13	30
1 1/2	3/4	15	<b>729 901 354</b>	10	0.027	10	30
1 1/2	1	15	<b>729 901 353</b>	10	0.029	6	30
1 1/2	1 1/4	15	<b>729 901 352</b>	10	0.010	2	30
2	3/4	15	<b>729 901 361</b>	10	0.046	16	37
2	1	15	<b>729 901 360</b>	10	0.048	13	37
2	1 1/4	15	<b>729 901 359</b>	10	0.053	8	37
2	1 1/2	15	<b>729 901 358</b>	10	0.038	6	37
2 1/2	2	15	<b>729 901 364</b>	10	0.710	8	44
3	1	15	<b>729 901 374</b>	10	0.130	27	51
3	1 1/2	15	<b>729 901 372</b>	10	0.135	21	51
3	2	15	<b>729 901 371</b>	10	0.138	14	51
3	2 1/2	15	<b>729 901 370</b>	10	0.095	6	51
4	3	15	<b>729 901 381</b>	20	0.259	13	64
5	4	15	<b>729 901 385</b>	10	0.400	13	76
8	6	12	<b>729 901 396</b>	2	1.310	33	119



### Reducing bush long pattern ABS Inch BS

d-d (inch)	PN (bar)	Code	SP	Weight (kg)	z (mm)	l (mm)
6-4	15	<b>729 911 389</b>	6	1.004	133	197

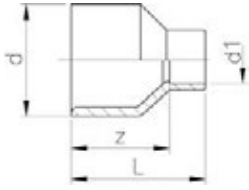

### Cap ABS Inch BS

d (inch)	PN (bar)	Code	SP	Weight (kg)	D (mm)	l (mm)
3/8	15	<b>729 961 105</b>	10	0.004	26	33
1/2	15	<b>729 961 106</b>	10	0.007	30	25
3/4	15	<b>729 961 107</b>	10	0.011	37	30
1	15	<b>729 961 108</b>	10	0.019	44	34
1 1/4	15	<b>729 961 109</b>	10	0.033	55	41
1 1/2	15	<b>729 961 110</b>	10	0.038	62	44
2	15	<b>729 961 111</b>	5	0.100	78	54
2 1/2	15	<b>729 960 112</b>	5	0.115	87	65
3	15	<b>729 961 113</b>	10	0.235	112	77
4	15	<b>729 961 115</b>	5	0.584	145	101
5	15	<b>729 960 116</b>	10	0.880	163	114

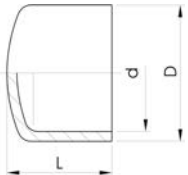

# Adaptor Fittings

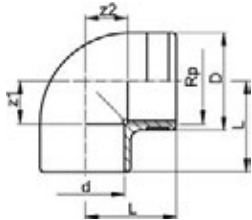

## Elbow 90° ABS Inch BS Rp

### Model:

- With solvent cement socket BS Inch and parallel female thread Rp
- Reinforcing ring stainless (A2)
- Connection to plastic or metal threads
- Do not use thread sealing pastes that are harmful to ABS

d (inch)	Rp (inch)	PN (bar)	Code	SP	Weight (kg)	z1 (mm)	z2 (mm)	D (mm)	L (mm)
½	½	15	<b>729 101 206</b>	10	0.019	12	11	30	27
¾	¾	15	<b>729 101 207</b>	10	0.025	15	15	35	33
1	1	15	<b>729 101 208</b>	10	0.047	18	19	45	39

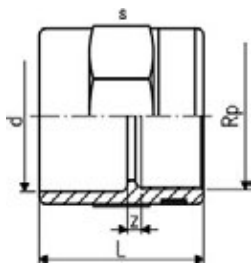

## Socket ABS Inch BS Rp

### Model:

- With solvent cement socket BS Inch and parallel female thread Rp
- Reinforcing ring stainless (A2)
- Connection to plastic or metal threads
- Do not use thread sealing pastes that are harmful to ABS

d (inch)	Rp (inch)	PN (bar)	Code	SP	Weight (kg)	z (mm)	l (mm)	s (mm)
¾	¾	15	<b>729 911 005</b>	10	0.010	4	31	27
½	½	15	<b>729 911 006</b>	10	0.018	4	35	32
¾	¾	15	<b>729 911 007</b>	10	0.024	3	40	36
1	1	15	<b>729 911 008</b>	10	0.038	3	45	36
1 ¼	1 ¼	15	<b>729 911 009</b>	10	0.055	3	51	55
1 ½	1 ½	15	<b>729 911 010</b>	10	0.106	8	69	65
2	2	15	<b>729 911 011</b>	5	0.172	8	69	8

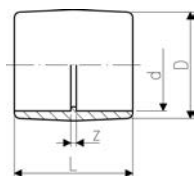

## Adaptor socket ABS metric/Inch BS

### Model:

- With BS Inch and metric solvent cement sockets

d (inch)	d (mm)	PN (bar)	Code	SP	Weight (kg)	z (mm)	D (mm)	L (mm)
½	20	10	<b>729 913 106</b>	1	0.010	5	27	38
¾	25	10	<b>729 913 107</b>	1	0.016	5	33	45
1	32	10	<b>729 913 108</b>	1	0.025	5	41	51
1 ¼	40	10	<b>729 913 109</b>	1	0.045	5	51	60
1 ½	50	10	<b>729 913 110</b>	1	0.070	4	59	65
2	63	10	<b>729 913 111</b>	1	0.130	5	75	79
2 ½	75	10	<b>729 910 112</b>	10	0.145	4	87	92
3	90	10	<b>729 913 113</b>	2	0.365	6	104	108
4	110	10	<b>729 913 115</b>	1	0.630	7	134	135



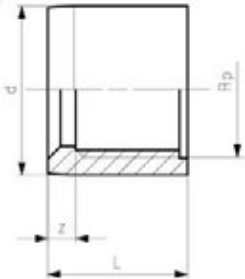

### Reducing bush ABS Inch BS Rp

**Model:**

- With solvent cement spigot BS and parallel female thread Rp
- Connection to plastic threads only
- Do not use thread sealing pastes that are harmful to ABS

d (inch)	Rp (inch)	PN (bar)	Code	SP	Weight (kg)	z (mm)	L (mm)
½	¾	15	<b>729 901 534</b>	10	0.003	3	18
¾	1	15	<b>729 901 537</b>	10	0.011	5	21
1	1 ¼	15	<b>729 901 541</b>	10	0.009	4	24
1	1 ½	15	<b>729 901 542</b>	10	0.015	8	24

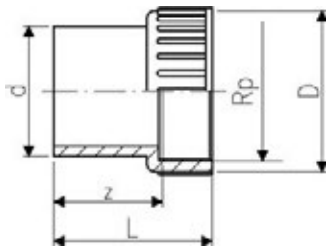

### Adaptor ABS Inch BS Rp

**Model:**

- With solvent cement socket BS Inch and parallel female thread Rp
- Connection to plastic threads only
- Do not use thread sealing pastes that are harmful to ABS

d (inch)	Rp (inch)	PN (bar)	Code	SP	Weight (kg)	z (mm)	l (mm)	s (mm)
½	½	15	<b>729 901 406</b>	10	0.010	21	37	28
¾	¾	15	<b>729 901 407</b>	10	0.025	23	41	34
1	1	15	<b>729 901 408</b>	10	0.037	27	48	42
1 ¼	1 ¼	15	<b>729 901 409</b>	10	0.059	33	56	52
1 ½	1 ½	15	<b>729 901 410</b>	10	0.073	38	61	62
2	2	15	<b>729 901 411</b>	10	0.153	47	74	77

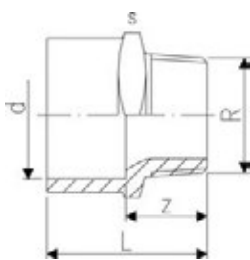

### Adaptor bush ABS Inch BS R

**Model:**

- With solvent cement socket BS Inch and taper male thread R
- Do not use thread sealing pastes that are harmful to ABS

d (inch)	R (inch)	PN (bar)	Code	SP	Weight (kg)	z (mm)	l (mm)	s (mm)
¾	¾	15	<b>729 911 705</b>	10	0.010	20	34	27
½	½	15	<b>729 911 706</b>	10	0.015	24	40	32
¾	¾	15	<b>729 911 707</b>	10	0.017	25	44	36
1	1	15	<b>729 911 708</b>	10	0.031	28	50	46
1 ¼	1 ¼	15	<b>729 911 709</b>	10	0.048	31	57	55
1 ½	1 ½	15	<b>729 911 710</b>	10	0.073	32	63	65
2	2	15	<b>729 911 711</b>	5	0.135	38	76	80

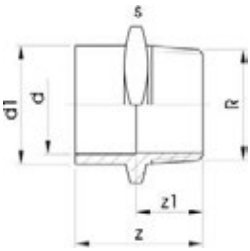

### Adaptor socket nipple ABS Inch BS R

**Model:**

- With solvent cement spigot/reducing socket and taper male thread R
- Do not use thread sealing pastes that are harmful to ABS

d (inch)	d1 (inch)	R (inch)	PN (bar)	Code	SP Weight (kg)	z (mm)	z1 (mm)	s (mm)	
¼	¾	¾	15	<b>729 911 555</b>	0	0.008	36	21	27
¾	½	½	15	<b>729 911 556</b>	10	0.012	43	28	32
½	¾	¾	15	<b>729 911 557</b>	10	0.018	48	31	36
¾	1	1	15	<b>729 911 558</b>	0	0.030	55	35	46

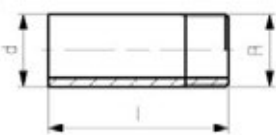

### Adaptor nipple ABS Inch BS R

**Model:**

- With solvent cement spigot BS Inch and taper male thread R
- Do not use thread sealing pastes that are harmful to ABS

d (inch)	R (inch)	PN (bar)	Code	SP Weight (kg)	l (mm)	
¾	¾	15	<b>729 913 905</b>	1	0.007	43
½	½	15	<b>729 913 906</b>	1	0.010	50
¾	¾	15	<b>729 913 907</b>	1	0.016	56
1	1	15	<b>729 913 908</b>	1	0.025	63
1 ¼	1 ¼	15	<b>729 913 909</b>	1	0.045	75
1 ½	1 ½	15	<b>729 913 910</b>	1	0.070	88
2	2	15	<b>729 913 911</b>	1	0.130	88
3	3	15	<b>729 913 913</b>	1	0.365	128
4	4	15	<b>729 913 915</b>	1	0.630	153

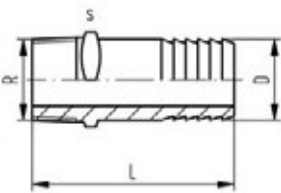

### Hose connector ABS R

**Model:**

- With taper male thread R
- With parallel hose connector
- Do not use thread sealing pastes that are harmful to ABS

d (inch)	PN (bar)	Code	SP Weight (kg)	D (mm)	L (mm)	s (mm)	
½	10	<b>729 961 706</b>	10	0.007	14	70	22
¾	10	<b>729 961 707</b>	10	0.017	20	80	27
1	10	<b>729 961 708</b>	5	0.033	27	90	36

# Threaded Fittings

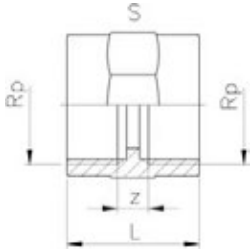

## Threaded socket ABS Rp

### Model:

- With parallel female thread Rp
- Connection to plastic threads only
- Install with low mechanical stress and avoid large cyclic temperature changes
- Do not use thread sealing pastes that are harmful to ABS

Rp (inch)	PN (bar)	Code	SP	Weight (kg)	z (mm)	L (mm)	s (mm)
½	10	<b>729 910 606</b>	10	0.019	9	35	32
¾	10	<b>729 910 607</b>	10	0.022	9	39	36
1	10	<b>729 910 608</b>	10	0.041	11	45	46



A



B

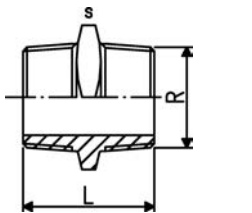

## Threaded nipple R ABS

### Model:

- BSP taper male threads (R)
- Install with low mechanical stress and avoid large cyclic temperature changes
- Do not use thread sealing pastes that are harmful to ABS

R (inch)	PN (bar)	Type	S (mm)	Code	SP	Weight (kg)	L (mm)
¾	10	B		<b>729 911 505</b>	1	0.014	43
½	10	A	22	<b>729 911 906</b>	10	0.009	45
¾	10	A	27	<b>729 911 907</b>	10	0.014	49
1	10	A	36	<b>729 911 908</b>	10	0.026	57
1 ¼	10	B		<b>729 911 509</b>	1	0.053	75
1 ½	10	B		<b>729 911 510</b>	0	0.063	88
2	10	B		<b>729 911 511</b>	0	0.099	88

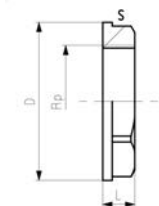

## Backnut ABS Inch BS

### Model:

- Parallel female thread Rp

Rp (inch)	PN (bar)	Code	SP	Weight (kg)	D (mm)	s (mm)
½	15	<b>169 280 002</b>	1	0.010	37	31
¾	15	<b>169 280 003</b>	1	0.021	42	36
1	15	<b>169 280 004</b>	0	0.024	55	46
1 ¼	15	<b>169 280 005</b>	0	0.025	59	50
1 ½	15	<b>169 280 006</b>	1	0.034	70	60
2	15	<b>169 280 007</b>	1	0.065	94	79



## Plug ABS R

### Model:

- With taper male thread R
- Do not use thread sealing pastes that are harmful to ABS

R (inch)	PN (bar)	Code	SP	Weight (kg)	L (mm)	s (mm)
½	10	<b>729 961 906</b>	10	0.008	25	27
¾	10	<b>729 961 907</b>	10	0.014	29	36
1	10	<b>729 961 908</b>	10	0.022	32	41

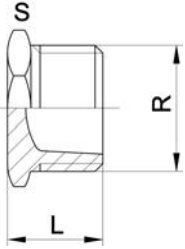

# Flange Adaptors



## Flange adaptor ABS Combined jointing face flat and serrated Inch BS

### Model:

- Gasket: flange gasket EPDM code no. 748 400 306-320, FPM code no. 749 400 306-320

d (inch)	PN (bar)	Code	SP	Weight (kg)	z (mm)	D (mm)	D1 (mm)	L (mm)	L1 (mm)
½	15	<b>729 791 106</b>	10	0.007	3	27	34	21	6
¾	15	<b>729 791 107</b>	0	0.011	3	33	41	24	7
1	15	<b>729 791 108</b>	10	0.018	3	41	50	27	7
1 ¼	15	<b>729 791 109</b>	10	0.027	3	50	61	32	8
1 ½	15	<b>729 791 110</b>	10	0.043	3	61	73	33	8
2	15	<b>729 791 111</b>	5	0.083	3	76	90	41	9
2 ½	10	<b>729 790 112</b>	10	0.116	3	91	106	47	10
3	15	<b>729 791 113</b>	20	0.187	5	108	125	56	11
4	15	<b>729 791 115</b>	20	0.309	5	136	155	69	12
5	10	<b>729 790 116</b>	6	0.535	5	165	188	81	14
6	12	<b>729 791 117</b>	10	0.912	5	198	217	96	16
8	9	<b>729 791 120</b>	2	1.470	6	248	274	122	20

## Full face flange ABS Inch BS Drilled to universal standard

### Model:

- In accordance with BS 10, DIN EN 1092 and ASME B 16.5
- Jointing face serrated
- It is recommended to use backing flanges in conjunction with all Full Face Flanges
- All Full Face Flanges are manufactured with outside diameter to BS EN 1092
- Solvent cement socket BS inch
- For pressure ratings over 2 bar backing flanges must be used

AL: number of holes



d (inch)	DN (mm)	PN (bar)	Code	Weight (kg)	D3 (mm)	D2 (mm)	D1 (mm)	AL	H1 (mm)	z (mm)	D (mm)	H (mm)
½	15	10	<b>729 733 106</b>	0.064	15	27	67	4	21	3	95	10
¾	20	10	<b>729 733 107</b>	0.083	15	33	73	4	24	8	105	10
1	25	10	<b>729 733 108</b>	0.097	15	41	83	4	27	3	115	10
1 ¼	32	10	<b>729 733 109</b>	0.149	15	50	88	4	32	3	140	10
1 ½	40	10	<b>729 733 110</b>	0.180	15	61	98	4	33	3	150	10
2	50	10	<b>729 733 111</b>	0.230	18	77	115	4	40	3	165	10
3	80	10	<b>729 733 113</b>	0.238	18	108	146	4	56	5	200	12
4	100	10	<b>729 733 114</b>	0.771	18	136	178	8	69	5	220	17
6	150	10	<b>729 733 117</b>	1.486	22	198	235	8	96	5	285	22

# Unions

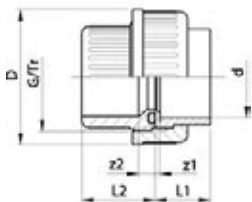

## Union ABS Inch BS

### Model:

- Union Bush: Solvent cement socket BS inch
- Union End: Solvent cement socket BS Inch
- Gasket: O-ring EPDM code no. 748 410 004-014

d (inch)	PN (bar)	Code	SP	Weight (kg)	z1 (mm)	z2 (mm)	D (mm)	L1 (mm)	L2 (mm)
3/8	15	729 511 105	10	0.019	3	8	35	19	24
1/2	15	729 511 106	10	0.035	3	9	43	21	26
3/4	15	729 511 107	10	0.049	3	9	53	24	29
1	15	729 511 108	10	0.070	3	9	60	27	33
1 1/4	15	729 511 109	10	0.127	3	10	74	32	39
1 1/2	15	729 511 110	5	0.220	3	10	83	33	41
2	15	729 511 111	10	0.402	3	10	103	40	48
2 1/2	10	729 510 112	2	0.469	3	18	135	47	62

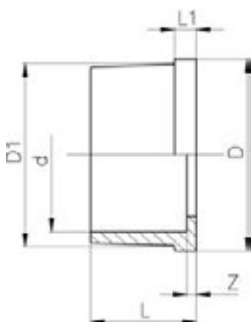

## Union end ABS Inch BS

### Model:

- Solvent cement socket BS inch

d (inch)	PN (bar)	Code	SP	Weight (kg)	z (mm)	D (mm)	D1 (mm)	L (mm)
3/8	15	729 601 105	10	0.004	3	24	22	19
1/2	15	729 601 106	2000	0.006	3	30	27	21
3/4	15	729 601 107	1800	0.010	3	38	36	24
1	15	729 601 108	1000	0.015	3	44	41	27
1 1/4	15	729 601 109	300	0.027	3	56	53	32
1 1/2	15	729 601 110	0	0.003	3	62	59	33
2	15	729 601 111	0	0.062	3	78	74	40

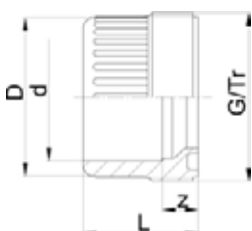

## Union bush ABS Inch BS

### Model:

- Solvent cement socket BS inch

d (inch)	PN (bar)	Code	SP	Weight (kg)	z (mm)	D (mm)	L (mm)	G/Tr (inch)
3/8	15	729 641 105	0	0.005	8	24	24	3/4
1/2	15	729 641 106	0	0.009	9	28	26	1
3/4	15	729 641 107	1000	0.015	9	34	29	1 1/4
1	15	729 641 108	800	0.022	9	42	33	1 1/2
1 1/4	15	729 641 109	470	0.040	10	52	39	2
1 1/2	15	729 641 110	250	0.058	10	62	46	2 1/4
2	15	729 641 111	180	0.097	10	78	58	2 3/4



### Union nut

Size (inch)	DN (mm)	ABS Code	Weight (kg)
½	15	<b>729 890 406</b>	0.048
¾	20	<b>729 890 407</b>	0.046
1	25	<b>729 890 408</b>	0.025
1 ¼	32	<b>729 890 409</b>	0.060
1 ½	40	<b>729 890 410</b>	0.100
2	50	<b>729 890 411</b>	0.147

---

# Adaptor Unions



## Adaptor union ABS/PVC-U Inch BS

### Model:

- Union Nut: ABS
- Union Bush: Solvent cement socket ABS BS inch
- Union End: Solvent cement socket PVC-U BS Inch
- Gasket: O-ring EPDM code no. 748 410 005-011

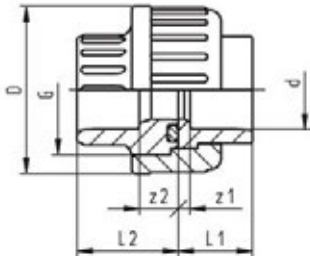

d (inch)	PN (bar)	Code	SP	Weight (kg)	z1 (mm)	z2 (mm)	D (mm)	L1 (mm)	L2 (mm)
3/8	15	<b>729 521 105</b>	10	0.025	3	8	35	19	24
1/2	15	<b>729 521 106</b>	10	0.041	3	9	43	21	26
3/4	15	<b>729 521 107</b>	10	0.066	3	9	53	24	29
1	15	<b>729 521 108</b>	10	0.093	3	9	60	27	32
1 1/4	15	<b>729 521 109</b>	10	0.155	3	10	74	32	38
1 1/2	15	<b>729 521 110</b>	2	0.209	3	10	83	33	40
2	15	<b>729 521 111</b>	2	0.368	3	10	103	40	46



## Adaptor union ABS BS Inch/PVC-U metric

### Model:

- Union Nut: ABS
- Union Bush: Solvent cement socket ABS BS inch
- Union End: Solvent cement socket PVC-U metric
- Gasket: O-ring EPDM code no. 748 410 005-011

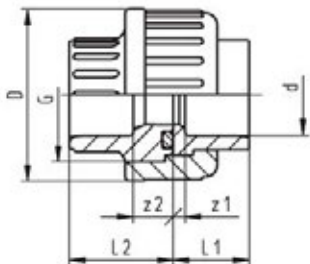

d (inch)	d (mm)	PN (bar)	Code	SP	Weight (kg)	z1 (mm)	z2 (mm)	D (mm)	L1 (mm)	L2 (mm)
3/8	16	15	<b>729 523 105</b>	10	0.075	3	13	35	19	24
1/2	20	15	<b>729 523 106</b>	0	0.120	3	13	43	21	26
3/4	25	15	<b>729 523 107</b>	10	0.190	3	14	53	24	29
1	32	15	<b>729 523 108</b>	10	0.250	3	15	60	27	32
1 1/4	40	15	<b>729 523 109</b>	10	0.400	3	19	74	32	38
1 1/2	50	15	<b>729 523 110</b>	0	0.510	3	26	83	33	40
2	63	15	<b>729 523 111</b>	10	0.287	3	33	103	40	46



## Adaptor union ABS/PVC-U Inch BS Rp

### Model:

- Union nut: PVC-U
- Union Bush: PVC-U parallel female thread Rp
- Union End: Solvent cement socket ABS BS inch
- Gasket: O-ring EPDM code no. 748 410 005-011
- Connection to plastic threads only
- Do not use thread sealing pastes that are harmful to PVC-U

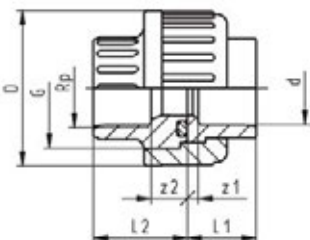

d (inch)	Rp (inch)	PN (bar)	Code	SP	Weight (kg)	z1 (mm)	z2 (mm)	D (mm)	L1 (mm)	L2 (mm)
3/8	3/8	15	<b>729 511 205</b>	10	0.025	3	13	35	19	24
1/2	1/2	15	<b>729 511 206</b>	10	0.041	3	13	43	21	26
3/4	3/4	15	<b>729 511 207</b>	10	0.100	3	14	53	24	29
1	1	15	<b>729 511 208</b>	10	0.172	3	15	60	27	32
1 1/4	1 1/4	15	<b>729 511 209</b>	10	0.200	3	19	74	32	38
1 1/2	1 1/2	15	<b>729 511 210</b>	2	0.277	3	26	83	33	40
2	2	15	<b>729 511 211</b>	2	0.430	3	33	103	40	46





### Adaptor union ABS/malleable iron galvanised Inch BS Rp

**Model:**

- Union Nut: ABS
- Union Bush: Solvent cement socket BS Inch
- Union End: malleable iron with parallel female thread Rp
- Gasket: O-ring EPDM code no. 748 410 006-011

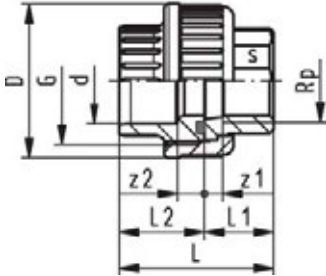

d (inch)	Rp (inch)	PN	Code	SP	Weight (kg)	z1 (mm)	z2 (mm)	D (mm)	L (mm)	L1 (mm)	L2 (mm)	G (inch)	s (mm)
1/2	1/2	15	<b>729 531 306</b>	10	0.132	9	10	43	48	22	26	1	25
3/4	3/4	15	<b>729 531 307</b>	5	0.226	7	10	51	51	22	29	1 1/4	31
1	1	15	<b>729 531 308</b>	5	0.282	9	10	58	58	26	33	1 1/2	38
1	1 1/4	15	<b>729 531 309</b>	2	0.476	12	12	72	69	31	39	2	48
1 1/2	1 1/2	15	<b>729 531 310</b>	2	0.498	14	14	83	78	33	46	2 1/4	54
2	2	15	<b>729 531 311</b>	5	0.795	11	18	100	91	35	58	2 3/4	67



### Adaptor union ABS/malleable iron galvanised Inch BS R

**Model:**

- Union Nut: ABS
- Union Bush: Solvent cement socket BS Inch
- Union End: Malleable iron with taper male thread R
- Gasket: O-ring EPDM code no. 748 410 006-011

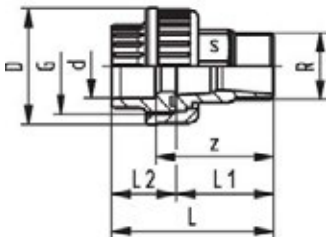

d (inch)	R (inch)	PN* (bar)	Code	SP	Weight (kg)	z (mm)	D (mm)	L (mm)	L2 (mm)	L1 (mm)	G (inch)	s (mm)
1/2	1/2	15	<b>729 531 806</b>	10	0.137	50	43	66	26	40	1	25
3/4	3/4	15	<b>729 531 807</b>	5	0.226	53	51	72	29	43	1 1/4	31
1	1	15	<b>729 531 808</b>	5	0.322	58	58	80	33	48	1 1/2	38
1 1/4	1 1/4	15	<b>729 531 809</b>	2	0.554	69	72	95	39	57	2	48
1 1/2	1 1/2	15	<b>729 531 810</b>	2	0.654	73	83	104	46	59	2 1/4	54
2	2	15	<b>729 531 811</b>	8	0.935	80	100	118	58	62	2 3/4	67



### Adaptor union Rp ABS/Brass Inch BS

**Model:**

- Union Nut: ABS
- Union Bush: Solvent cement socket ABS BS inch
- Union End: Brass with parallel female thread Rp
- Gasket: O-ring EPDM code no. 748 410 006-011

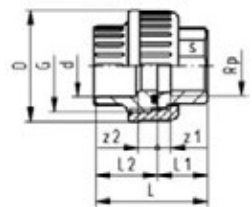

d (inch)	Rp (inch)	PN (bar)	Code	SP	Weight (kg)	z1 (mm)	z2 (mm)	D (mm)	L (mm)	L1 (mm)	L2 (mm)	G (inch)	s (mm)
1/2	1/2	15	<b>729 551 506</b>	10	0.084	7	9	43	48	22	26	1	25
3/4	3/4	15	<b>729 551 507</b>	5	0.134	9	8	51	54	25	29	1 1/4	30
1	1	15	<b>729 551 508</b>	5	0.157	8	9	58	60	27	33	1 1/2	36
1 1/4	1 1/4	15	<b>729 551 509</b>	2	0.327	10	11	72	70	31	39	2	46
1 1/2	1 1/2	15	<b>729 551 510</b>	2	0.452	13	11	83	75	35	41	2 1/4	55
2	2	15	<b>729 551 511</b>	5	0.722	14	12	100	88	40	48	2 3/4	65



### Adaptor union R ABS/brass Inch BS

#### Model:

- Union Nut: ABS
- Union Bush: Solvent cement socket ABS BS inch
- Union End: Brass with taper male thread R
- Gasket: O-ring EPDM code no. 748 410 006-011

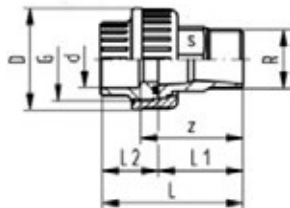

d (inch)	R (inch)	PN (bar)	Code	SP	Weight (kg)	z (mm)	D (mm)	L (mm)	L1 (mm)	L2 (mm)	G (inch)	s (mm)
1/2	1/2	15	<b>729 551 906</b>	10	0.123	37	43	63	37	26	1	25
3/4	3/4	15	<b>729 551 907</b>	5	0.185	42	51	71	42	29	1 1/4	30
1	1	15	<b>729 551 908</b>	5	0.283	55	58	79	46	33	1 1/2	36
1 1/4	1 1/4	15	<b>729 551 909</b>	2	0.503	60	72	91	52	39	2	46
1 1/2	1 1/2	15	<b>729 551 910</b>	2	0.666	65	83	97	56	41	2 1/4	55
2	2	15	<b>729 551 911</b>	8	1.029	77	100	115	67	48	2 3/4	65



### Tank connector ABS Inch BS

#### Model:

- End connection: Union with solvent cement socket BS Inch
- Gasket: flat gasket EPDM

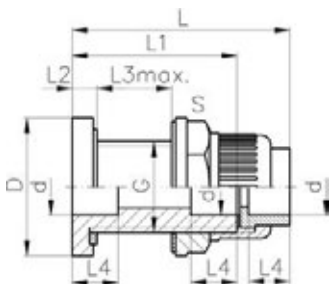







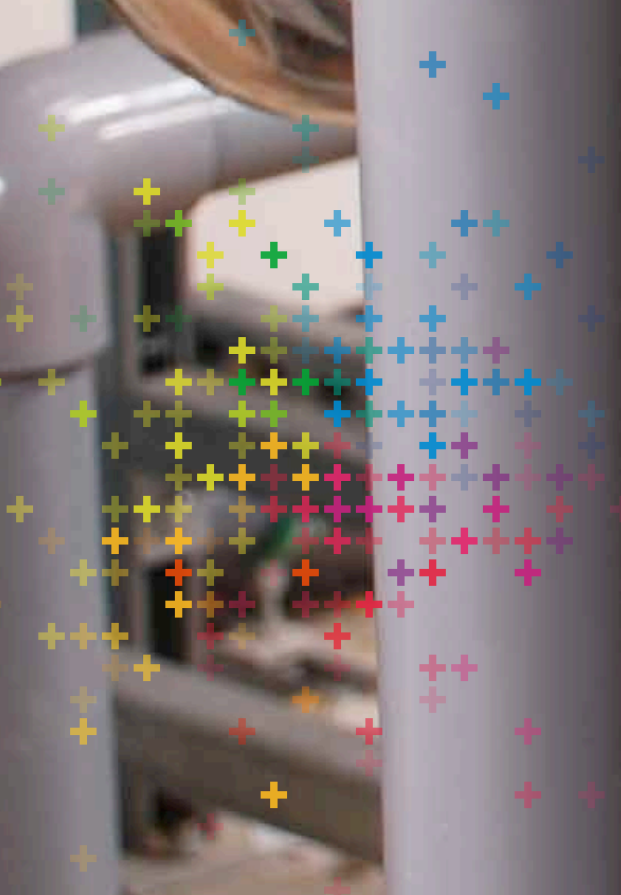

d (inch)	PN (bar)	Code	Weight (kg)	d1 (mm)	L (mm)	L1 (mm)	L2 (mm)	L3 (mm)	L4 (mm)	G (inch)	s (mm)
3/8	15	<b>169 250 225</b>	0.073	44	85	65	10	32	14	3/4	33
1/2	15	<b>169 250 226</b>	0.131	56	89	67	11	30	16	1	46
3/4	15	<b>169 250 227</b>	0.194	65	97	72	12	32	19	1 1/4	50
1	15	<b>169 250 228</b>	0.001	70	103	75	12	33	22	1 1/2	60
1 1/4	15	<b>169 250 229</b>	0.446	95	111	78	12	32	26	2	80
1 1/2	15	<b>169 250 230</b>	0.455	95	119	82	13	32	31	2 1/4	80
2	15	<b>169 250 231</b>	0.001	115	131	87	13	33	38	2 3/4	83



# COOL-FIT ABS

Ideal for cold and chilled water



	Pipes	24
	Solvent Cement Fittings	25
	Adaptor Fittings	32
	Flange Adaptors	35
	Unions	36
	Adaptor Unions	38
	Branch Saddles	41

# Pipes

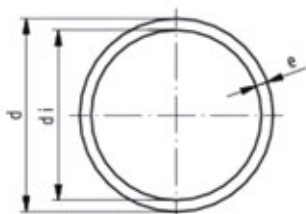

## Pipe ABS Nominal pressure PN10 (at 20°C)

### Model:

- Colour: RAL 7001, gravel grey
- Pipe length: 5m, with plain ends
- Minimum order quantity: 1 length

d (mm)	PN (bar)	Code	Weight (kg/m)	e (mm)	di (mm)
20	10	20014B601	0.100	1.65	16.7
25	10	20014B602	0.148	1.95	21.1
32	10	20014B603	0.211	2.10	27.7
40	10	20014B604	0.331	2.70	34.6
50	10	20014B605	0.506	3.30	43.4
63	10	20014B606	0.809	4.20	54.5
75	10	20014B607	1.125	4.90	65.2
90	10	20014B608	1.612	6.00	78.0
110	10	20014B609	2.392	7.20	95.6
140	10	20014B610	3.880	9.20	121.6
160	10	20014B611	5.046	10.40	139.1
200	10	20014B612	7.984	13.00	173.9
225	10	20014B613	10.149	14.70	195.6

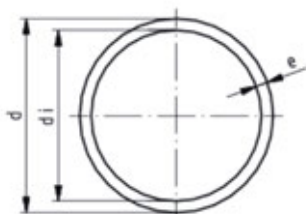

## Pipe ABS Nominal pressure PN6 (at 20°C)

### Model:

- Colour: RAL 7001, gravel grey
- Pipe length: 5m, with plain ends
- Minimum order quantity: 1 length

d (mm)	PN (bar)	Code	Weight (kg/m)	e (mm)	di (mm)
250	6	20014B614	8.299	9.6	230.8
280	6	20014B615	10.346	10.7	258.6
315	6	20014B616	13.173	12.1	290.8



# Solvent Cement Fittings

## Bend 90° ABS metric

- Radius = 2 d



$r = 2d$

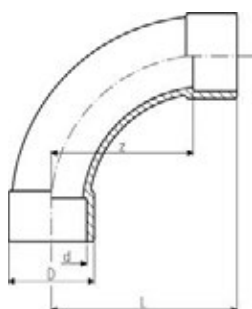

d (mm)	PN (bar)	Code	SP	Weight (kg)	z (mm)	D (mm)	L (mm)
20	16	<b>729 000 106</b>	10	0.027	40	27	58
25	16	<b>729 000 107</b>	10	0.039	50	35	69
32	10	<b>729 000 108</b>	10	0.056	64	38	86
40	10	<b>729 000 109</b>	30	0.099	80	54	109
50	10	<b>729 000 110</b>	10	0.229	100	61	131
63	10	<b>729 000 111</b>	4	0.391	126	76	164
75	10	<b>729 000 112</b>	5	0.595	150	90	194
90	10	<b>729 000 113</b>	5	1.044	180	113	231
110	10	<b>729 000 114</b>	5	2.101	220	137	281
140	10	<b>729 000 116</b>	1	3.996	280	168	356
* 160	10	<b>729 000 117</b>	1	5.600	320	191	406

## Bend 90° short pattern ABS metric

- >d225 - maximum operating temperature: +40°C

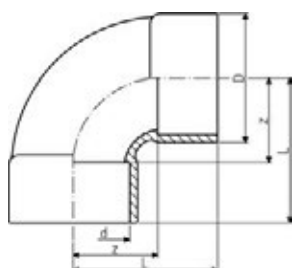

d (mm)	PN (bar)	Code	SP	Weight (kg)	z (mm)	D (mm)	L (mm)
225	10	<b>729 010 120</b>	1	5.741	168	256	287
280	6	<b>729 010 122</b>	1	18.000	210	318	357
315	6	<b>729 010 123</b>	1	21.000	237	356	401

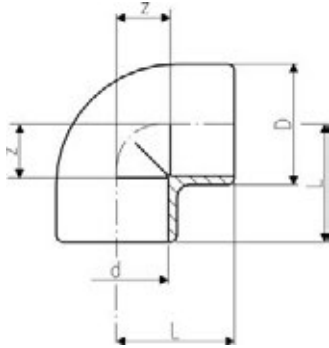

### Elbow 90° ABS metric

- >d225 - maximum operating temperature: +40°C

d (mm)	PN (bar)	Code	SP	Weight (kg)	z (mm)	D (mm)	L (mm)
20	16	729 100 106	10	0.010	11	26	27
25	16	729 100 107	10	0.018	14	31	33
32	10	729 100 108	10	0.033	17	40	39
40	10	729 100 109	10	0.055	21	49	47
50	10	729 100 110	10	0.098	26	61	57
63	10	729 100 111	10	0.186	33	76	72
75	10	729 100 112	5	0.300	40	90	84
90	10	729 100 113	5	0.432	46	110	97
110	10	729 100 114	3	0.769	55	136	116
140	10	729 100 116	4	1.516	70	162	146
160	10	729 100 117	1	2.177	80	185	166
200	10	729 100 119	1	3.372	101	225	207
250	6	729 100 121	1	8.218	131	282	263

### Elbow 45° ABS metric

- >d225 - maximum operating temperature: +40°C

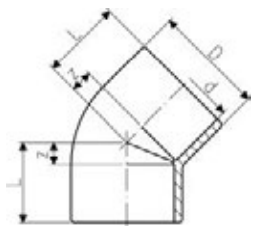

d (mm)	PN (bar)	Code	SP	Weight (kg)	z (mm)	D (mm)	L (mm)
20	16	729 150 106	10	0.009	5	25	21
25	16	729 150 107	10	0.013	6	31	25
32	10	729 150 108	10	0.026	8	40	30
40	10	729 150 109	10	0.044	10	49	36
50	10	729 150 110	5	0.079	12	61	43
63	10	729 150 111	10	0.143	14	76	52
75	10	729 150 112	5	0.225	17	89	61
90	10	729 150 113	4	0.363	20	107	71
110	10	729 150 114	10	0.567	28	131	89
140	10	729 150 116	1	1.175	32	162	108
160	10	729 150 117	4	1.713	36	185	122
200	10	729 150 119	1	2.546	43	225	149
225	10	729 150 120	1	3.162	49	250	168
250	6	729 150 121	1	6.139	60	282	192
280	6	729 150 122	1	10.500	66	318	213
315	6	729 150 123	1	14.600	74	356	239

### Tee 90° ABS metric

- >d225 - maximum operating temperature: +40°C

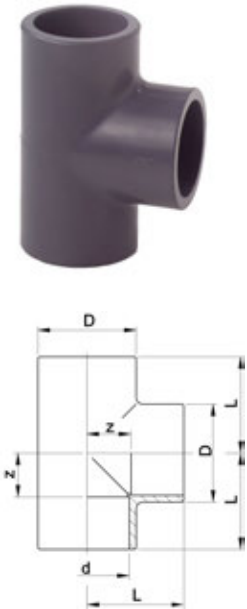

d (mm)	PN (bar)	Code	Weight (kg)	z (mm)	D (mm)	L (mm)
20	16	<b>729 200 106</b>	0.015	11	25	27
25	16	<b>729 200 107</b>	0.025	14	31	33
32	10	<b>729 200 108</b>	0.042	17	40	39
40	10	<b>729 200 109</b>	0.078	21	49	47
50	10	<b>729 200 110</b>	0.134	26	61	57
63	10	<b>729 200 111</b>	0.255	34	76	72
75	10	<b>729 200 112</b>	0.404	40	90	84
90	10	<b>729 200 113</b>	0.664	47	107	98
110	10	<b>729 200 114</b>	1.010	55	133	116
140	10	<b>729 200 116</b>	2.570	71	169	147
160	10	<b>729 200 117</b>	3.752	81	193	167
200	10	<b>729 200 119</b>	4.446	101	225	207
225	10	<b>729 200 120</b>	6.860	114	256	233
250	6	<b>729 200 121</b>	11.189	132	282	263
280	6	<b>729 200 122</b>	11.989	152	318	298
315	6	<b>729 200 123</b>	20.000	168	356	332

### Tee 90° reducing ABS metric

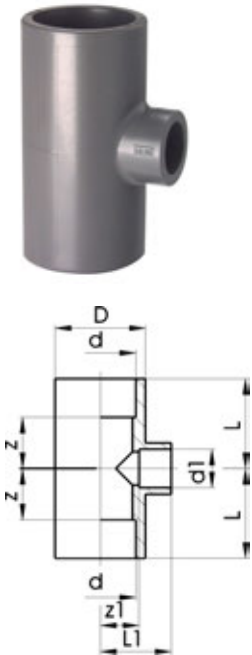

d (mm)	d1 (mm)	PN (bar)	Code	Weight (kg)	z (mm)	z1 (mm)	D (mm)	L (mm)	L1 (mm)
25	20	16	<b>729 200 134</b>	0.030	14	14	33	33	30
32	25	10	<b>729 200 138</b>	0.049	17	17	41	39	36
40	25	10	<b>729 200 151</b>	0.083	23	23	50	49	42
40	32	10	<b>729 200 147</b>	0.085	23	23	50	49	45
50	25	10	<b>729 200 010</b>	0.138	28	28	62	59	47
50	32	10	<b>729 200 164</b>	0.141	28	28	62	59	50
63	25	10	<b>729 200 011</b>	0.246	34	34	77	73	53
63	32	10	<b>729 200 178</b>	0.256	35	34	77	73	56
63	50	10	<b>729 200 170</b>	0.270	35	34	77	73	65
75	40	10	<b>729 200 182</b>	0.397	40	41	92	84	66
90	32	10	<b>729 200 143</b>	0.671	46	55	110	97	77
90	63	10	<b>729 200 146</b>	0.715	46	55	110	97	93
110	32	10	<b>729 200 144</b>	1.109	56	67	133	117	89
110	50	10	<b>729 200 136</b>	1.143	56	67	133	117	98
140	50	10	<b>729 200 148</b>	2.452	72	82	172	148	113
140	75	10	<b>729 200 149</b>	2.478	72	78	172	148	122
160	110	10	<b>729 200 152</b>	4.305	81	91	192	167	142
160	90	10	<b>729 200 158</b>	3.431	81	91	192	167	142
200	110	10	<b>729 200 153</b>	6.688	106	131	232	213	192
225	110	10	<b>729 200 156</b>	8.096	119	143	257	239	204
225	160	10	<b>729 200 157</b>	7.485	119	119	257	239	205

### Tee 45° ABS metric

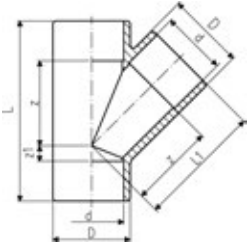

d (mm)	PN (bar)	Code	Weight (kg)	z (mm)	z1 (mm)	D (mm)	L (mm)	L1 (mm)
20	10	<b>729 250 106</b>	0.027	30	6	28	68	46
25	10	<b>729 250 107</b>	0.043	36	9	33	83	55
32	10	<b>729 250 108</b>	0.073	45	10	41	99	67
40	10	<b>729 250 109</b>	0.123	56	10	50	118	82
50	10	<b>729 250 110</b>	0.202	66	12	60	140	97
63	10	<b>729 250 111</b>	0.334	85	14	74	175	123
75	6	<b>729 250 112</b>	0.605	101	18	91	207	145
90	6	<b>729 250 113</b>	0.961	122	20	107	245	173
110	6	<b>729 250 114</b>	1.907	149	27	134	298	210

### Cross ABS metric

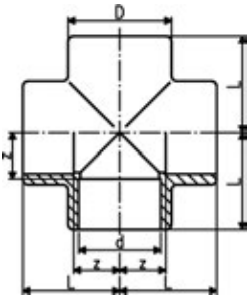

d (mm)	PN (bar)	Code	Weight (kg)	z (mm)	D (mm)	L (mm)
32	10	<b>729 300 108</b>	0.070	17	43	39
63	10	<b>729 300 111</b>	0.359	34	79	72
90	10	<b>729 300 113</b>	0.937	48	106	97

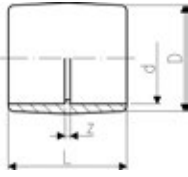

### Socket ABS metric

- >d225 - maximum operating temperature: +40°C

d (mm)	PN (bar)	Code	Weight (kg)	z (mm)	D (mm)	L (mm)
20	16	<b>729 910 106</b>	0.007	3	26	35
25	16	<b>729 910 107</b>	0.012	3	32	41
32	10	<b>729 910 108</b>	0.020	3	40	47
40	10	<b>729 910 109</b>	0.035	3	49	55
50	10	<b>729 910 110</b>	0.060	3	61	65
63	10	<b>729 910 111</b>	0.110	3	76	79
75	10	<b>729 910 112</b>	0.145	4	87	92
90	10	<b>729 910 113</b>	0.241	5	104	107
110	10	<b>729 910 114</b>	0.566	5	131	132
140	10	<b>729 910 116</b>	0.813	7	162	159
160	10	<b>729 910 117</b>	1.176	8	183	180
200	10	<b>729 910 119</b>	1.511	9	221	221
225	10	<b>729 910 120</b>	2.537	10	253	248
250	6	<b>729 910 121</b>	4.058	16	284	284
280	6	<b>729 910 122</b>	6.043	16	321	314
315	6	<b>729 910 123</b>	8.100	16	356	348

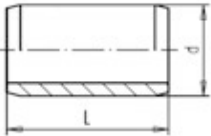

### Barrel nipple ABS metric

#### Model:

- With solvent cement spigots on both sides
- For the shortest possible distance between fittings
- Overall length L = 2 x socket length

d (mm)	PN (bar)	Code	Weight (kg)	L (mm)
20	16	<b>729 900 906</b>	0.008	32
25	16	<b>729 900 907</b>	0.008	38
32	10	<b>729 900 908</b>	0.007	44
40	10	<b>729 900 909</b>	0.016	52
50	10	<b>729 900 910</b>	0.032	62
63	10	<b>729 900 911</b>	0.059	76
75	10	<b>729 900 912</b>	0.095	88
90	10	<b>729 900 913</b>	0.161	102
110	10	<b>729 900 914</b>	0.282	122

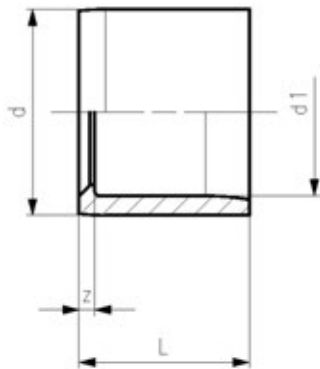

## Reducing bush ABS metric

### Model:

- With solvent cement spigot and socket metric

	d (mm)	d1 (mm)	PN (bar)	Code	Weight (kg)	z (mm)	L (mm)
*	25	20	16	<b>729 900 337</b>	0.005	3	19
*	32	20	10	<b>729 900 342</b>	0.011	6	22
*	32	25	10	<b>729 900 341</b>	0.008	4	22
	40	20	10	<b>729 900 348</b>	0.016	10	26
	40	25	10	<b>729 900 347</b>	0.016	7	26
*	40	32	10	<b>729 900 346</b>	0.012	4	26
	50	20	10	<b>729 900 355</b>	0.026	15	31
	50	25	10	<b>729 900 354</b>	0.011	12	31
	50	32	10	<b>729 900 353</b>	0.035	9	31
*	50	40	10	<b>729 900 352</b>	0.022	5	31
	63	32	10	<b>729 900 360</b>	0.060	16	38
	63	40	10	<b>729 900 359</b>	0.051	12	38
*	63	50	10	<b>729 900 358</b>	0.043	7	36
	75	50	10	<b>729 900 365</b>	0.082	13	44
*	75	63	10	<b>729 900 364</b>	0.061	7	44
	90	50	10	<b>729 900 372</b>	0.143	20	51
	90	63	10	<b>729 900 371</b>	0.129	14	51
*	90	75	10	<b>729 900 370</b>	0.100	7	51
	110	63	10	<b>729 900 378</b>	0.231	24	61
*	110	90	10	<b>729 900 376</b>	0.196	10	61
*	125	110	10	<b>700 244 660</b>	0.356	8	69
*	140	110	10	<b>729 900 385</b>	0.459	15	76
	160	110	10	<b>729 900 390</b>	0.662	25	86
*	160	140	10	<b>729 900 388</b>	0.410	10	86
	200	160	10	<b>729 900 392</b>	0.820	20	106
	225	160	10	<b>729 900 396</b>	1.651	33	119
*	225	200	10	<b>729 900 181</b>	1.018	13	119
*	250	225	6	<b>729 900 303</b>	1.294	12	131
*	280	250	6	<b>729 900 306</b>	2.500	15	146
	315	280	6	<b>729 900 312</b>	2.852	17	164

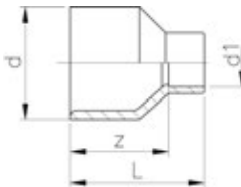

## Reducing bush long ABS metric

### Model:

- With solvent cement spigot and socket metric

	d (mm)	d1 (mm)	PN (bar)	Code	Weight (kg)	z (mm)	L (mm)
	32	20	10	<b>729 910 342</b>	0.014	30	46
	40	25	10	<b>729 910 347</b>	0.026	36	55
	50	25	10	<b>729 910 354</b>	0.038	44	63
	63	32	10	<b>729 910 360</b>	0.077	54	76
	75	40	10	<b>729 910 366</b>	0.115	62	88
	90	63	10	<b>729 910 371</b>	0.215	74	112



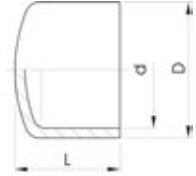

### Cap ABS metric

d (mm)	PN (bar)	Code	Weight (kg)	D (mm)	L (mm)
20	16	<b>729 960 106</b>	0.007	30	25
25	16	<b>729 960 107</b>	0.013	37	30
32	10	<b>729 960 108</b>	0.019	44	34
40	10	<b>729 960 109</b>	0.034	55	41
50	10	<b>729 960 110</b>	0.046	64	44
63	10	<b>729 960 111</b>	0.088	80	54
75	10	<b>729 960 112</b>	0.115	87	65
90	10	<b>729 960 113</b>	0.218	112	77
110	10	<b>729 960 114</b>	0.499	145	101
140	10	<b>729 960 116</b>	0.880	163	114
160	10	<b>729 960 117</b>	1.140	188	130

# Adaptor Fittings

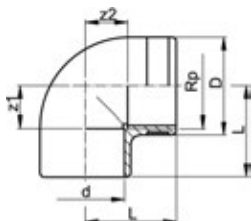

## Elbow 90° ABS metric Rp

### Model:

- With solvent cement socket metric and parallel female thread Rp
- Reinforcing ring stainless (A2)
- Connection to plastic or metal threads
- Install with low mechanical stress and avoid large cyclic temperature changes
- Do not use thread sealing pastes that are harmful to ABS

d (mm)	Rp (inch)	PN (bar)	Code	Weight (kg)	z1 (mm)	z2 (mm)	D (mm)	L (mm)
20	½	10	729 100 206	0.018	11	14	30	27
25	¾	10	729 100 207	0.028	14	17	35	33
32	1	10	729 100 208	0.047	17	22	45	39
40	1 ¼	10	729 100 209	0.088	23	27	55	50
50	1 ½	10	729 100 210	0.128	27	36	62	58
63	2	10	729 100 211	0.233	33	46	75	73

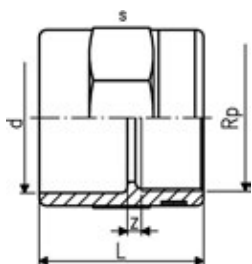

## Socket ABS metric Rp

### Model:

- With solvent cement socket metric and parallel female thread Rp
- Reinforcing ring stainless (A2)
- Connection to plastic or metal threads
- Install with low mechanical stress and avoid large cyclic temperature changes
- Do not use thread sealing pastes that are harmful to ABS

d (mm)	Rp (inch)	PN (bar)	Code	Weight (kg)	closest inch (inch)	z (mm)	L (mm)	s (mm)
20	½	10	729 910 206	0.020	½	4	35	32
25	¾	10	729 910 207	0.025	¾	3	40	36
32	1	10	729 910 208	0.045	1	3	45	46
40	1 ¼	10	729 910 209	0.067	1 ¼	5	51	55
50	1 ½	10	729 910 210	0.099	1 ½	7	59	65
63	2	10	729 910 211	0.167	2	7	69	80

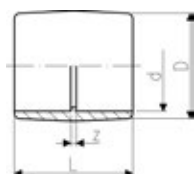

## Adaptor socket ABS metric/Inch BS

### Model:

- With BS Inch and metric solvent cement sockets

d (mm)	d (inch)	PN (bar)	Code	Weight (kg)	z (mm)	D (mm)	L (mm)
20	½	10	729 913 106	0.010	5	27	38
25	¾	10	729 913 107	0.016	5	33	45
32	1	10	729 913 108	0.025	5	41	51
40	1 ¼	10	729 913 109	0.045	5	51	60
50	1 ½	10	729 913 110	0.070	4	59	65
63	2	10	729 913 111	0.130	5	75	79
75	2 ½	10	729 910 112	0.145	4	87	92
90	3	10	729 913 113	0.365	6	104	108
110	4	10	729 913 115	0.630	7	134	135

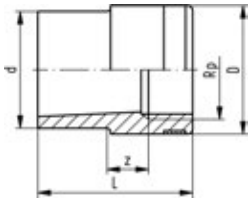

### Reducing bush ABS metric Rp

**Model:**

- With solvent cement spigot metric and parallel female thread Rp
- Reinforcing ring stainless (A2)
- Connection to plastic or metal threads
- Install with low mechanical stress and avoid large cyclic temperature changes
- Do not use thread sealing pastes that are harmful to ABS

d (mm)	Rp (inch)	PN (bar)	Code	Weight (kg)	z (mm)	D (mm)	L (mm)
20	¾	10	<b>729 910 434</b>	0.012	7	25	35
25	½	10	<b>729 910 437</b>	0.017	7	30	41
32	¾	10	<b>729 910 441</b>	0.025	15	35	48
40	1	10	<b>729 910 446</b>	0.046	20	45	56
50	1 ¼	10	<b>729 910 452</b>	0.077	20	55	66
63	1 ½	10	<b>729 910 458</b>	0.120	10	62	77

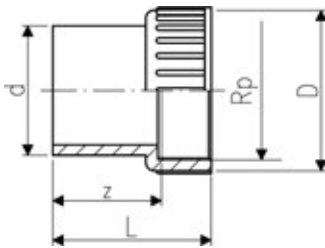

### Adaptor ABS metric Rp

**Model:**

- With solvent cement spigot metric and parallel female thread Rp
- Connection to plastic threads only
- Install with low mechanical stress and avoid large cyclic temperature changes
- Do not use thread sealing pastes that are harmful to ABS

d (mm)	Rp (inch)	PN (bar)	Code	Weight (kg)	z (mm)	D (mm)	L (mm)
20	½	10	<b>729 900 406</b>	0.008	21	28	37
25	¾	10	<b>729 900 407</b>	0.014	23	33	41
32	1	10	<b>729 900 408</b>	0.026	27	42	48
40	1 ¼	10	<b>729 900 409</b>	0.044	33	52	56
50	1 ½	10	<b>729 900 410</b>	0.076	38	62	61
63	2	10	<b>729 900 411</b>	0.127	47	77	74

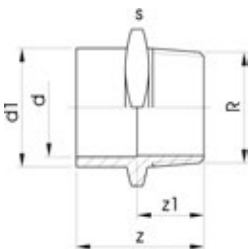

### Adaptor socket nipple ABS metric R

**Model:**

- With solvent cement spigot/socket metric and taper male thread R
- Do not use thread sealing pastes that are harmful to ABS

d (mm)	d1 (mm)	R (inch)	PN (bar)	Code	Weight (kg)	z (mm)	z1 (mm)	s (mm)
16	20	½	10	<b>729 910 556</b>	0.012	42	28	32
20	25	¾	10	<b>729 910 557</b>	0.017	47	31	36
25	32	1	10	<b>729 910 558</b>	0.030	54	35	46
32	40	1 ¼	10	<b>729 910 559</b>	0.046	60	38	55
40	50	1 ½	10	<b>729 910 560</b>	0.072	66	40	65
50	63	2	10	<b>729 910 561</b>	0.125	78	47	80

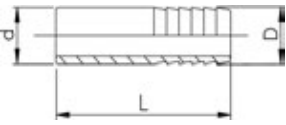

### Hose connector ABS metric

**Model:**

- With solvent cement spigot metric and parallel hose connection

d (mm)	PN (bar)	Code	Weight (kg)	D (mm)	L (mm)
20	10	<b>729 960 406</b>	0.012	20	73
25	10	<b>729 960 407</b>	0.015	25	79
32	10	<b>729 960 408</b>	0.027	30	89
40	10	<b>729 960 409</b>	0.026	40	100
32	10	<b>729 960 508</b>	0.027	32	89

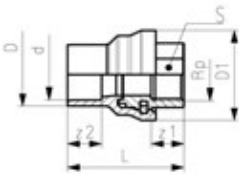

### Adaptor fitting ABS/brass Rp

**Model:**

- Adaptor fitting equally suitable as socket and spigot
- Brass with parallel female thread Rp
- Gasket: O-ring EPDM No. 48 41 01

d (mm)	Rp (inch)	D (mm)	PN (bar)	Code	Weight (kg)	z1 (mm)	z2 (mm)	D1 (mm)	L (mm)	S (mm)
20	½	25	10	<b>729 950 106</b>	0.098	17	17	40	55	25
25	¾	32	10	<b>729 950 107</b>	0.166	19	19	50	65	30
32	1	40	10	<b>729 950 108</b>	0.257	22	23	59	77	36

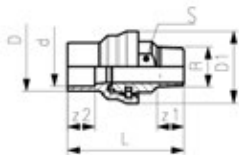

### Adaptor fitting ABS/brass R

**Model:**

- Adaptor fitting equally suitable as socket and spigot
- Brass with taper male thread R
- Gasket: O-ring EPDM No. 48 41 01

d (mm)	R (inch)	D (mm)	PN (bar)	Code	Weight (kg)	z1 (mm)	z2 (mm)	D1 (mm)	L (mm)	S (mm)
20	½	25	10	<b>729 950 606</b>	0.124	17	17	40	70	25
25	¾	32	10	<b>729 950 607</b>	0.221	19	19	50	83	30
32	1	40	10	<b>729 950 608</b>	0.336	22	23	59	96	36

# Flange Adaptors



## Flange adaptor ABS metric

### Model:

- Counter part: Same flange adaptor
- Gasket: profile flange gasket EPDM code no. 748 440 706-723, FPM code no. 749 440 706-723
- Gasket: flat gasket EPDM code no. 748 400 306-323
- Flat sealing faces/serrated
- >d225 - maximum operating temperature: +40°C

### Note:

\* bevel on pipe may be needed if used with butterfly valve type 037/038/039

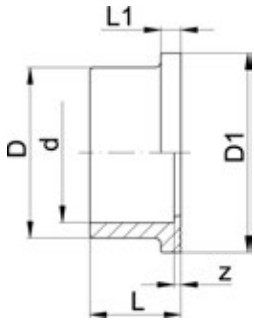

d (mm)	DN (mm)	d (inch)	PN (bar)	Code	Weight (kg)	z (mm)	D (mm)	D1 (mm)	L (mm)	L1 (mm)
20	15		10	<b>729 790 106</b>	0.007	3	27	34	21	6
25	20		10	<b>729 790 107</b>	0.015	3	33	41	24	7
32	25		10	<b>729 790 108</b>	0.020	3	41	50	27	7
40	32		10	<b>729 790 109</b>	0.028	3	50	61	30	8
50	40		10	<b>729 790 110</b>	0.038	3	61	73	34	8
63	50		10	<b>729 790 111</b>	0.068	3	76	90	41	9
75	65	2 ½	10	<b>729 790 112</b>	0.116	3	91	106	47	10
90	80		10	<b>729 790 113</b>	0.185	5	108	125	56	11
110	100		10	<b>729 790 114</b>	0.305	5	131	150	66	12
140	125	5	10	<b>729 790 116</b>	0.535	5	165	188	81	14
*	160	150	10	<b>729 790 117</b>	0.821	5	188	213	91	16
*	200	200	10	<b>729 790 119</b>	1.123	6	224	250	112	24
225	200		10	<b>729 790 120</b>	1.330	6	248	274	125	25
250	250		6	<b>729 790 121</b>	1.699	9	274	303	140	23
280	250		6	<b>729 790 122</b>	2.183	5	307	329	151	23
315	300		6	<b>729 790 123</b>	3.321	8	346	379	172	27

# Unions

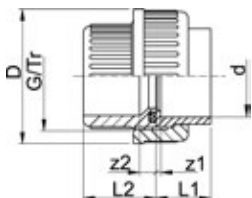

## Union ABS metric

### Model:

- Union End: Solvent cement socket metric
- Union bush: Solvent cement socket metric
- Gasket: O-ring EPDM code no. 748 410 006-016

d (mm)	PN (bar)	Code	Weight (kg)	z1 (mm)	z2 (mm)	D (mm)	L1 (mm)	L2 (mm)	G/Tr (inch)
20	10	729 510 106	0.035	4	10	43	21	26	1
25	10	729 510 107	0.044	5	10	53	24	29	1 1/4
32	10	729 510 108	0.064	5	10	60	27	33	1 1/2
40	10	729 510 109	0.130	3	12	74	31	39	2
50	10	729 510 110	0.154	3	14	83	33	46	2 1/4
63	10	729 510 111	0.258	3	18	103	40	58	2 3/4
75	10	729 510 112	0.469	3	18	135	47	62	Tr 108x5
90	10	729 510 313	0.701	5	18	158	56	69	Tr 128x5
110	10	729 510 114	1.069	5	11	158	66	72	Tr 154x5



## Union end ABS metric

### Model:

- Solvent cement socket metric
- For union 729 510 106-114, 729 510 156-164

d (mm)	PN (bar)	Code	Weight (kg)	z (mm)	D (mm)	D1 (mm)	L (mm)
20	10	729 800 106	0.007	4	30	28	21
25	10	729 800 107	0.012	5	39	36	24
32	10	729 800 108	0.016	5	44	41	27
40	10	729 800 109	0.042	3	57	53	31
50	10	729 800 110	0.045	3	63	59	34
63	10	729 800 111	0.084	3	78	74	41
75	10	729 800 162	0.109	3	101	91	47
90	10	729 800 163	0.178	5	121	108	56
110	10	729 800 164	0.295	5	146	131	66

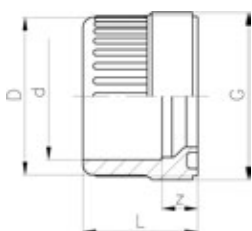

## Union bush ABS metric

### Model:

- Solvent cement socket metric
- For union 729 510 106-114
- Jointing face: With O-Ring groove

d (mm)	PN (bar)	Code	Weight (kg)	z (mm)	D (mm)	L (mm)	G/Tr (inch)
20	10	729 840 106	0.011	10	28	26	1
25	10	729 840 107	0.016	10	33	29	1 1/4
32	10	729 840 108	0.027	10	41	33	1 1/2
40	10	729 840 109	0.046	12	50	39	2
50	10	729 840 110	0.058	14	62	46	2 1/4
63	10	729 840 111	0.110	18	77	58	2 3/4
75	10	729 840 112	0.160	18	93	62	Tr108x5
90	10	729 840 123	0.274	18	110	69	Tr128x5
110	10	729 840 114	0.330	11	133	72	Tr154x6

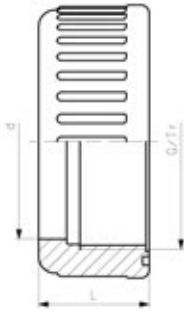

**Union nut ABS**

<b>d</b> (mm)	<b>PN</b> (bar)	<b>Code</b>	<b>Weight</b> (kg)	<b>D</b> (mm)	<b>L</b> (mm)	<b>G/Tr</b> (inch)
16	10	<b>729 890 405</b>	0.009		21	3/4
20	10	<b>729 890 406</b>	0.048	28	23	1
25	10	<b>729 890 407</b>	0.046	36	25	1 1/4
32	10	<b>729 890 408</b>	0.025	42	27	1 1/2
40	10	<b>729 890 409</b>	0.060	53	30	2
50	10	<b>729 890 410</b>	0.100	59	34	2 1/4
63	10	<b>729 890 411</b>	0.147	74	38	2 3/4
75	10	<b>729 690 012</b>	0.192	92	40	Tr108x5
90	10	<b>729 690 013</b>	0.269	110	43	Tr128x5
110	10	<b>729 690 014</b>	0.416	133	48	Tr154x6



# Adaptor Unions



## Adaptor union ABS/malleable iron galvanised metric Rp

### Model:

- Union Nut: ABS
- Union Bush: Solvent cement socket ABS metric
- Union End: malleable iron with parallel female thread Rp
- Gasket: O-ring EPDM code no. 748 410 006-011

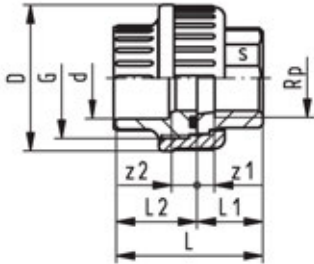

d	Rp	PN*	Code	Weight	z1	z2	D	L	L1	L2	G	s
(mm)	(inch)	(bar)		(kg)	(mm)	(mm)	(mm)	(mm)	(mm)	(mm)	(inch)	(mm)
20	½	10	729 530 306	0.064	9	10	43	48	22	26	1	25
25	¾	10	729 530 307	0.095	7	10	51	51	22	29	1 1/4	31
32	1	10	729 530 308	0.139	9	10	58	58	26	33	1 1/2	38
40	1 ¼	10	729 530 309	0.240	12	12	72	69	31	39	2	48
50	1 ½	10	729 530 310	0.339	14	14	83	78	33	46	2 1/4	54
63	2	10	729 530 311	0.516	11	18	100	91	35	58	2 3/4	67



## Adaptor union ABS/malleable iron galvanised metric R

### Model:

- Union Nut: ABS
- Union Bush: Solvent cement socket ABS metric
- Union End: Malleable iron with taper male thread R
- Gasket: O-ring EPDM code no. 748 410 006-011

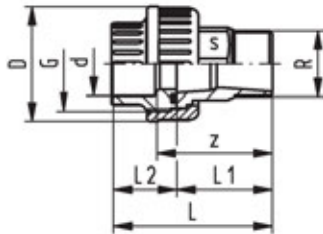

d	R	PN*	Code	Weight	z	D	L	L1	L2	G	s
(mm)	(inch)	(bar)		(kg)	(mm)	(mm)	(mm)	(mm)	(mm)	(inch)	(mm)
20	½	10	729 530 806	0.100	50	43	66	40	26	1	25
25	¾	10	729 530 807	0.147	53	51	72	43	29	1 1/4	31
32	1	10	729 530 808	0.198	58	58	80	48	33	1 1/2	38
40	1 ¼	10	729 530 809	0.400	69	72	95	57	39	2	48
50	1 ½	10	729 530 810	0.490	73	83	104	59	46	2 1/4	54
63	2	10	729 530 811	0.675	80	100	118	62	58	2 3/4	67



## Adaptor union ABS/brass metric Rp

### Model:

- Union Nut: ABS
- Union Bush: Solvent cement socket ABS metric
- Union End: Brass with parallel female thread Rp
- Gasket: O-ring EPDM code no. 748 410 006-011

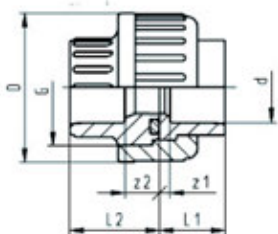

d	Rp	PN	Code	Weight	z1	z2	D	L	L1	L2	G	s
(mm)	(inch)	(bar)		(kg)	(mm)	(mm)	(mm)	(mm)	(mm)	(mm)	(inch)	(mm)
20	½	10	729 550 506	0.084	7	10	43	48	22	26	1	25
25	¾	10	729 550 507	0.134	9	11	51	54	25	29	1 1/4	30
32	1	10	729 550 508	0.179	8	11	58	60	27	33	1 1/2	36
40	1 ¼	10	729 550 509	0.327	10	13	72	70	31	39	2	48
50	1 ½	10	729 550 510	0.452	14	21	83	81	35	46	2 1/4	55
63	2	10	729 550 511	0.674	14	21	100	98	40	58	2 3/4	65

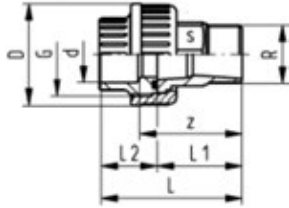

### Adaptor union ABS/brass metric R

#### Model:

- Union Nut: ABS
- Union Bush: Solvent cement socket ABS metric
- Union End: Brass with taper male thread R
- Gasket: O-ring EPDM code no. 748 410 006-011

d	R	PN	Code	Weight	z	D	L	L1	L2	G	s
(mm)	(inch)	(bar)		(kg)	(mm)	(mm)	(mm)	(mm)	(mm)	(inch)	(mm)
20	½	10	<b>729 550 906</b>	0.123	47	43	63	37	26	1	25
25	½	10	<b>729 550 957</b>	0.185	48	51	66	37	29	1 1/4	30
25	¾	10	<b>729 550 907</b>	0.175	52	51	71	42	29	1 1/4	30
25	1	10	<b>729 550 967</b>	0.293	57	51	75	46	29	1 1/4	30
32	½	10	<b>729 550 958</b>	0.283	48	58	70	37	33	1 1/2	36
32	¾	10	<b>729 550 968</b>	0.283	53	58	75	42	33	1 1/2	36
32	1	10	<b>729 550 908</b>	0.374	57	58	79	46	33	1 1/2	36
40	1 ¼	10	<b>729 550 909</b>	0.503	65	72	91	52	39	2	46
50	1 ½	10	<b>729 550 910</b>	0.640	71	83	102	56	46	2 1/4	55
63	2	10	<b>729 550 911</b>	1.019	87	100	125	67	58	2 3/4	65

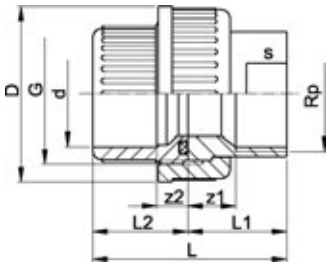

### Adaptor union ABS/stainless steel metric Rp

#### Model:

- Union Nut: ABS
- Union Bush: Solvent cement socket ABS metric
- Union End: Stainless Steel WN 1.4404 (316L), parallel female thread Rp
- Gasket: O-ring EPDM code no. 748 410 006-011

d	Rp	PN	EPDM Code	Weight	z1	z2	D	L	L1	L2	G	s
(mm)	(inch)	(bar)		(kg)	(mm)	(mm)	(mm)	(mm)	(mm)	(mm)	(inch)	(mm)
20	½	10	<b>729 540 206</b>	0.096	11	10	43	50	24	26	1	24
25	¾	10	<b>729 540 207</b>	0.154	11	10	51	55	26	29	1 1/4	29
32	1	10	<b>729 540 208</b>	0.212	12	10	58	61	29	33	1 1/2	36
40	1 ¼	10	<b>729 540 209</b>	0.356	14	12	74	71	33	39	2	45
50	1 ½	10	<b>729 540 210</b>	0.443	15	14	83	79	34	46	2 1/4	54
63	2	10	<b>729 540 211</b>	0.721	15	18	100	95	39	58	2 3/4	63

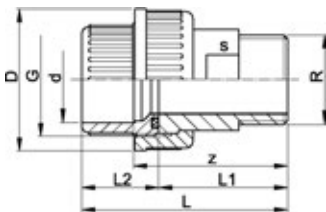

### Adaptor union ABS/stainless steel metric R

#### Model:

- Union Nut: ABS
- Union Bush: Solvent cement socket ABS metric
- Union End: Stainless Steel WN 1.4404 (316L), taper male thread R
- Gasket: O-ring EPDM code no. 748 410 006-011

d	R	PN	EPDM Code	Weight	z	D	L	L1	L2	G	s
(mm)	(inch)	(bar)		(kg)	(mm)	(mm)	(mm)	(mm)	(mm)	(inch)	(mm)
20	½	10	<b>729 540 706</b>	0.106	44	43	60	34	26	1	24
25	¾	10	<b>729 540 707</b>	0.174	46	51	65	36	29	1 1/4	32
32	1	10	<b>729 540 708</b>	0.262	50	58	72	40	33	1 1/2	37
40	1 ¼	10	<b>729 540 709</b>	0.476	58	74	84	46	39	2	48
50	1 ½	10	<b>729 540 710</b>	0.535	62	83	93	48	46	2 1/4	54
63	2	10	<b>729 540 711</b>	0.861	73	100	111	55	58	2 3/4	69



### Adaptor union ABS/stainless steel metric Welding end

#### Model:

- Union End: Stainless Steel WN 1.4404 (316L) with welding end
- Union Bush: Solvent cement socket ABS metric
- Union Nut: Stainless Steel WN 1.4404 (316L)
- Gasket: O-ring EPDM code no. 748 410 006-011

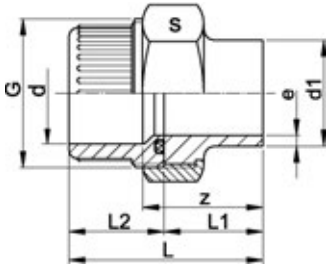

d	d1	PN	EPDM	Weight	z	L	L1	L2	e	G	s
(mm)	(mm)	(bar)	Code	(kg)	(mm)	(mm)	(mm)	(mm)	(mm)	(inch)	(mm)
20	21	10	<b>729 545 506</b>	0.176	32	48	22	26	2.0	1	41
25	27	10	<b>729 545 507</b>	0.204	33	52	23	29	2.0	1 1/4	46
32	34	10	<b>729 545 508</b>	0.313	36	58	26	33	2.0	1 1/2	55
40	42	10	<b>729 545 509</b>	0.493	38	64	26	39	2.0	2	68
50	48	10	<b>729 545 510</b>	0.566	42	73	28	46	2.0	2 1/4	74
63	60	10	<b>729 545 511</b>	0.902	50	88	32	58	2.6	2 3/4	88



### Adaptor union ABS/copper for soldering metric

#### Model:

- Union End: Copper
- Union Bush: Solvent cement socket ABS metric
- Union Nut: brass
- Gasket: O-ring EPDM code no. 748 410 006-011

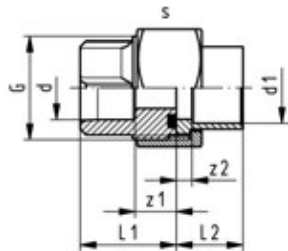

d	d1	PN	Code	Weight	z1	z2	L1	L2	G	s
(mm)	(mm)	(bar)		(kg)	(mm)	(mm)	(mm)	(mm)	(inch)	(mm)
20	22	10	<b>720 510 106</b>	0.140	9	3	26	19	1	40
25	28	10	<b>720 510 107</b>	0.269	9	6	29	28	1 1/4	50
32	35	10	<b>720 510 108</b>	0.198	10	5	33	27	1 1/2	52
40	42	10	<b>720 510 109</b>	0.350	12	6	39	35	2	66
50	54	10	<b>720 510 110</b>	0.438	14	3	46	46	2 1/4	72

# Branch Saddles

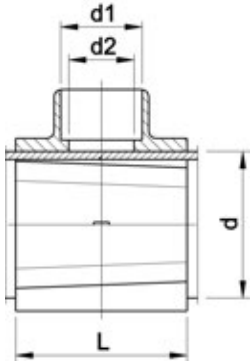

## Branch saddle ABS metric

### Model:

- For ABS-pipes
- Outlet with solvent cement socket metric
- PN 10
- Top saddle (ABS) for solvent cementing
- Bottom part and wedges made from PVC-U

d (mm)	PN* (bar)	Code	Weight (kg)	d1 (mm)	d2 (mm)	L (mm)	Tapping-Ø (mm)
90	10	<b>169 110 056</b>	0.786	50	40	105	39
110	10	<b>169 110 066</b>	0.864	50	40	105	39
160	10	<b>169 110 097</b>	1.329	63	49	120	48
225	10	<b>169 110 117</b>	1.587	63	49	120	48

## 654 - Blue clamp saddles with stainless steel reinforcing ring, flat gasket and galvanized bolts and nuts (PN16-PN10)



- bolts and nuts : galvanized
- colour: blue
- B= N° of bolts
- M= bolt type
- (\*) with O-ring gasket
- water PN16-10
- female thread: ISO 7 (parallel)
- gasket: O-ring with flat lip (NBR)
- material: PP
- reinforcement ring: stainless steel AISI430

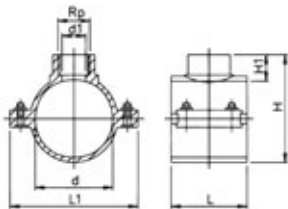

	d (mm)	Rp (inch)	PN (bar)	B	M	Code	Weight (kg)	d1 (mm)	L (mm)	L1 (mm)	H (mm)	H1 (mm)
*	20	½	16	2	M8X40	<b>158 001 041</b>	0.119	12	46	77	59	26
*	25	½	16	2	M8X30	<b>158 001 042</b>	0.110	13	49	79	58	15
*	25	¾	16	2	M8X30	<b>158 001 043</b>	0.123	13	49	79	58	15
*	32	½	16	2	M8X30	<b>158 001 044</b>	0.103	14	49	79	62	20
*	32	¾	16	2	M8X30	<b>158 001 045</b>	0.115	14	49	79	62	20
*	32	1	16	2	M8X40	<b>158 001 046</b>	0.162	14	62	87	70	20
	40	½	16	2	M8X40	<b>158 001 047</b>	0.135	21	62	86	71	20
	40	¾	16	2	M8X40	<b>158 001 048</b>	0.146	21	62	86	71	20
	40	1	16	2	M8X40	<b>158 001 049</b>	0.153	21	62	86	70	19
	50	½	16	4	M8X40	<b>158 001 050</b>	0.196	21	62	86	82	20
	50	¾	16	4	M8X40	<b>158 001 051</b>	0.209	21	62	86	82	20
	50	1	16	4	M8X40	<b>158 001 052</b>	0.217	21	62	86	82	20
	50	1 ¼	16	4	M8X40	<b>158 001 053</b>	0.221	21	62	86	82	20
	63	½	16	4	M8X40	<b>158 001 054</b>	0.212	18	62	101	96	21
	63	¾	16	4	M8X40	<b>158 001 055</b>	0.222	24	62	101	96	21
	63	1	16	4	M8X40	<b>158 001 056</b>	0.228	31	62	101	96	21
	63	1 ¼	16	4	M8X40	<b>158 001 058</b>	0.268	31	62	101	96	21
	63	1 ½	16	4	M8X40	<b>158 001 057</b>	0.275	31	62	101	96	21
	75	½	16	4	M8X60	<b>158 001 059</b>	0.364	16	79	123	102	14
	75	¾	16	4	M8X60	<b>158 001 060</b>	0.376	21	79	123	104	16
	75	1	16	4	M8X60	<b>158 001 061</b>	0.384	27	79	123	107	19
	75	1 ¼	16	4	M8X60	<b>158 001 063</b>	0.421	35	79	123	109	21
	75	1 ½	16	4	M8X60	<b>158 001 062</b>	0.428	42	79	123	109	21
	75	2	16	4	M8X60	<b>158 001 064</b>	0.437	53	79	123	112	24
	90	½	16	4	M8X60	<b>158 001 065</b>	0.412	16	87	138	116	14

table continued on the next page

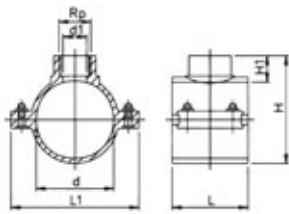

	d (mm)	Rp (inch)	PN (bar)	B	M	Code	Weight (kg)	d1 (mm)	L (mm)	L1 (mm)	H (mm)	H1 (mm)
	90	¾	16	4	M8X60	158 001 066	0.421	21	87	138	118	16
	90	1	16	4	M8X60	158 001 067	0.432	27	87	138	121	19
	90	1 ¼	16	4	M8X60	158 001 069	0.472	35	87	138	123	21
	90	1 ½	16	4	M8X60	158 001 068	0.474	42	87	138	123	21
	90	2	16	4	M8X60	158 001 070	0.481	53	87	138	126	24
	110	½	16	6	M8X50	158 001 071	0.511	15	99	152	150	23
	110	¾	16	6	M8X50	158 001 072	0.523	20	99	152	150	23
	110	1	16	6	M8X50	158 001 073	0.533	26	99	152	150	23
	110	1 ¼	16	6	M8X50	158 001 075	0.565	35	99	152	150	23
	110	1 ½	16	6	M8X50	158 001 074	0.566	41	99	152	150	23
	110	2	16	6	M8X50	158 001 076	0.570	51	99	152	150	23
	110	3	6	6	M8x70	158 001 077	1.108	85	99	152	150	23
	125	½	16	6	M8X50	158 001 078	0.578	15	101	166	169	24
	125	¾	16	6	M8X50	158 001 079	0.590	20	101	166	169	24
	125	1	16	6	M8X50	158 001 080	0.592	26	101	166	169	24
	125	1 ¼	16	6	M8X50	158 001 082	0.629	35	101	166	168	23
	125	1 ½	16	6	M8X50	158 001 081	0.627	41	101	166	168	23
	125	2	16	6	M8X50	158 001 083	0.640	50	101	166	168	23
	125	3	6	6	M8X70	158 001 084	1.009	85	139	178	180	37
	125	4	6	6	M8X70	158 001 085	1.051	90	139	178	181	38
	140	½	16	6	M8X70	158 001 086	0.830	18	114	207	191	25
	140	¾	16	6	M8X70	158 001 087	0.843	24	114	207	191	25
	140	1	16	6	M8X70	158 001 088	0.849	30	114	207	191	25
	140	1 ¼	16	6	M8X70	158 001 090	0.880	38	114	207	191	25
	140	1 ½	16	6	M8X70	158 001 089	0.892	45	114	207	191	24
	140	2	16	6	M8X70	158 001 091	0.898	50	114	207	191	24
	140	3	10	6	M8X70	158 001 092	1.132	85	142	208	201	38
	140	4	10	6	M8X70	158 001 093	1.196	90	142	208	201	38
	160	½	16	6	M8X70	158 001 094	0.899	18	114	226	215	24
	160	¾	16	6	M8X70	158 001 095	0.908	24	114	226	215	24
	160	1	16	6	M8X70	158 001 096	0.917	30	114	226	215	24
	160	1 ¼	16	6	M8X70	158 001 098	0.950	37	114	226	215	24
	160	1 ½	16	6	M8X70	158 001 097	0.954	45	114	226	215	24
	160	2	16	6	M8X70	158 001 099	0.956	51	114	226	215	24
	160	3	10	6	M8X70	158 001 100	1.185	84	142	228	222	38
	160	4	10	6	M8X70	158 001 101	1.262	90	142	228	222	38
*	180	1	10	6	M10X80	158 001 102	1.980	30	169	262	265	38
*	180	1 ½	10	6	M10X80	158 001 103	2.007	54	169	262	265	38
*	180	1 ¼	10	6	M10X80	158 001 104	2.013	36	169	262	265	38
*	180	2	10	6	M10X80	158 001 105	2.018	54	169	262	265	38
*	180	3	10	6	M10X80	158 001 106	2.043	85	169	262	265	38
*	180	4	10	6	M10X80	158 001 107	2.092	103	169	262	267	40
*	200	1 ½	10	6	M10X80	158 001 108	1.966	45	169	262	265	38
*	200	2	10	6	M10X80	158 001 109	1.946	54	169	262	265	38
*	200	3	10	6	M10X80	158 001 110	1.980	85	169	262	265	38
*	200	4	10	6	M10X80	158 001 111	2.020	103	169	262	267	40
*	225	1 ½	10	6	M10X80	158 001 112	2.049	45	145	287	287	26
*	225	2	10	6	M10X80	158 001 113	2.050	51	145	287	287	26
*	225	3	10	6	M10X80	158 001 114	2.150	85	174	287	295	37
*	225	4	10	6	M10X80	158 001 115	2.184	103	174	287	295	38
*	250	2	10	6	M10X80	158 001 116	2.472	55	178	310	314	38
*	250	3	10	6	M10X80	158 001 117	2.466	85	178	310	314	38
*	250	4	10	6	M10X80	158 001 118	2.478	103	178	310	314	38
	280	2	10	6	M10X160	158 001 119	3.440	51	179	335	326	31
*	280	3	10	6	M10X160	158 001 120	3.543	78	179	335	338	41
*	280	4	10	6	M10X160	158 001 121	3.585	98	179	335	338	46
	315	2	10	6	M10X110	158 001 122	4.156	51	246	390	350	31
*	315	3	10	6	M10X110	158 001 123	4.267	78	246	390	363	41
*	315	4	10	6	M10X110	158 001 124	4.279	98	246	390	363	46



## GF Ball Valve Labelling

# The Simple Way to Identify Your Ball Valves Individually

Identify the ball valves in your piping systems clearly and easily with the GF Ball Valve Labelling. Whether to comply with standards or for more clarity - you decide how to label your ball valves.

### Benefits

- Increased safety for piping system and operator
- Improved efficiency of operation and maintenance
- Customised system identification

### Specifications

- For GF Ball Valve Types 546, 523, 543 and 547
- Lever clip material: SAN
- Print sheet A4: Polymer foil

### Product features

- UV, weather and chemical resistant
- Can be labelled with laser printers or by hand

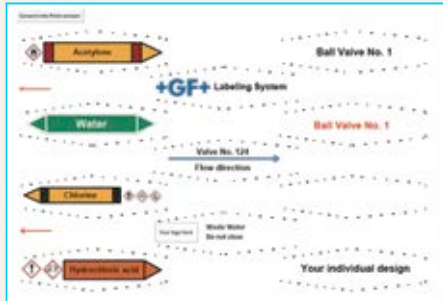

### Step One

Design your personalised label



### Step Two

Print your label

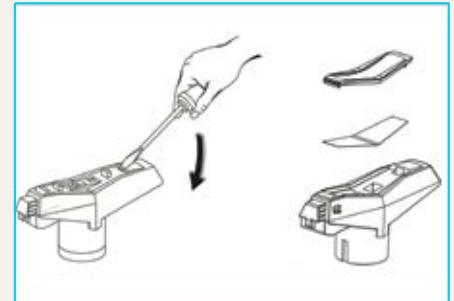

### Step Three









Fit your label

### Printing Sheets for ball valve labelling

Inch (inch)	d-d (mm)	DN-DN (mm)	Code	Quantity
3/8 - 1/2	16 - 20	10 - 15	198 807 231	25 sheets with each 48 labels
3/4 - 1	25 - 32	20 - 25	198 807 232	25 sheets with each 24 labels
1 1/4 - 1 1/2	40 - 50	32 - 40	198 807 233	25 sheets with each 18 labels
2	63	50	198 807 234	25 sheets with each 11 labels

### Transparent lever clip for ball valve labelling

Inch (inch)	d-d (mm)	DN-DN (mm)	Code	Quantity
3/8 - 1/2	16 - 20	10 - 15	198 807 221	10 pc's
3/4 - 1	25 - 32	20 - 25	198 807 222	10 pc's
1 1/4 - 1 1/2	40 - 50	32 - 40	198 807 223	5 pc's
2	63	50	198 807 224	5 pc's

 DN10/15 - 50	Ball Valves	46
	Diaphragm Valves	71
	Butterfly Valves	74
	Angle Seat Check Valves	87
	Cone Check (non-return) Valves	88
	Process Control Valves	91
	Strainers	93
	Variable Area Flow Meters	95



# Ball Valves

## Ball Valves Type 546

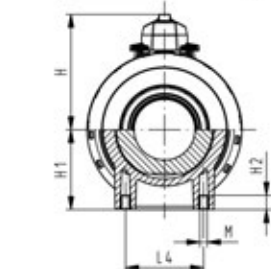
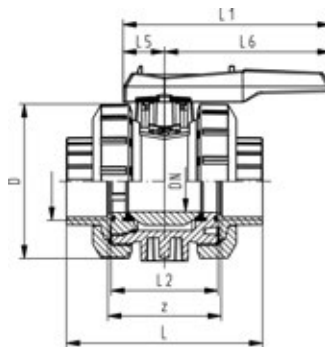
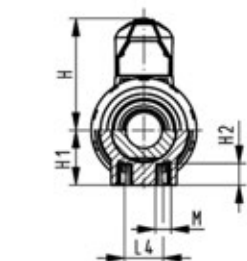
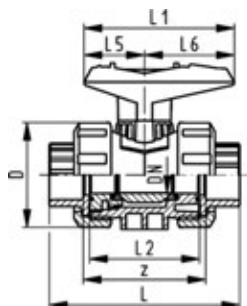

**Ball valve type 546 ABS**  
**With mounting inserts**  
**With solvent cement sockets BS Inch**

**Model:**

- For easy installation and removal
- Ball seals PTFE
- Integrated stainless steel mounting inserts
- z-dimension, valve end and union nut are **not compatible** with type 346 (DN10/15-50) resp. type 370 (DN65-100)

**Option:**

- Individual configuration of the valve (see diagram)
- Multifunctional module with integrated limit switches
- Pneumatic or electric actuators from GF

Size (inch)	DN (mm)	PN (bar)	kv-value ( $\Delta p=1$ bar) (L/min)	EPDM Code	Weight (kg)
3/8	10	10	71	<b>169 546 241</b>	0.112
1/2	15	10	185	<b>169 546 242</b>	0.114
3/4	20	10	350	<b>169 546 243</b>	0.178
1	25	10	700	<b>169 546 244</b>	0.258
1 1/4	32	10	1000	<b>169 546 245</b>	0.457
1 1/2	40	10	1600	<b>169 546 246</b>	0.642
2	50	10	3100	<b>169 546 247</b>	1.175
	65	10	5000	<b>169 546 068</b>	3.463
3	80	10	7000	<b>169 546 249</b>	4.120
4	100	10	11000	<b>169 546 250</b>	9.100

Size (inch)	D (mm)	H (mm)	H1 (mm)	H2 (mm)	L (mm)	L1 (mm)	L2 (mm)	L4 (mm)	L5 (mm)	L6 (mm)	M	z (mm)
3/8	50	57	27	12	92	77	56	25	32	45	M6	60
1/2	50	57	27	12	95	77	56	25	32	45	M6	60
3/4	58	67	30	12	110	97	65	25	39	58	M6	69
1	68	73	36	12	123	97	71	25	39	58	M6	75
1 1/4	84	90	44	15	146	128	85	45	54	74	M8	89
1 1/2	97	97	51	15	157	128	89	45	54	74	M8	97
2	124	116	64	15	183	152	101	45	66	87	M8	110
	166	149	85	15	233	270	136	70	64	206	M8	144
3	200	161	105	15	254	270	141	70	64	206	M8	151
4	238	178	123	22	301	320	164	120	64	256	M12	174



**Ball valve type 546 ABS**  
**With lockable handle**  
**With solvent cement sockets BS Inch**

**Model:**

- For easy installation and removal
- Ball seals PTFE
- Integrated stainless steel mounting inserts
- z-dimension, valve end and union nut are **not compatible** with type 346 (DN10/15-50) resp. type 370 (DN65-100)
- Lockable hand lever with ratchet settings

**Option:**

- Individual configuration of the valve (see diagram)
- Multifunctional module with integrated limit switches
- Pneumatic or electric actuators from GF

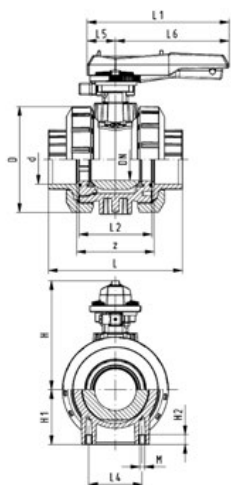
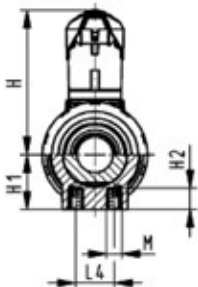
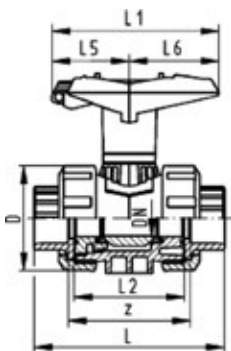

Size (inch)	DN (mm)	PN (bar)	kv-value ( $\Delta p=1$ bar) (l/min)	EPDM Code	Weight (kg)
3/8	10	10	71	<b>169 546 221</b>	0.121
1/2	15	10	185	<b>169 546 222</b>	0.123
3/4	20	10	350	<b>169 546 223</b>	0.193
1	25	10	700	<b>169 546 224</b>	0.273
1 1/4	32	10	1000	<b>169 546 225</b>	0.480
1 1/2	40	10	1600	<b>169 546 226</b>	0.665
2	50	10	3100	<b>169 546 227</b>	1.205
2 1/2	65	10	5000	<b>169 546 088</b>	4.200
3	80	10	7000	<b>169 546 229</b>	6.100
4	100		11000	<b>169 546 230</b>	9.400

Size (inch)	D (mm)	H (mm)	H1 (mm)	H2 (mm)	L (mm)	L1 (mm)	L2 (mm)	L4 (mm)	L5 (mm)	L6 (mm)	M	z (mm)
3/8	50	79	27	12	92	87	56	25	42	45	M6	60
1/2	50	79	27	12	95	87	56	25	42	45	M6	60
3/4	58	88	30	12	110	108	65	25	50	58	M6	69
1	68	94	36	12	123	108	71	25	50	58	M6	75
1 1/4	84	113	44	15	146	140	85	45	66	75	M8	89
1 1/2	97	119	51	15	157	140	89	45	66	75	M8	97
2	124	141	64	15	183	165	101	45	78	87	M8	110
2 1/2	166	224	85	15	233	270	136	70	64	206	M8	144
3	200	235	105	15	254	270	141	70	64	206	M8	151
4	238	245	123	22	301	320	164	120	64	256	M12	174

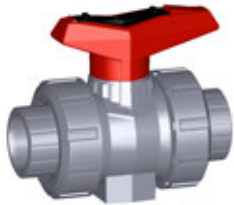

DN10/15 - 50



**Ball valve type 546 ABS**  
**With mounting inserts**  
**With solvent cement sockets metric**

**Model:**

- For easy installation and removal
- Ball seals PTFE
- Integrated stainless steel mounting inserts
- z-dimension, valve end and union nut are **not compatible** with type 346 (DN10/15-50) resp. type 370 (DN65-100)

**Option:**

- Individual configuration of the valve (see diagram)
- Multifunctional module with integrated limit switches
- Pneumatic or electric actuators from GF

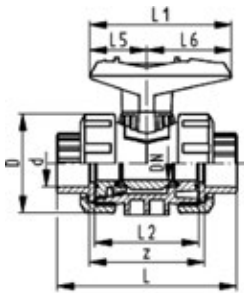

d (mm)	DN (mm)	PN (bar)	kv-value ( $\Delta p=1$ bar) (l/min)	EPDM Code	Weight (kg)
16	10	10	71	169 546 061	0.112
20	15	10	185	169 546 062	0.114
25	20	10	350	169 546 063	0.188
32	25	10	700	169 546 064	0.272
40	32	10	1000	169 546 065	0.481
50	40	10	1600	169 546 066	0.657
63	50	10	3100	169 546 067	1.200
75	65	10	5000	169 546 068	3.463
90	80	10	7000	169 546 069	5.700
110	100	10	11000	169 546 070	6.985

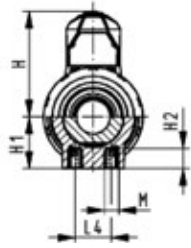

d (mm)	D (mm)	H (mm)	H1 (mm)	H2 (mm)	L (mm)	L1 (mm)	L2 (mm)	L4 (mm)	L5 (mm)	L6 (mm)	M	z (mm)
16	50	57	27	12	92	77	56	25	32	45	M6	64
20	50	57	27	12	95	77	56	25	32	45	M6	64
25	58	67	30	12	110	97	65	25	39	58	M6	72
32	68	73	36	12	123	97	71	25	39	58	M6	79
40	84	90	44	15	146	128	85	45	54	74	M8	94
50	97	97	51	15	157	128	89	45	54	74	M8	95
63	124	116	64	15	183	152	101	45	66	87	M8	107
75	166	149	85	15	233	270	136	70	64	206	M8	144
90	200	161	105	15	254	270	141	70	64	206	M8	151
110	238	178	123	22	301	320	164	120	64	256	M12	174

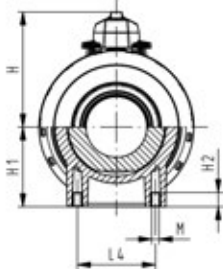
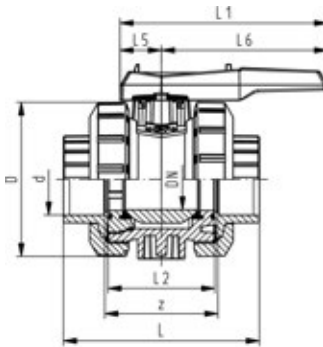

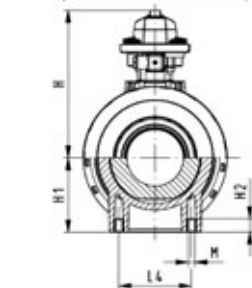
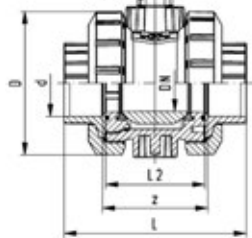
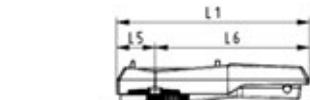
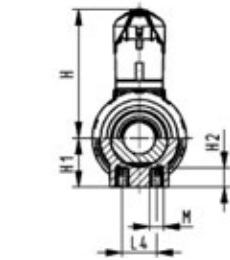
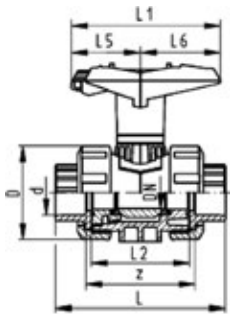

**Ball valve type 546 ABS**  
**With lockable handle**  
**With solvent cement sockets metric**

**Model:**

- For easy installation and removal
- Ball seals PTFE
- Integrated stainless steel mounting inserts
- z-dimension, valve end and union nut are **not compatible** with type 346 (DN10/15-50) resp. type 370 (DN65-100)
- Lockable hand lever with ratchet settings

**Option:**

- Individual configuration of the valve (see diagram)
- Multifunctional module with integrated limit switches
- Pneumatic or electric actuators from GF

d (mm)	DN (mm)	PN (bar)	kv-value ( $\Delta p=1$ bar) (l/min)	EPDM Code	Weight (kg)
16	10	10	71	169 546 081	0.121
20	15	10	185	169 546 082	0.123
25	20	10	350	169 546 083	0.193
32	25	10	700	169 546 084	0.273
40	32	10	1000	169 546 085	0.480
50	40	10	1600	169 546 086	0.665
63	50	10	3100	169 546 087	1.205
75	65	10	5000	169 546 088	4.200
90	80	10	7000	169 546 089	6.100
110	100	10	11000	169 546 090	9.400

d (mm)	D (mm)	H (mm)	H1 (mm)	H2 (mm)	L (mm)	L1 (mm)	L2 (mm)	L4 (mm)	L5 (mm)	L6 (mm)	M	z (mm)
16	50	79	27	12	92	87	56	25	42	45	M6	64
20	50	79	27	12	95	87	56	25	42	45	M6	64
25	58	88	30	12	110	108	65	25	50	58	M6	72
32	68	94	36	12	123	108	71	25	50	58	M6	79
40	84	113	44	15	146	140	85	45	66	75	M8	94
50	97	119	51	15	157	140	89	45	66	75	M8	95
63	124	141	64	15	183	165	101	45	78	87	M8	107
75	166	224	85	15	233	270	136	70	64	206	M8	144
90	200	235	105	15	254	270	141	70	64	206	M8	151
110	238	245	123	22	301	320	164	120	64	256	M12	174

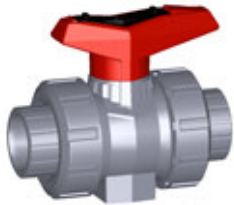

DN10/15 - 50

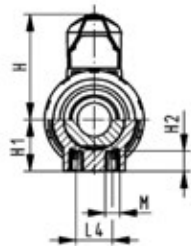
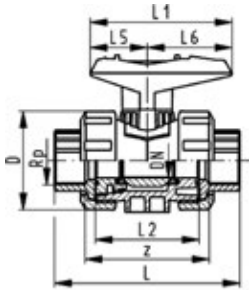

**Ball valve type 546 ABS**  
**With mounting inserts**  
**With threaded sockets Rp**

**Model:**

- For easy installation and removal
- Ball seals PTFE
- Integrated stainless steel mounting inserts
- z-dimension, valve end and union nut are not compatible with type 346

**Option:**

- Individual configuration of the valve (see diagram)
- Multifunctional module with integrated limit switches
- Pneumatic or electric actuators from GF

Rp	DN	PN	kv-value	EPDM	Weight
(inch)	(mm)	(bar)	( $\Delta p=1$ bar)	Code	(kg)
			(l/min)		
3/8	10	10	71	<b>169 546 021</b>	0.112
1/2	15	10	185	<b>169 546 022</b>	0.114
3/4	20	10	350	<b>169 546 023</b>	0.178
1	25	10	700	<b>169 546 024</b>	0.258
1 1/4	32	10	1000	<b>169 546 025</b>	0.457
1 1/2	40	10	1600	<b>169 546 026</b>	0.642
2	50	10	3100	<b>169 546 027</b>	1.175

Rp	D	H	H1	H2	L	L1	L2	L4	L5	L6	M	z
(inch)	(mm)	(mm)	(mm)	(mm)	(mm)	(mm)	(mm)	(mm)	(mm)	(mm)		(mm)
3/8	50	57	27	12	95	77	56	25	32	45	M6	69
1/2	50	57	27	12	100	77	56	25	32	45	M6	67
3/4	58	67	30	12	114	97	65	25	39	58	M6	78
1	68	73	36	12	127	97	71	25	39	58	M6	85
1 1/4	84	90	44	15	146	128	85	45	54	74	M8	100
1 1/2	97	97	51	15	152	128	89	45	54	74	M8	106
2	124	116	64	15	177	152	101	45	66	87	M8	121



DN10/15 - 50

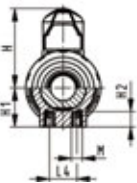
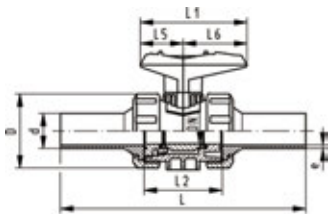

**Ball valve type 546 ABS**  
**With mounting inserts**  
**With butt fusion spigots long PE100 SDR11 metric**

**Model:**

- Material: ABS/PE
- For easy installation and removal
- Ball seals PTFE
- Integrated stainless steel mounting inserts
- z-dimension, valve end and union nut are **not compatible** with type 346 (DN10/15-50) resp. type 370 (DN65-100)

**Option:**

- Individual configuration of the valve (see diagram)
- Multifunctional module with integrated limit switches
- Pneumatic or electric actuators from GF

d	DN	PN	kv-value	EPDM	Weight
(mm)	(mm)	(bar)	( $\Delta p=1$ bar)	Code	(kg)
			(l/min)		
20	15	10	185	<b>800 024 832</b>	0.150
25	20	10	350	<b>800 024 834</b>	0.220
32	25	10	700	<b>800 015 141</b>	0.310
40	32	10	1000	<b>800 015 142</b>	0.530
50	40	10	1600	<b>800 015 179</b>	0.740
63	50	10	3100	<b>800 015 143</b>	1.370
75	65	10	5000	<b>800 045 326</b>	3.900
90	80	10	7000	<b>800 045 327</b>	3.900
110	100	10	11000	<b>800 045 328</b>	3.900

table continued on the next page

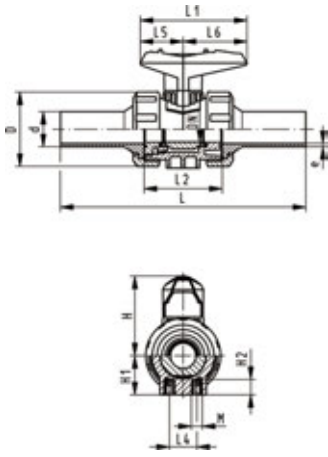

<b>d</b>	<b>D</b>	<b>H</b>	<b>H1</b>	<b>H2</b>	<b>L</b>	<b>L1</b>	<b>L2</b>	<b>L4</b>	<b>L5</b>	<b>L6</b>	<b>M</b>	<b>e</b>
(mm)	(mm)	(mm)	(mm)	(mm)	(mm)	(mm)	(mm)	(mm)	(mm)	(mm)		(mm)
20	50	57	27	12	193	77	56	25	32	45	M6	1.9
25	58	67	30	12	216	97	65	25	39	58	M6	2.3
32	68	73	36	12	223	97	71	25	39	58	M6	2.9
40	84	90	44	15	249	128	85	45	54	74	M8	3.7
50	97	97	51	15	271	128	89	45	54	74	M8	4.6
63	124	116	64	15	321	152	101	45	66	87	M8	5.8
75	166	149	85	15	386	270	136	70	64	206	M8	6.8
90	200	161	105	15	421	270	141	70	64	206	M8	8.2
110	238	178	123	22	484	320	164	120	64	256	M12	10.0

# 3-Way Ball Valves Type 543

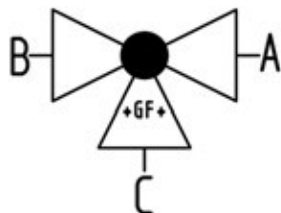

## 3-Way ball valve type 543 ABS Horizontal/L-port With solvent cement sockets BS

### Model:

- For easy installation and removal (valve end and union nut are compatible with type 546)
- Ball seals PTFE
- Pneumatic or electric actuator available separately
- Angle of operation 360° without turn limiter
- Turn limiter 90° enclosed, in different positions usable as a clip-on ring
- Integrated stainless steel mounting inserts
- Delivery status A-C opened, see flow scheme

Size (inch)	DN (mm)	PN (bar)	kv-value ( $\Delta p=1$ bar) (l/min)	EPDM Code	Weight (kg)
3/8	10	10	50	<b>169 543 061</b>	0.187
1/2	15	10	75	<b>169 543 062</b>	0.181
3/4	20	10	150	<b>169 543 063</b>	0.263
1	25	10	280	<b>169 543 064</b>	0.402
1 1/4	32	10	480	<b>169 543 065</b>	0.716
1 1/2	40	10	620	<b>169 543 066</b>	1.061
2	50	10	1230	<b>169 543 067</b>	2.064

Size (inch)	D (mm)	H (mm)	H1 (mm)	H2 (mm)	L (mm)	L1 (mm)	L2 (mm)	L3 (mm)	L4 (mm)	L5 (mm)	L6 (mm)	M (mm)	z (mm)	z1 (mm)
3/8	50	57	28	8	109	77	73	36	25	32	45	6	77	38
1/2	50	57	28	8	112	77	73	36	25	32	45	6	77	38
3/4	58	67	32	8	131	97	86	43	25	39	58	6	90	45
1	68	73	36	8	151	97	99	50	25	39	58	6	103	52
1 1/4	84	90	45	9	181	128	120	60	45	54	74	8	124	62
1 1/2	97	97	51	9	205	128	137	69	45	54	74	8	145	73
2	124	116	65	9	261	152	179	89	45	66	87	8	189	94

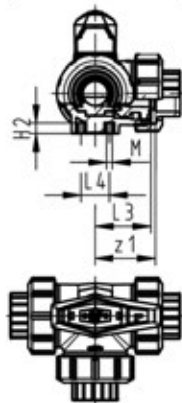
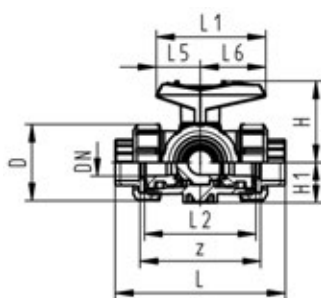



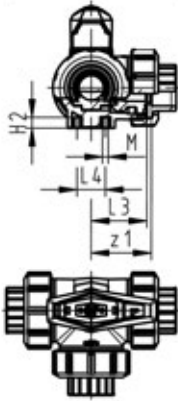
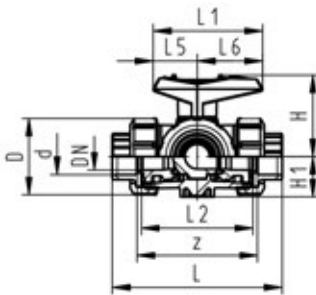
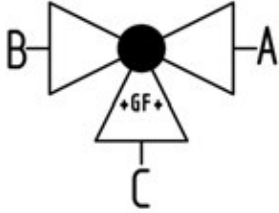

### 3-Way ball valve type 543 ABS Horizontal/L-port With solvent cement sockets metric

#### Model:

- For easy installation and removal (valve end and union nut are compatible with type 546)
- Ball seals PTFE
- Pneumatic or electric actuator available separately
- Angle of operation 360° without turn limiter
- Turn limiter 90° enclosed, in different positions usable as a clip-on ring
- Integrated stainless steel mounting inserts
- Delivery status A-C opened, see flow scheme

d (mm)	DN (mm)	PN (bar)	kv-value ( $\Delta p=1$ bar) (l/min)	EPDM Code	Weight (kg)
16	10	10	50	<b>169 543 001</b>	0.187
20	15	10	75	<b>169 543 002</b>	0.174
25	20	10	150	<b>169 543 003</b>	0.276
32	25	10	280	<b>169 543 004</b>	0.403
40	32	10	480	<b>169 543 005</b>	0.707
50	40	10	620	<b>169 543 006</b>	1.059
63	50	10	1230	<b>169 543 007</b>	2.062

d (mm)	D (mm)	H (mm)	H1 (mm)	H2 (mm)	L (mm)	L1 (mm)	L2 (mm)	L3 (mm)	L4 (mm)	L5 (mm)	L6 (mm)	M (mm)	z (mm)	z1 (mm)
16	50	57	28	8	109	77	73	36	25	32	45	6	81	40
20	50	57	28	8	112	77	73	36	25	32	45	6	81	40
25	58	67	32	8	131	97	86	43	25	39	58	6	94	47
32	68	73	36	8	151	97	99	50	25	39	58	6	107	54
40	84	90	45	9	181	128	120	60	45	54	74	8	130	65
50	97	97	51	9	205	128	137	69	45	54	74	8	143	72
63	124	116	65	9	261	152	179	89	45	66	87	8	185	92



**3-Way ball valve type 543 ABS**  
**Horizontal/L-port**  
**With threaded sockets Rp**

**Model:**

- For easy installation and removal (valve end and union nut are compatible with type 546)
- Ball seals PTFE
- Pneumatic or electric actuator available separately
- Angle of operation 360° without turn limiter
- Turn limiter 90° enclosed, in different positions usable as a clip-on ring
- Integrated stainless steel mounting inserts
- Delivery status A-C opened, see flow scheme

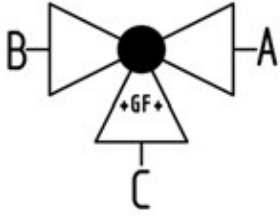

Rp (inch)	DN (mm)	PN (bar)	kv-value ( $\Delta p=1$ bar) (l/min)	EPDM Code	Weight (kg)
3/8	10	10	50	<b>169 543 041</b>	0.187
1/2	15	10	75	<b>169 543 042</b>	0.192
3/4	20	10	150	<b>169 543 043</b>	0.276
1	25	10	280	<b>169 543 044</b>	0.420
1 1/4	32	10	480	<b>169 543 045</b>	0.716
1 1/2	40	10	620	<b>169 543 046</b>	1.061
2	50	10	1230	<b>169 543 047</b>	2.064

Rp (inch)	D (mm)	H (mm)	H1 (mm)	H2 (mm)	L (mm)	L1 (mm)	L2 (mm)	L3 (mm)	L4 (mm)	L5 (mm)	L6 (mm)	M (mm)	z (mm)	z1 (mm)
3/8	50	57	28	8	113	77	73	36	25	32	45	6	87	43
1/2	50	57	28	8	117	77	73	36	25	32	45	6	85	42
3/4	58	67	32	8	135	97	86	43	25	39	58	6	100	50
1	68	73	36	8	155	97	99	50	25	39	58	6	113	57
1 1/4	84	90	45	9	179	128	120	60	45	54	74	8	134	67
1 1/2	97	97	51	9	201	128	137	69	45	54	74	8	155	78
2	124	116	65	9	255	152	179	89	45	66	87	8	199	99

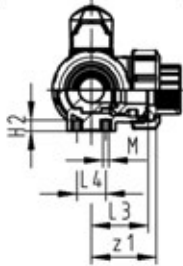
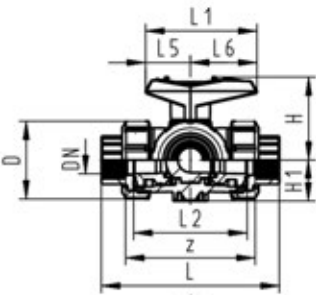



**3-Way ball valve type 543 ABS**  
**Horizontal/L-port**  
**With butt fusion spigots long**  
**PE100 SDR11 metric**

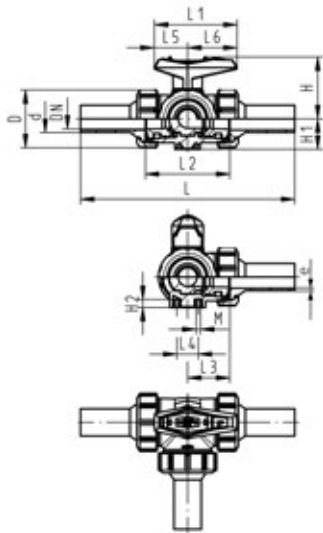
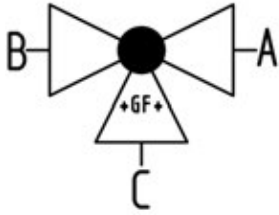

**Model:**

- Material: ABS/PE
- For easy installation and removal (valve end and union nut are compatible with type 546)
- Ball seals PTFE
- Pneumatic or electric actuator available separately
- Angle of operation 360° without turn limiter
- Turn limiter 90° enclosed, in different positions usable as a clip-on ring
- Integrated stainless steel mounting inserts
- Delivery status A-C opened, see flow scheme

d (mm)	DN (mm)	PN (bar)	kv-value ( $\Delta p=1$ bar) (l/min)	EPDM Code	Weight (kg)
20	15	10	75	<b>169 543 302</b>	0.203
25	20	10	150	<b>169 543 303</b>	0.296
32	25	10	280	<b>169 543 304</b>	0.450
40	32	10	480	<b>169 543 305</b>	0.762
50	40	10	620	<b>169 543 306</b>	1.161
63	50	10	1230	<b>169 543 307</b>	2.509

d (mm)	D (mm)	L (mm)	L1 (mm)	L2 (mm)	L3 (mm)	L4 (mm)	L5 (mm)	L6 (mm)	H (mm)	H1 (mm)	H2 (mm)	M (mm)	e (mm)	closest inch (inch)
20	50	210	77	73	36	25	32	45	57	28	8	6	2.3	1/2
25	58	237	97	86	43	25	39	58	67	32	8	6	2.3	3/4
32	68	251	97	99	50	25	39	58	73	36	8	6	2.9	1
40	84	283	128	120	60	45	54	74	90	45	9	8	3.7	1 1/4
50	97	319	128	137	69	45	54	74	97	51	9	8	4.6	1 1/2
63	124	399	152	179	89	45	66	87	116	65	9	8	5.8	2



**3-Way ball valve type 543 ABS**  
**Horizontal/T-port**  
**With solvent cement sockets BS**

**Model:**

- For easy installation and removal (valve end and union nut are compatible with type 546)
- Ball seals PTFE
- Pneumatic or electric actuator available separately
- Angle of operation 360° without turn limiter
- Turn limiter 90° enclosed, in different positions usable as a clip-on ring
- Integrated stainless steel mounting inserts
- Delivery status A-B-C opened, see flow scheme

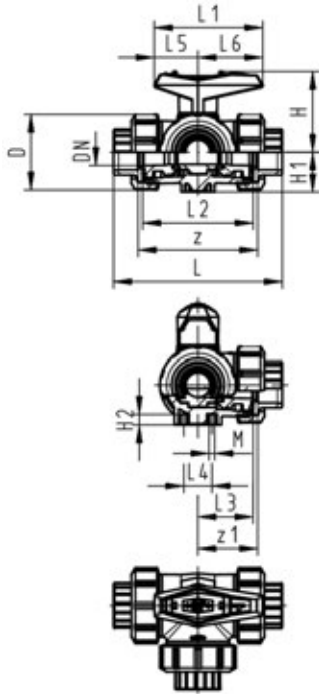

Size (inch)	DN (mm)	PN (bar)	kv-value ( $\Delta p=1$ bar) (l/min)	EPDM Code	Weight (kg)
3/8	10	10	140	<b>169 543 261</b>	0.186
1/2	15	10	200	<b>169 543 262</b>	0.191
3/4	20	10	470	<b>169 543 263</b>	0.274
1	25	10	793	<b>169 543 264</b>	0.415
1 1/4	32	10	1290	<b>169 543 265</b>	0.708
1 1/2	40	10	1910	<b>169 543 266</b>	1.045
2	50	10	3100	<b>169 543 267</b>	2.030

Size (inch)	D (mm)	H (mm)	H1 (mm)	H2 (mm)	L (mm)	L1 (mm)	L2 (mm)	L3 (mm)	L4 (mm)	L5 (mm)	L6 (mm)	M (mm)	z (mm)	z1 (mm)
3/8	50	57	28	8	109	77	73	36	25	32	45	6	77	38
1/2	50	57	28	8	112	77	73	36	25	32	45	6	77	38
3/4	58	67	32	8	131	97	86	43	25	39	58	6	90	45
1	68	73	36	8	151	97	99	50	25	39	58	6	103	52
1 1/4	84	90	45	9	181	128	120	60	45	54	74	8	124	62
1 1/2	97	97	51	9	205	128	137	69	45	54	74	8	145	73
2	124	116	65	9	261	152	179	89	45	66	87	8	189	94

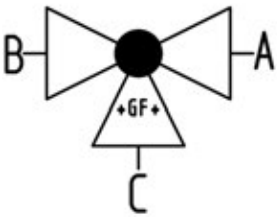

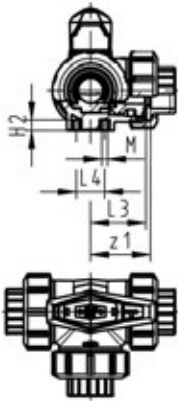
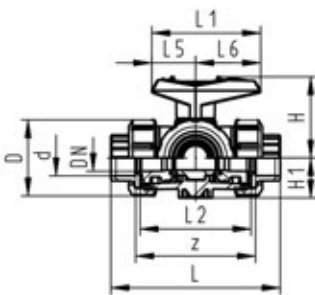
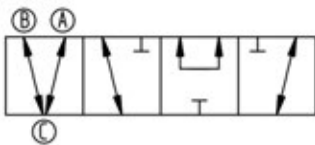
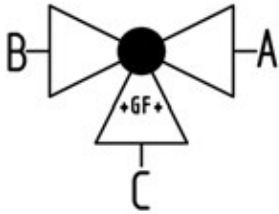

**3-Way ball valve type 543 ABS**  
**Horizontal/T-port**  
**With solvent cement sockets metric**

**Model:**

- For easy installation and removal (valve end and union nut are compatible with type 546)
- Ball seals PTFE
- Pneumatic or electric actuator available separately
- Angle of operation 360° without turn limiter
- Turn limiter 90° enclosed, in different positions usable as a clip-on ring
- Integrated stainless steel mounting inserts
- Delivery status A-B-C opened, see flow scheme

d (mm)	DN (mm)	PN (bar)	kv-value ( $\Delta p=1$ bar) (l/min)	EPDM Code	Weight (kg)
16	10	10	140	<b>169 543 201</b>	0.186
20	15	10	200	<b>169 543 202</b>	0.178
25	20	10	470	<b>169 543 203</b>	0.263
32	25	10	793	<b>169 543 204</b>	0.403
40	32	10	1290	<b>169 543 205</b>	0.699
50	40	10	1910	<b>169 543 206</b>	1.046
63	50	10	3100	<b>169 543 207</b>	2.030

d (mm)	D (mm)	H (mm)	H1 (mm)	H2 (mm)	L (mm)	L1 (mm)	L2 (mm)	L3 (mm)	L4 (mm)	L5 (mm)	L6 (mm)	M (mm)	z (mm)	z1 (mm)
16	50	57	28	8	109	77	73	36	25	32	45	6	81	40
20	50	57	28	8	112	77	73	36	25	32	45	6	81	40
25	58	67	32	8	131	97	86	43	25	39	58	6	94	47
32	68	73	36	8	151	97	99	50	25	39	58	6	107	54
40	84	90	45	9	181	128	120	60	45	54	74	8	130	65
50	97	97	51	9	205	128	137	69	45	54	74	8	143	72
63	124	116	65	9	261	152	179	89	45	66	87	8	185	92



**3-Way ball valve type 543 ABS**  
**Horizontal/T-port**  
**With threaded sockets Rp**

**Model:**

- For easy installation and removal (valve end and union nut are compatible with type 546)
- Ball seals PTFE
- Pneumatic or electric actuator available separately
- Angle of operation 360° without turn limiter
- Turn limiter 90° enclosed, in different positions usable as a clip-on ring
- Integrated stainless steel mounting inserts
- Delivery status A-B-C opened, see flow scheme

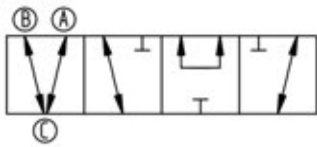
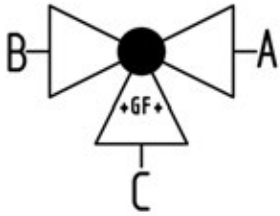

Rp (inch)	DN (mm)	PN (bar)	kv-value ( $\Delta p=1$ bar) (l/min)	EPDM Code	Weight (kg)
3/8	10	10	140	<b>169 543 241</b>	0.186
1/2	15	10	200	<b>169 543 242</b>	0.191
3/4	20	10	470	<b>169 543 243</b>	0.274
1	25	10	793	<b>169 543 244</b>	0.415
1 1/4	32	10	1290	<b>169 543 245</b>	0.708
1 1/2	40	10	1910	<b>169 543 246</b>	1.045
2	50	10	3100	<b>169 543 247</b>	2.030

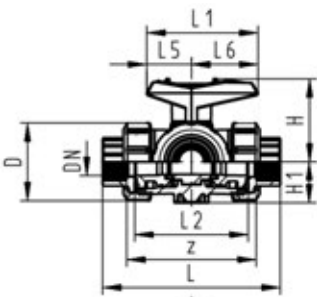

Rp (inch)	D (mm)	H (mm)	H1 (mm)	H2 (mm)	L (mm)	L1 (mm)	L2 (mm)	L3 (mm)	L4 (mm)	L5 (mm)	L6 (mm)	M (mm)	z (mm)	z1 (mm)
3/8	50	57	28	8	113	77	73	36	25	32	45	6	87	43
1/2	50	57	28	8	117	77	73	36	25	32	45	6	85	42
3/4	58	67	32	8	135	97	86	43	25	39	58	6	100	50
1	68	73	36	8	155	97	99	50	25	39	58	6	113	57
1 1/4	84	90	45	9	179	128	120	60	45	54	74	8	134	67
1 1/2	97	97	51	9	201	128	137	69	45	54	74	8	155	78
2	124	116	65	9	255	152	179	89	45	66	87	8	199	99

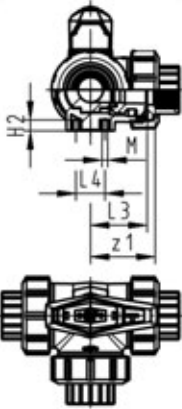



**3-Way ball valve type 543 ABS**  
**Horizontal/T-port**  
**With butt fusion spigots long**  
**PE100 SDR11 metric**

**Model:**

- Material: ABS/PE
- For easy installation and removal (valve end and union nut are compatible with type 546)
- Ball seals PTFE
- Pneumatic or electric actuator available separately
- Angle of operation 360° without turn limiter
- Turn limiter 90° enclosed, in different positions usable as a clip-on ring
- Integrated stainless steel mounting inserts
- Delivery status A-B-C opened, see flow scheme

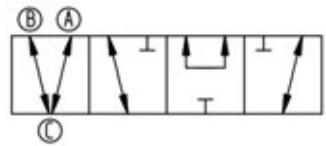
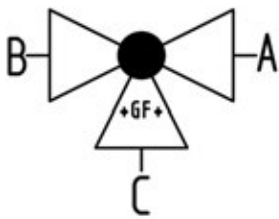
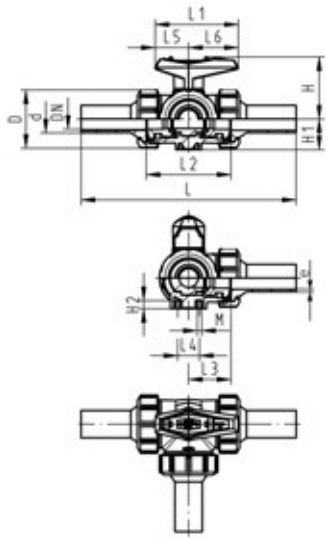

d (mm)	DN (mm)	PN (bar)	kv-value ( $\Delta p=1$ bar) (l/min)	EPDM Code	Weight (kg)
20	15	10	200	<b>169 543 322</b>	0.203
25	20	10	470	<b>169 543 323</b>	0.296
32	25	10	793	<b>169 543 324</b>	0.450
40	32	10	1290	<b>169 543 325</b>	0.762
50	40	10	1910	<b>169 543 326</b>	1.161
63	50	10	3100	<b>169 543 327</b>	2.509

d (mm)	D (mm)	L (mm)	L1 (mm)	L2 (mm)	L3 (mm)	L4 (mm)	L5 (mm)	L6 (mm)	H (mm)	H1 (mm)	H2 (mm)	M (mm)	e (mm)
20	50	210	77	73	36	25	32	45	57	28	8	6	2.3
25	58	237	97	86	43	25	39	58	67	32	8	6	2.3
32	68	251	97	99	50	25	39	58	73	36	8	6	2.9
40	84	283	128	120	60	45	54	74	90	45	9	8	3.7
50	97	319	128	137	69	45	54	74	97	51	9	8	4.6
63	124	399	152	179	89	45	66	87	116	65	9	8	5.8





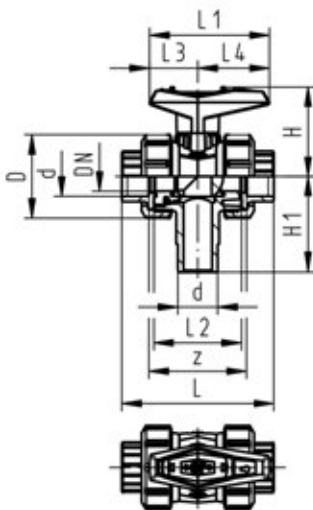
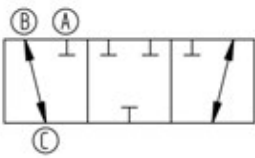
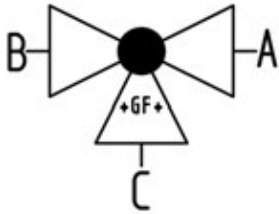

**3-Way ball valve type 543 ABS**  
**Vertical/L-port**  
**With solvent cement sockets metric**

**Model:**

- Vertical inlet solvent cement spigot metric
- Easy installation and removal using union on third outlet
- Ball seals PTFE
- Electric actuator available separately
- Angle of operation 360° without turn limiter
- Delivery status B-C opened, see flow scheme

**Mode of action:**

- For interconnection of two inputs

d (mm)	DN (mm)	PN (bar)	kv-value ( $\Delta p=1$ bar) (l/min)	EPDM Code	Weight (kg)
16	10	10	49	<b>169 543 401</b>	0.124
20	15	10	77	<b>169 543 402</b>	0.123
25	20	10	146	<b>169 543 403</b>	0.194
32	25	10	260	<b>169 543 404</b>	0.284
40	32	10	437	<b>169 543 405</b>	0.475
50	40	10	667	<b>169 543 406</b>	0.676
63	50	10	1293	<b>169 543 407</b>	1.234

d (mm)	D (mm)	H (mm)	H1 (mm)	L (mm)	L1 (mm)	L2 (mm)	L3 (mm)	L4 (mm)	z (mm)
16	50	57	62	92	77	56	32	45	64
20	50	57	62	95	77	56	32	45	64
25	58	67	72	111	97	66	39	58	74
32	68	73	77	123	97	71	39	58	79
40	84	90	87	146	128	85	54	74	95
50	97	97	97	157	128	89	54	74	95
63	124	116	112	183	152	101	66	87	107



**3-Way ball valve type 543 ABS**  
**Vertical/L-port**  
**With threaded sockets Rp**

**Model:**

- Vertical inlet solvent cement spigot metric
- Easy installation and removal using union on third outlet
- Ball seals PTFE
- Electric actuator available separately
- Angle of operation 360° without turn limiter
- Delivery status B-C opened, see flow scheme

**Mode of action:**

- For interconnection of two inputs

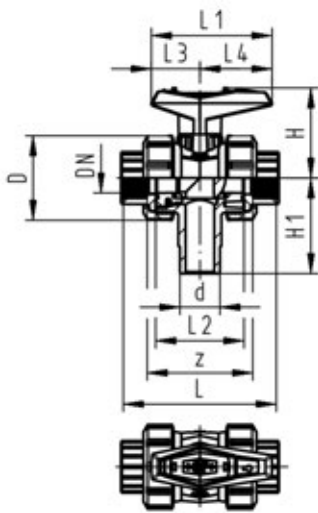
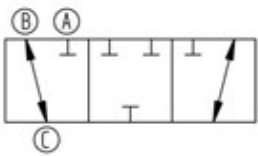
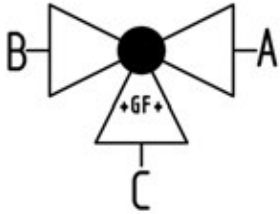

Rp (inch)	DN (mm)	PN (bar)	kv-value ( $\Delta p=1$ bar) (L/min)	EPDM Code	Weight (kg)
3/8	10	10	49	<b>169 543 421</b>	0.124
1/2	15	10	77	<b>169 543 422</b>	0.127
3/4	20	10	146	<b>169 543 423</b>	0.194
1	25	10	260	<b>169 543 424</b>	0.284
1 1/4	32	10	437	<b>169 543 425</b>	0.475
1 1/2	40	10	667	<b>169 543 426</b>	0.676
2	50	10	1293	<b>169 543 427</b>	1.234

Rp (inch)	D (mm)	H (mm)	H1 (mm)	L (mm)	L1 (mm)	L2 (mm)	L3 (mm)	L4 (mm)	z (mm)
3/8	50	57	62	96	77	56	32	45	69
1/2	50	57	62	99	77	56	32	45	67
3/4	58	67	72	115	97	66	39	58	78
1	68	73	77	127	97	71	39	58	85
1 1/4	84	90	87	144	128	85	54	74	100
1 1/2	97	97	97	153	128	89	54	74	106
2	124	116	112	177	152	101	66	87	121

# Connecting parts type 546 and 543



**Valve end 546 and 543 ABS (G21)**  
With solvent cement socket Inch BS

Size (inch)	PN (bar)	Code	Weight (kg)	D (mm)	D1 (mm)	L (mm)	L1 (mm)	z (mm)
3/8	10	<b>169 480 800</b>	0.007	38	23	18	4	2
1/2	10	<b>169 480 801</b>	0.007	38	27	20	4	2
3/4	10	<b>169 480 802</b>	0.011	44	33	23	5	2
1	10	<b>169 480 803</b>	0.017	53	41	26	5	2
1 1/4	10	<b>169 480 804</b>	0.026	65	51	31	5	2
1 1/2	10	<b>169 480 805</b>	0.052	77	62	34	6	4
2	10	<b>169 480 806</b>	0.100	99	77	41	7	5
2 1/2	10	<b>169 480 782</b>	0.175	125	92	49	9	4
3	10	<b>169 480 808</b>	0.300	150	110	57	10	6
4	10	<b>169 480 809</b>	0.446	180	134	69	11	5



**Valve end 546 and 543 ABS (G20)**  
With solvent cement socket metric

d (mm)	PN (bar)	Code	Weight (kg)	D1 (mm)	z (mm)	L (mm)	D (mm)	L1 (mm)
16	10	<b>169 480 775</b>	0.006	23	4	18	38	4
20	10	<b>169 480 776</b>	0.008	27	4	20	38	4
25	10	<b>169 480 777</b>	0.012	33	4	22	44	5
32	10	<b>169 480 778</b>	0.019	41	4	26	53	5
40	10	<b>169 480 779</b>	0.031	51	5	31	65	5
50	10	<b>169 480 780</b>	0.047	62	3	34	77	6
63	10	<b>169 480 781</b>	0.086	77	3	41	99	7
75	10	<b>169 480 782</b>	0.175	92	4	49	125	9
90	10	<b>169 480 783</b>	0.292	110	5	57	150	10
110	10	<b>169 480 784</b>	0.495	134	5	69	180	11



**Valve end 546 and 543 ABS (G22)**  
With threaded socket Rp

**Model:**

- Connection to plastic threads only
- Do not use thread sealing pastes that are harmful to ABS

Rp (inch)	PN (bar)	Code	Weight (kg)	D (mm)	D1 (mm)	L (mm)	L1 (mm)	z (mm)
3/8	10	<b>169 480 786</b>	0.008	38	24	20	4	7
1/2	10	<b>169 480 787</b>	0.009	38	28	22	4	6
3/4	10	<b>169 480 788</b>	0.014	44	34	25	5	7
1	10	<b>169 480 789</b>	0.023	53	42	28	5	7
1 1/4	10	<b>169 480 790</b>	0.034	65	52	30	5	7
1 1/2	10	<b>169 480 791</b>	0.059	77	63	32	6	9
2	10	<b>169 480 792</b>	0.109	99	78	38	7	10



**Valve end 546 and 543 ABS (G23)**  
**With threaded socket Rp reinforced**

**Model:**

- Connection to plastic or metal threads
- Reinforcing ring stainless (A2)
- Do not use thread sealing pastes that are harmful to ABS

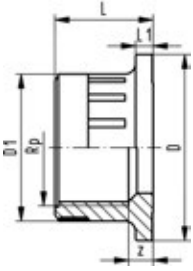

Rp (inch)	PN (bar)	Code	Weight (kg)	D (mm)	D1 (mm)	L (mm)	L1 (mm)	z (mm)
3/8	16	<b>169 480 925</b>	0.008	38	24	20	4	7
1/2	16	<b>169 480 926</b>	0.010	38	28	22	4	6
3/4	16	<b>169 480 927</b>	0.014	44	34	25	5	7
1	16	<b>169 480 928</b>	0.023	53	42	28	5	7
1 1/4	16	<b>169 480 929</b>	0.035	65	52	30	5	7
1 1/2	16	<b>169 480 930</b>	0.077	77	63	32	6	9
2	16	<b>169 480 931</b>	0.130	99	78	38	7	10



DN10/15 - 50



**Multifunctional handle 546 red (K11)**  
**With ratchet settings lockable**

**Note:**

To retrofit the ball valve 546 with the multifunctional handle a multifunction module is necessary in the dimensions DN65-100

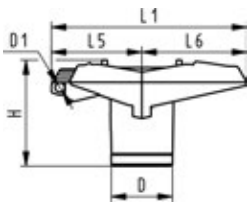

d-d (mm)	DN-DN (mm)	Code	Weight (kg)	D (mm)	D1 (mm)	H (mm)	L1 (mm)	L5 (mm)	L6 (mm)
16 - 20	10 - 15	<b>167 484 100</b>	0.026	26	5	53	87	42	45
-- 25	-- 20	<b>167 484 101</b>	0.045	34	5	59	108	50	58
-- 32	-- 25	<b>167 484 102</b>	0.047	34	5	59	108	50	58
-- 40	-- 32	<b>167 484 103</b>	0.091	40	5	69	140	66	75
-- 50	-- 40	<b>167 484 104</b>	0.080	40	5	69	140	66	75
-- 63	-- 50	<b>167 484 105</b>	0.124	44	5	80	165	78	87
-- 75	-- 65	<b>161 486 689</b>	0.468	115	12	105	270	64	206
-- 90	-- 80	<b>161 486 690</b>	0.467	115	12	105	270	64	206
110 - 140	100 - 125	<b>161 486 691</b>	0.543	115	12	107	320	64	256

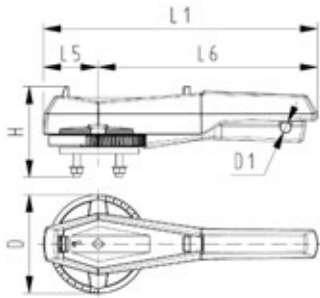

## Handle extension 546 PVC-U inch BS/ASTM

### Model:

- For Ball Valve Type 546

Includes upper and lower extension adapter, does not include 3/4" pipe



Inch (inch)	DN-DN (mm)	Code	Weight (kg)	H (mm)	H1 (mm)	H2 (mm)	H3 (mm)	D (mm)
3/8-1/2	10 - 15	<b>161 486 443</b>	0.032	41	52	29	36	26
3/4-1	20 - 25	<b>161 486 444</b>	0.030	50	62	32	39	36
1 1/4-1 1/2	32 - 40	<b>161 486 445</b>	0.047	65	76	34	44	40
2	50	<b>161 486 446</b>	0.058	84	87	37	48	44

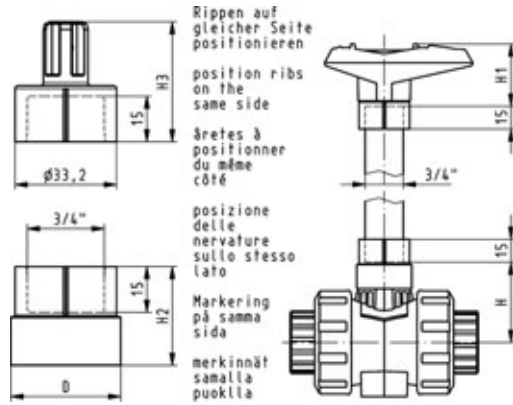



### Handle extension 546 and 543 PVC-U metric

**Model:**

- For ball valve type 546 and 543
- Composed of adapter sockets for handle connection and stem connection
- PVC-U pipe in suitable length has to be obtained on site

d-d (mm)	DN-DN (mm)	Code	Weight (kg)	H (mm)	H1 (mm)	H2 (mm)	H3 (mm)	D (mm)
16 - 20	10 - 15	<b>161 486 435</b>	0.030	41	52	29	36	26
25 - 32	20 - 25	<b>161 486 436</b>	0.029	50	62	32	39	36
40 - 50	32 - 40	<b>161 486 437</b>	0.045	65	76	34	44	40
-- 63	-- 50	<b>161 486 438</b>	0.059	84	87	37	48	44

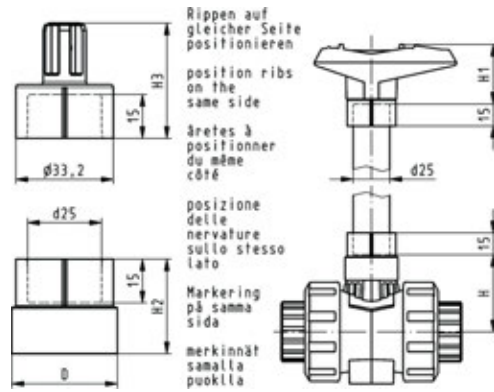

### Handle extension for ball valve type 546 PVC-U DN65 - DN100

**Model:**

- Height variable
- Multiple use in succession possible

d-d (mm)	DN-DN (mm)	Code	Weight (kg)	H (mm)	H1 (mm)	D (mm)
75 - 90	65 - 80	<b>161 490 920</b>	0.323	143	100	58
-- 110	-- 100	<b>161 490 921</b>	0.413	143	100	64

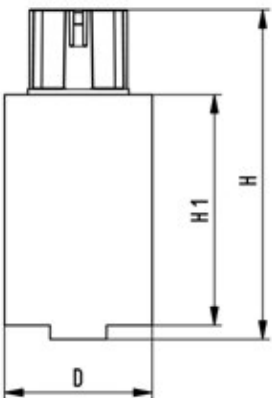



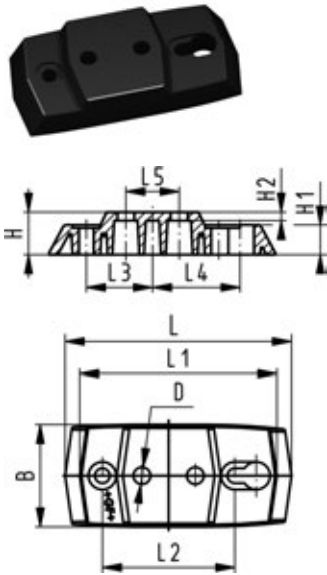

### Mounting plate 546 and 543 PP-GF (L02)

- 2 mounting screws inclusive

d-d (mm)	Inch (inch)	DN-DN (mm)	Code	Weight (kg)
16 - 32	3/8 - 1	10 - 25	<b>167 484 110</b>	0.054
40 - 63	1 1/4 - 2	32 - 50	<b>167 484 111</b>	0.066

d-d (mm)	Inch (inch)	B (mm)	D (mm)	H (mm)	H1 (mm)	H2 (mm)	L (mm)	L1 (mm)	L2 (mm)	L3 (mm)	L4 (mm)	L5 (mm)
16 - 32	3/8 - 1	48	8	20	14	4	106	92	62	31	41	25
40 - 63	1 1/4 - 2	54	9	20	14	4	149	134	104	52	62	45

## Multifunctional modules



DN10/15 - 50

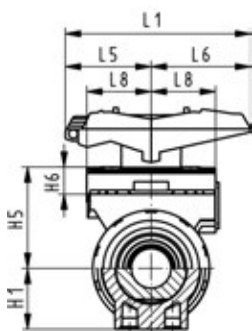
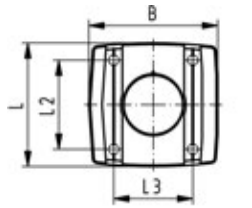

### Multifunctional module (I02) PP-GF Module empty

#### Model:

- Accessory to ball valve type 546
- Multifunctional module acts as an intermediate element for actuators
- For operation with handle, multifunctional handle has to be ordered separately.
- Including screws to mount the module and stainless steel coupling piece (V2A) for dimension DN65-100
- The multifunctional module from d75 - d110 has a master gauge F07 according to EN ISO 5211.

d-d (mm)	Inch (inch)	DN-DN (mm)	Code	Weight (kg)
16 - 20	3/8 - 1/2	10 - 15	<b>167 482 680</b>	0.069
25 - 32	3/4 - 1	20 - 25	<b>167 482 681</b>	0.149
40 - 50	1 1/4 - 1 1/2	32 - 40	<b>167 482 682</b>	0.168
63	2	50	<b>167 482 683</b>	0.209
75 - 90	2 1/2 - 3	65 - 80	<b>167 482 684</b>	0.379
110	4	100	<b>167 482 685</b>	0.607

d-d (mm)	B (mm)	H1 (mm)	H5 (mm)	H6 (mm)	L (mm)	L1 (mm)	L2 (mm)	L3 (mm)	L5 (mm)	L6 (mm)	L8 (mm)
16 - 20	67	27	50	17	72	87	54	40	42	45	34
25 - 32	75	30	53	16	72	108	52	46	50	58	38
40 - 50	81	44	72	16	80	140	60	50	66	75	41
63	91	64	94	19	93	165	68	65	78	87	46
75 - 90	90	85	157	23	85	270			64	206	
110	106	123	175	23	97	320			64	256	



**Multifunctional module (I03) PP-GF**  
**With mechanical limit switches AgNi**

**Model:**

- Accessory to ball valve type 546
- Multifunctional module acts as an intermediate element for actuators
- For operation with handle, multifunctional handle has to be ordered separately.
- Including plug 3P+E / protection: IP65
- Including screws to mount the module and stainless steel coupling piece (V2A) for dimension DN65-100
- Switch type Crouzet 8992803

d-d (mm)	Inch (inch)	DN-DN (mm)	Code	Weight (kg)	H1 (mm)	H5 (mm)	L1 (mm)	L5 (mm)	L6 (mm)	L8 (mm)	L9 (mm)
16 - 20	3/8 - 1/2	10 - 15	<b>167 482 626</b>	0.104	27	50	87	42	45	34	73
25 - 32	3/4 - 1	20 - 25	<b>167 482 627</b>	0.118	30	53	108	50	58	38	77
40 - 50	1 1/4 - 1 1/2	32 - 40	<b>167 482 628</b>	0.140	44	72	140	66	75	41	80
-- 63	2	-- 50	<b>167 482 629</b>	0.257	64	94	165	78	87	46	85
75 - 90	2 1/2 - 3	65 - 80	<b>167 482 630</b>	0.478	85	157	270	64	206		
-- 110	4	-- 100	<b>167 482 631</b>	0.480	123	175	320	64	256		



**Multifunctional module (I04) PP-GF**  
**With mechanical limit switches Au**

**Model:**

- Accessory to ball valve type 546
- Multifunctional module acts as an intermediate element for actuators
- For operation with handle, multifunctional handle has to be ordered separately.
- Including plug 3P+E / protection: IP65
- Including screws to mount the module and stainless steel coupling piece (V2A) for dimension DN65-100
- Switch type Crouzet 8992803

d-d (mm)	Inch (inch)	DN-DN (mm)	Code	Weight (kg)	H1 (mm)	H5 (mm)	L1 (mm)	L5 (mm)	L6 (mm)	L8 (mm)	L9 (mm)
16 - 20	3/8 - 1/2	10 - 15	<b>167 482 635</b>	0.103	27	50	87	42	45	34	73
25 - 32	3/4 - 1	20 - 25	<b>167 482 636</b>	0.120	30	53	108	50	58	38	77
40 - 50	1 1/4 - 1 1/2	32 - 40	<b>167 482 637</b>	0.138	44	72	140	66	75	41	80
-- 63	2	-- 50	<b>167 482 638</b>	0.175	64	94	165	78	87	46	85
75 - 90	2 1/2 - 3	65 - 80	<b>167 482 639</b>	0.460	85	157	270	64	206		
-- 110	4	-- 100	<b>167 482 640</b>	0.480	123	175	320	64	256		



**Multifunctional module (I05) PP-GF**  
**With inductive limit switches Namur**

**Model:**

- Accessory to ball valve type 546
- Multifunctional module acts as an intermediate element for actuators
- For operation with handle, multifunctional handle has to be ordered separately.
- Including plug 3P+E / protection: IP65
- Including screws to mount the module and stainless steel coupling piece (V2A) for dimension DN65-100

d-d (mm)	Inch (inch)	DN-DN (mm)	Code	Weight (kg)	H1 (mm)	H5 (mm)	L1 (mm)	L5 (mm)	L6 (mm)	L8 (mm)	L9 (mm)
16 - 20	¾ - ½	10 - 15	<b>167 482 671</b>	0.097	27	50	87	42	45	34	73
25 - 32	¾ - 1	20 - 25	<b>167 482 672</b>	0.107	30	53	108	50	58	38	77
40 - 50	1 ¼ - 1 ½	32 - 40	<b>167 482 673</b>	0.135	44	72	140	66	75	41	80
-- 63	2	-- 50	<b>167 482 674</b>	0.257	64	94	165	78	87	46	85
75 - 90	2 ½ - 3	65 - 80	<b>167 482 675</b>	0.460	85	157	270	64	206		
-- 110	4	-- 100	<b>167 482 676</b>	0.480	123	175	320	64	256		



**Multifunctional module (I06) PP-GF**  
**With inductive limit switches PNP**

**Model:**

- Accessory to ball valve type 546
- Multifunctional module acts as an intermediate element for actuators
- For operation with handle, multifunctional handle has to be ordered separately.
- Including plug 3P+E / protection: IP65
- Including screws to mount the module and stainless steel coupling piece (V2A) for dimension DN65-100
- Switch type Pepperl+Fuchs NBB1.5-F79-E2

d-d (mm)	Inch (inch)	DN-DN (mm)	Code	Weight (kg)	H1 (mm)	H5 (mm)	L1 (mm)	L5 (mm)	L6 (mm)	L8 (mm)	L9 (mm)
16 - 20	¾ - ½	10 - 15	<b>167 482 662</b>	0.182	27	50	87	42	45	34	73
25 - 32	¾ - 1	20 - 25	<b>167 482 663</b>	0.197	30	53	108	50	58	38	77
40 - 50	1 ¼ - 1 ½	32 - 40	<b>167 482 664</b>	0.215	44	72	140	66	75	41	80
-- 63	2	-- 50	<b>167 482 665</b>	0.175	64	94	165	78	87	46	85
75 - 90	2 ½ - 3	65 - 80	<b>167 482 666</b>	0.460	85	157	270	64	206		
-- 110	4	-- 100	<b>167 482 667</b>	0.480	123	175	320	64	256		



DN10/15 - 50

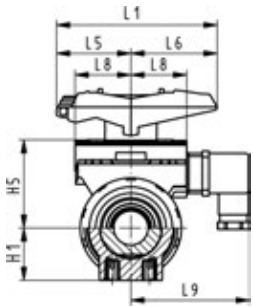
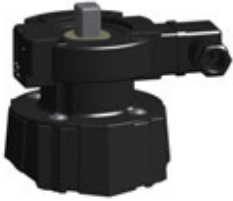

**Multifunctional module (I07) PP-GF**  
**With inductive limit switches NPN**

**Model:**

- Accessory to ball valve type 546
- Multifunctional module acts as an intermediate element for actuators
- For operation with handle, multifunctional handle has to be ordered separately.
- Including plug 3P+E / protection: IP65
- Including screws to mount the module and stainless steel coupling piece (V2A) for dimension DN65-100
- Switch type Pepperl+Fuchs NBB1.5-F79-E1

d-d (mm)	Inch (inch)	DN-DN (mm)	Code	Weight (kg)	H1 (mm)	H5 (mm)	L1 (mm)	L5 (mm)	L6 (mm)	L8 (mm)	L9 (mm)
16 - 20	3/8 - 1/2	10 - 15	<b>167 482 653</b>	0.110	27	50	87	42	45	34	73
25 - 32	3/4 - 1	20 - 25	<b>167 482 654</b>	0.120	30	53	108	50	58	38	77
40 - 50	1 1/4 - 1 1/2	32 - 40	<b>167 482 655</b>	0.135	44	72	140	66	75	41	80
-- 63	2	-- 50	<b>167 482 656</b>	0.175	64	94	165	78	87	46	85
75 - 90	2 1/2 - 3	65 - 80	<b>167 482 657</b>	0.460	85	157	270	64	206		
-- 110	4	-- 100	<b>167 482 658</b>	0.480	123	175	320	64	256		

# Diaphragm Valves

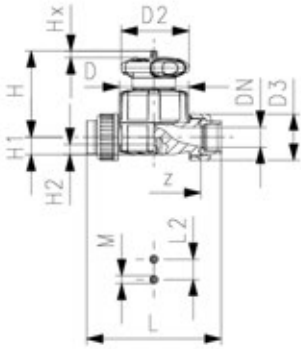

## Diaphragm valve type 514 ABS With solvent cement sockets BS

### Model:

- Double flow rate compared to predecessor
- One housing nut replaces four screws
- Handwheel with built-in locking mechanism
- For easy installation and removal
- Short overall length

### Option:

- Individual configuration of the valve (see diagram)
- Self adjusting multifunctional module with integrated limit switches

Size (inch)	DN (mm)	PN (bar)	kv-value ( $\Delta p=1$ bar) (L/min)	EPDM Code	PTFE/EPDM Code	Weight (kg)
½	15	10	125	169 514 512	169 514 532	0.364
¾	20	10	271	169 514 513	169 514 533	0.476
1	25	10	481	169 514 514	169 514 534	1.079
1 ¼	32	10	759	169 514 515	169 514 535	1.317
1 ½	40	10	1263	169 514 516	169 514 536	2.350
2	50	10	1728	169 514 517	169 514 537	3.063

Size (inch)	D (mm)	D2 (mm)	D3 (mm)	H (mm)	H1 (mm)	H2 (mm)	L (mm)	L2 (mm)	M	z (mm)	Lift = Hx (mm)
½	65	65	43	73	14	12	128	25	M6	96	7
¾	80	65	51	81	18	12	152	25	M6	114	10
1	88	87	58	107	22	12	166	25	M6	122	13
1 ¼	101	87	72	115	26	15	192	45	M8	140	15
1 ½	117	135	83	148	32	15	222	45	M8	160	19
2	144	135	100	166	39	15	266	45	M8	190	25

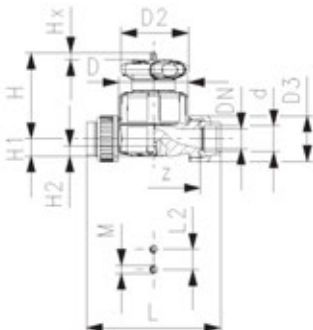

## Diaphragm valve type 514 ABS With solvent cement sockets metric

### Model:

- Double flow rate compared to predecessor
- One housing nut replaces four screws
- Handwheel with built-in locking mechanism
- For easy installation and removal
- Short overall length

### Option:

- Individual configuration of the valve (see diagram)
- Self adjusting multifunctional module with integrated limit switches

d (mm)	DN (mm)	PN (bar)	kv-value ( $\Delta p=1$ bar) (L/min)	EPDM Code	PTFE/EPDM Code	Weight (kg)
20	15	10	125	169 514 012	169 514 032	0.365
25	20	10	271	169 514 013	169 514 033	0.479
32	25	10	481	169 514 014	169 514 034	1.081
40	32	10	759	169 514 015	169 514 035	1.357
50	40	10	1263	169 514 016	169 514 036	2.374
63	50	10	1728	169 514 017	169 514 037	3.111

table continued on the next page

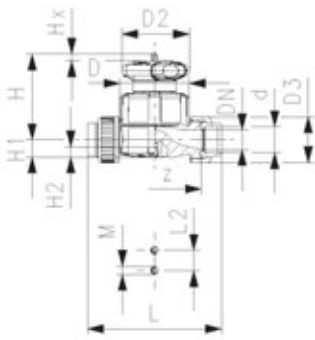

d (mm)	D (mm)	D2 (mm)	D3 (mm)	H (mm)	H1 (mm)	H2 (mm)	L (mm)	L2 (mm)	M	z (mm)	Lift = Hx (mm)	closest inch (inch)
20	65	65	43	73	14	12	128	25	M6	96	7	½
25	80	65	51	81	18	12	152	25	M6	114	10	¾
32	88	87	58	107	22	12	166	25	M6	122	13	1
40	101	87	72	115	26	15	192	45	M8	140	15	1 ¼
50	117	135	83	148	32	15	222	45	M8	160	19	1 ½
63	144	135	100	166	39	15	266	45	M8	190	25	2



### Diaphragm valve type 515 ABS With solvent cement spigots metric

#### Model:

- Double flow rate compared to predecessor
- One housing nut replaces four screws
- Handwheel with built-in locking mechanism
- Overall length EN 558

#### Option:

- Individual configuration of the valve (see diagram)
- Self adjusting multifunctional module with integrated limit switches

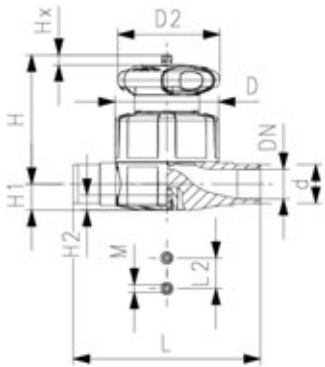

d (mm)	DN (mm)	PN (bar)	kv-value ( $\Delta p=1$ bar) (L/min)	EPDM Code	PTFE/EPDM Code	Weight (kg)
20	15	10	125	169 515 012	169 515 032	0.318
25	20	10	271	169 515 013	169 515 033	0.412
32	25	10	481	169 515 014	169 515 034	0.992
40	32	10	759	169 515 015	169 515 035	1.164
50	40	10	1263	169 515 016	169 515 036	2.141
63	50	10	1728	169 515 017	169 515 037	2.726

d (mm)	D (mm)	D2 (mm)	H (mm)	H1 (mm)	H2 (mm)	L (mm)	L2 (mm)	M	Lift = Hx (mm)	closest inch (inch)
20	65	65	73	14	12	124	25	M6	7	½
25	80	65	81	18	12	144	25	M6	10	¾
32	88	87	107	22	12	154	25	M6	13	1
40	101	87	115	26	15	174	45	M8	15	1 ¼
50	117	135	148	32	15	194	45	M8	19	1 ½
63	144	135	166	39	15	224	45	M8	25	2



**Diaphragm valve type 317 ABS**  
**With flanges metric**

**Model:**

- Flat sealing faces
- DN 80-150 with fixed flange
- Overall length according to EN 558
- Other dimensions available on request
- Minimum temperature: - 30°C

**Option:**

- Handwheel lockable DN15-65 (basic version not lockable)

**\* DN80 and DN150 fixed flanges metric and Inch ANSI B16.5**

	d (mm)	DN (mm)	PN (bar)	kv-value ( $\Delta p=1$ bar) (l/min)	EPDM Code	Weight (kg)	PTFE/EPDM Code
	75	65	10	992	<b>169 317 423</b>	4.731	<b>169 317 038</b>
*	90	80	10	1700	<b>169 317 024</b>	8.350	<b>169 317 039</b>
	110	100	10	2700	<b>169 317 025</b>	11.669	<b>169 317 040</b>

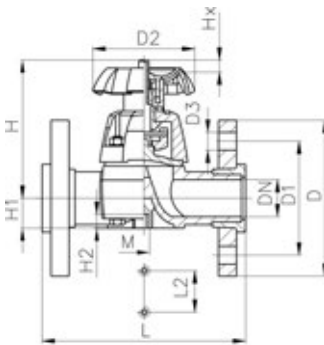

DN 15-65

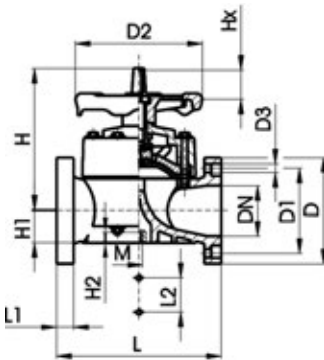

DN 80-100

	d (mm)	D (mm)	D1 (mm)	D2 (mm)	D3 (mm)	H (mm)	H1 (mm)	H2 (mm)	L (mm)	L1 (mm)	L2 (mm)	M	AL	Lift = Hx (mm)
	75	185	145	152	18	201	46	15	290		70	M8	4	30
*	90	200	160	270	18	265	57	23	310	35	120	M12	8	40
	110	225	180	270	18	304	69	23	350	35	120	M12	8	50



# Butterfly Valves

## Butterfly Valves Type 567



### Butterfly valve type 567 ABS Bare shaft

#### Model:

- Overall length according to EN 558, ISO 5752
- Connecting dimension: ISO 7005 PN 10, EN 1092 PN 10, DIN 2501 PN 10, ANSI/ASME B 16.5 Class 150, BS 1560: 1989, BS 4504, JIS B 2220
- Interface F07 according to DIN/ISO 5211

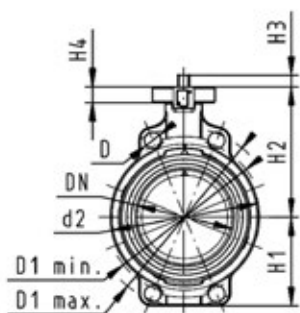

d (mm)	DN (mm)	PN (bar)	kv-value ( $\Delta p=1$ bar) (l/min)	EPDM Code	Weight (kg)
63	50	10	1470	<b>169 567 802</b>	0.763
75	65	10	2200	<b>169 567 803</b>	0.859
90	80	10	3000	<b>169 567 804</b>	0.999
110	100	10	6500	<b>169 567 805</b>	1.535
140	125	10	11500	<b>169 567 806</b>	2.018
160	150	10	16600	<b>169 567 807</b>	2.858
225	200	10	39600	<b>169 567 808</b>	4.129
280	250	10	51000	<b>169 567 809</b>	11.600
315	300	10	73000	<b>169 567 810</b>	16.000

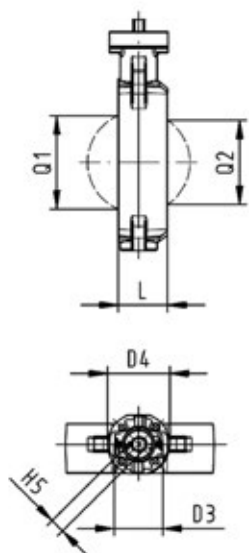

d (mm)	d2 (mm)	D (mm)	D1 min. (mm)	D1 max. (mm)	D3 (mm)	D4 (mm)	H (mm)	H1 (mm)	H2 (mm)	H3 (mm)	H4 (mm)	H5 (mm)	L (mm)	Q1 (mm)
63	104	19	120	125	70	90	238	77	134	27	23	11	45	40
75	115	19	140	145	70	90	250	83	140	27	23	11	46	54
90	131	19	150	160	70	90	262	89	146	27	23	11	49	67
110	161	19	175	191	70	90	287	104	167	16	23	14	56	88
140	187	23	210	216	70	90	314	117	181	16	23	14	64	113
160	215	24	241	241	70	90	338	130	189	19	23	17	72	139
225	267	23	290	295	70	90	387	158	210	19	23	17	73	178
280	329	25	353	362	102	125	509	205	264	40	23	22	113	210
315	379	25	400	432	102	125	553	228	285	40	23	22	113	256

d (mm)	Q2 (mm)
63	
75	35
90	50
110	74
140	97
160	123
225	169
280	207
315	253



### Butterfly valve type 567 ABS Hand lever with ratchet settings

**Model:**

- Overall length according to EN 558, ISO 5752
- Connecting dimension: ISO 7005 PN 10, EN 1092 PN 10, DIN 2501 PN 10, ANSI/ASME B 16.5 Class 150, BS 1560: 1989, BS 4504, JIS B 2220

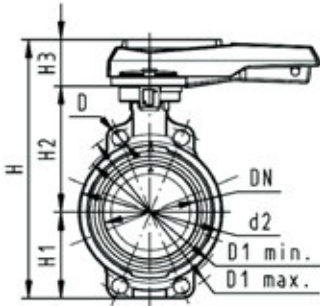

d (mm)	DN (mm)	PN (bar)	kv-value ( $\Delta p=1$ bar) (l/min)	EPDM Code	Weight (kg)
63	50	10	1470	<b>169 567 002</b>	1.187
75	65	10	2200	<b>169 567 003</b>	1.282
90	80	10	3000	<b>169 567 004</b>	1.420
110	100	10	6500	<b>169 567 005</b>	2.020
140	125	10	11500	<b>169 567 006</b>	2.536
160	150	10	16600	<b>169 567 007</b>	3.337
225	200	10	39600	<b>169 567 008</b>	5.808
280	250	10	55200	<b>169 567 009</b>	14.328
315	300	10	80000	<b>169 567 010</b>	18.899

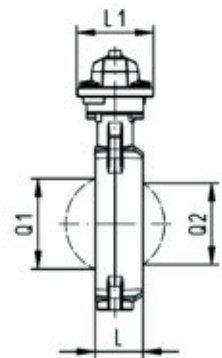

d (mm)	d2 (mm)	D (mm)	D1 min. (mm)	D1 max. (mm)	H (mm)	H1 (mm)	H2 (mm)	H3 (mm)	L (mm)	L1 (mm)	L2 (mm)	Q1 (mm)	Q2 (mm)
63	104	19	120.0	125.0	265	77	134	54	45	106	205	40	35
75	115	19	139.7	145.0	277	83	140	54	46	106	205	54	50
90	131	19	150.0	160.0	289	89	146	54	49	106	205	67	50
110	161	19	175.0	190.5	326	104	167	55	56	106	255	88	74
140	187	23	210.0	215.9	353	117	181	55	64	106	255	113	97
160	215	24	241.3	241.3	374	130	189	55	72	106	255	139	123
225	267	23	290.0	295.0	435	158	210	67	73	140	408	178	169
280	329	25	353.0	362.0	554	205	264	85	113	149	408	210	207
315	379	25	400.0	432.0	598	228	285	85	113	149	408	256	253

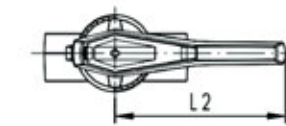

**Butterfly valve type 567 ABS**  
Reduction gear with handwheel

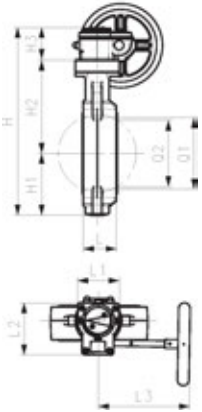
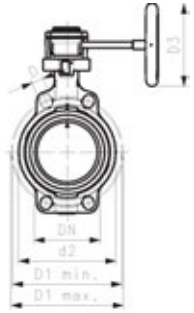

**Model:**

- Overall length according to EN 558, ISO 5752
- Connecting dimension: ISO 7005 PN 10, EN 1092 PN 10, DIN 2501 PN 10, ANSI/ASME B 16.5 Class 150, BS 1560: 1989, BS 4504, JIS B 2220

d (mm)	DN (mm)	PN (bar)	kv-value ( $\Delta p=1$ bar) (l/min)	EPDM Code	Weight (kg)
63	50	10	1470	<b>169 567 022</b>	3.078
75	65	10	2200	<b>169 567 023</b>	3.201
90	80	10	3000	<b>169 567 024</b>	3.259
110	100	10	6500	<b>169 567 025</b>	3.493
140	125	10	11500	<b>169 567 026</b>	4.526
160	150	10	16600	<b>169 567 027</b>	5.118
225	200	10	39600	<b>169 567 028</b>	6.389
280	250	10	51000	<b>169 567 029</b>	12.998
315	300	10	73000	<b>169 567 030</b>	19.139

d (mm)	d2 (mm)	D (mm)	D1 min. (mm)	D1 max. (mm)	D3 (mm)	H (mm)	H1 (mm)	H2 (mm)	H3 (mm)	L (mm)	L1 (mm)	L2 (mm)	L3 (mm)	Q1 (mm)
63	104	19	120	125	160	273	77	134	62	45	78	112	179	40
75	115	19	140	145	150	285	83	140	62	46	78	112	179	54
90	131	19	150	160	150	297	89	146	62	49	78	112	179	67
110	160	19	175	191	150	333	104	167	62	56	78	112	179	88
140	187	23	210	216	150	360	117	181	62	64	78	112	179	113
160	215	24	241	241	160	381	130	189	62	72	78	112	179	139
225	267	23	290	295	160	430	158	210	62	73	78	112	179	178
280	329	25	353	362	200	538	205	264	69	113	97	130	198	210
315	379	25	400	432	200	582	228	285	69	113	97	130	198	256

d (mm)	Q2 (mm)
63	
75	35
90	50
110	74
140	97
160	123
225	169
280	207
315	253

# Butterfly Valves Type 578



## Lugstyle butterfly valve type 578 ABS Bare shaft

### Model:

- Housing material: PP-GF30 with SS316 lug-inserts
- Overall length according to EN 558, ISO 5752 (DN50 - 200 line 25, DN250 - 300 line 10)
- Connecting dimension: ISO 7005 PN10, EN 1092 PN10, DIN 2501 PN10
- Interface F07 according to DIN/ISO 5211

### Option:

- Optional accessory: Valve-Integrated position feedback with limit switches (limit switches have to be ordered separately)

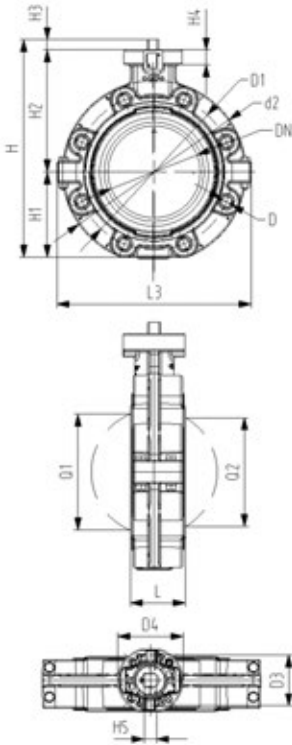

d (mm)	DN (mm)	PN (bar)	kv-value ( $\Delta p=1$ bar) (l/min)	EPDM Code	Weight (kg)
63	50	10	1470	<b>169 578 802</b>	1.299
75	65	10	2200	<b>169 578 803</b>	1.456
90	80	10	3000	<b>169 578 804</b>	1.701
110	100	10	6500	<b>169 578 805</b>	2.606
140	125	10	11500	<b>169 578 806</b>	4.120
160	150	10	16600	<b>169 578 807</b>	5.881
225	200	10	39600	<b>169 578 808</b>	7.125
280	250	10	55200	<b>169 578 809</b>	17.880
315	300	10	80000	<b>169 578 810</b>	24.416

d (mm)	d2 (mm)	D	D1 (mm)	D3 (mm)	D4 (mm)	H (mm)	H1 (mm)	H2 (mm)	H3 (mm)	H4 (mm)	H5 (mm)	L (mm)	L3 (mm)	Q1 (mm)	Q2 (mm)
63	160	M16	125	70	90	238	77	134	27	23	11	45	165	40	
75	180	M16	145	70	90	250	83	140	27	23	11	46	182	54	35
90	195	M16	160	70	90	262	89	146	27	23	11	49	210	67	50
110	226	M16	180	70	90	289	106	167	16	23	14	56	240	88	74
140	258	M16	210	70	90	318	121	181	16	23	14	64	272	113	97
160	284	M20	240	70	90	341	133	189	19	23	17	72	300	139	123
225	341	M20	295	70	90	388	159	210	19	23	17	73	360	178	169
280	412	M20	350	200	125	555	205	264	86	23	22	113	440	210	207
315	482	M20	400	200	125	605	234	285	86	23	22	113	510	256	253



## Lugstyle butterfly valve type 578 ABS

### Hand lever with ratchet settings

#### Model:

- Housing material: PP-GF30 with SS316 lug-inserts
- Overall length according to EN 558, ISO 5752 (DN50 - 200 line 25, DN250 - 300 line 10)
- Connecting dimension: ISO 7005 PN10, EN 1092 PN10, DIN 2501 PN10

#### Option:

- Optional accessory: Valve-Integrated position feedback with limit switches (limit switches have to be ordered separately)

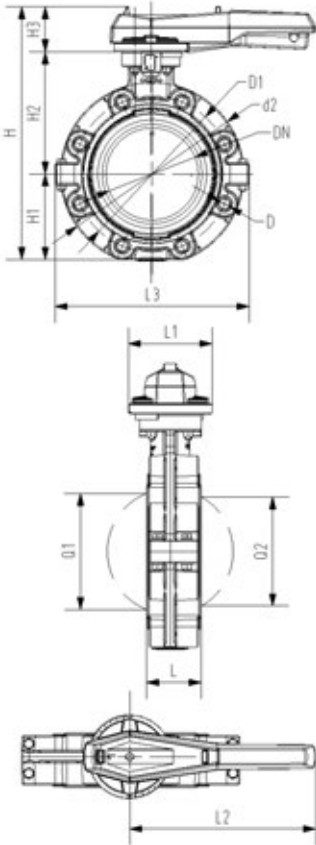

d (mm)	DN (mm)	PN (bar)	kv-value ( $\Delta p=1$ bar) (l/min)	EPDM Code	Weight (kg)
63	50	10	1470	<b>169 578 002</b>	1.800
75	65	10	2200	<b>169 578 003</b>	1.895
90	80	10	3000	<b>169 578 004</b>	2.251
110	100	10	6500	<b>169 578 005</b>	3.146
140	125	10	11500	<b>169 578 006</b>	4.660
160	150	10	16600	<b>169 578 007</b>	6.430
225	200	10	39600	<b>169 578 008</b>	8.625
280	250	10	55200	<b>169 578 009</b>	19.528
315	300	10	80000	<b>169 578 010</b>	26.106

d (mm)	d2 (mm)	D	D1 (mm)	H (mm)	H1 (mm)	H2 (mm)	H3 (mm)	L (mm)	L1 (mm)	L2 (mm)	L3 (mm)	Q1 (mm)	Q2 (mm)
63	160	M16	125	265	77	134	54	45	106	205	165	40	
75	180	M16	145	277	83	140	54	46	106	205	182	54	35
90	195	M16	160	289	89	146	54	49	106	205	210	67	50
110	226	M16	180	328	106	167	55	56	106	255	240	88	74
140	258	M16	210	357	121	181	55	64	106	255	272	113	97
160	284	M20	240	377	133	189	55	72	106	255	300	139	123
225	341	M20	295	436	159	210	67	73	140	408	360	178	169
280	412	M20	350	538	205	264	69	113	97	130	198	210	207
315	482	M20	400	588	234	285	69	113	97	130	198	256	253



**Lugstyle butterfly valve type 578 ABS**  
**Reduction gear with handwheel**

**Model:**

- Housing material: PP-GF30 with SS316 lug-inserts
- Overall length according to EN 558, ISO 5752 (DN50 - 200 line 25, DN250 - 300 line 10)
- Connecting dimension: ISO 7005 PN10, EN 1092 PN10, DIN 2501 PN10

**Option:**

- Optional accessory: Valve-Integrated position feedback with limit switches (limit switches have to be ordered separately)

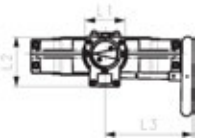
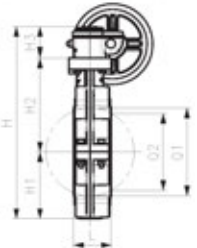

d (mm)	DN (mm)	PN (bar)	kv-value ( $\Delta p=1$ bar) (l/min)	EPDM Code	Weight (kg)
63	50	10	1470	<b>169 578 022</b>	3.467
75	65	10	2200	<b>169 578 023</b>	3.610
90	80	10	3000	<b>169 578 024</b>	3.929
110	100	10	6500	<b>169 578 025</b>	4.834
140	125	10	11500	<b>169 578 026</b>	6.348
160	150	10	16600	<b>169 578 027</b>	8.109
225	200	10	39600	<b>169 578 028</b>	9.353
280	250	10	55200	<b>169 578 029</b>	19.528
315	300	10	80000	<b>169 578 030</b>	26.106

d (mm)	d2 (mm)	D	D1 (mm)	D3 (mm)	H (mm)	H1 (mm)	H2 (mm)	H3 (mm)	L (mm)	L1 (mm)	L2 (mm)	L3 (mm)	L4 (mm)	Q1 (mm)	Q2 (mm)
63	160	M16	125	160	273	77	134	62	45	78	112	179	155	165	
75	180	M16	145	150	285	83	140	62	46	78	112	179	155	182	35
90	195	M16	160	150	297	89	146	62	49	78	112	179	155	210	50
110	226	M16	180	150	335	106	167	62	56	78	112	179	155	240	74
140	258	M16	210	150	364	121	181	62	64	78	112	179	155	272	97
160	284	M20	240	160	384	133	189	62	72	78	112	179	155	300	123
225	341	M20	295	150	419	159	210	50	73	110	120	360	155	178	169
280	412	M20	350	200	536	205	264	67	113	100	131	440	170	210	207
315	482	M20	400	200	586	234	285	67	113	100	131	510	170	256	253



## Lugstyle butterfly valve type 578 ABS Bare shaft

### Model:

- Housing material: PP-GF30 with SS316 lug-inserts
- Overall length according to EN 558, ISO 5752 (DN50 - 200 line 25, DN250 - 300 line 10)
- Connecting dimension: ANSI/ASME B 16.5 class 150, ASTM D 4024, BS 1560, BS EN 1759
- Interface F07 according to DIN/ISO 5211

### Option:

- Optional accessory: Valve-Integrated position feedback with limit switches (limit switches have to be ordered separately)

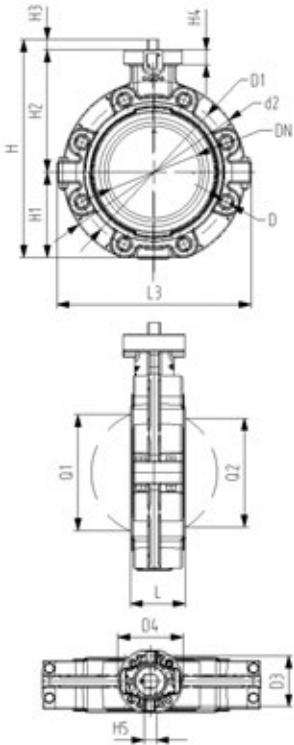

Size (inch)	d (mm)	DN (mm)	PN (bar)	kv-value ( $\Delta p=1$ bar) (l/min)	EPDM Code	Weight (kg)
2	63	50	10	1470	<b>169 578 902</b>	1.299
2 ½	75	65	10	2200	<b>169 578 903</b>	1.456
3	90	80	10	3000	<b>169 578 904</b>	1.701
4	110	100	10	6500	<b>169 578 905</b>	2.606
5	140	125	10	11500	<b>169 578 906</b>	4.120
6	160	150	10	16600	<b>169 578 907</b>	5.881
8	225	200	10	39600	<b>169 578 908</b>	7.125
10	280	250	10	55200	<b>169 578 909</b>	17.880
12	315	300	10	80000	<b>169 578 910</b>	24.416

Size (inch)	d2 (mm)	D	D1 (mm)	D3 (mm)	D4 (mm)	H (mm)	H1 (mm)	H2 (mm)	H3 (mm)	H4 (mm)	H5 (mm)	L (mm)	L3 (mm)	Q1 (mm)
2	160	UNC 5/8	120.6	70	90	238	77	134	27	23	11	45	165	40
2 ½	180	UNC 5/8	139.7	70	90	250	83	140	27	23	11	46	182	54
3	195	UNC 5/8	152.4	70	90	262	89	146	27	23	11	49	210	67
4	226	UNC 5/8	190.5	70	90	289	106	167	16	23	14	56	240	88
5	258	UNC 3/4	215.9	70	90	318	121	181	16	23	14	64	272	113
6	284	UNC 3/4	241.3	70	90	341	133	189	19	23	17	72	300	139
8	341	UNC 3/4	298.4	70	90	388	159	210	19	23	17	73	360	178
10	412	UNC 7/8	362.0	102	125	559	234	285	40	23	22	113	510	256
12	482	UNC 7/8	431.8	102	125	509	205	264	40	23	22	113	440	210

Size (inch)	Q2 (mm)
2	
2 ½	35
3	50
4	74
5	97
6	123
8	169
10	253
12	207





**Lugstyle butterfly valve type 578 ABS**  
**Hand lever with ratchet settings**

**Model:**

- Housing material: PP-GF30 with SS316 lug-inserts
- Overall length according to EN 558, ISO 5752 (DN50 - 200 line 25, DN250 - 300 line 10)
- Connecting dimension: ANSI/ASME B 16.5 class 150, ASTM D 4024, BS 1560, BS EN 1759

**Option:**

- Optional accessory: Valve-Integrated position feedback with limit switches (limit switches have to be ordered separately)

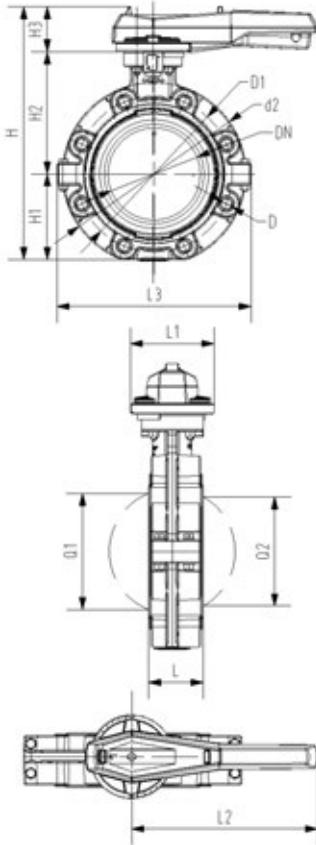

Size (inch)	d (mm)	DN (mm)	PN (bar)	kv-value ( $\Delta p=1$ bar) (l/min)	EPDM Code	Weight (kg)
2	63	50	10	1470	<b>169 578 102</b>	1.800
2 ½	75	65	10	2200	<b>169 578 103</b>	1.895
3	90	80	10	3000	<b>169 578 104</b>	2.251
4	110	100	10	6500	<b>169 578 105</b>	3.146
5	140	125	10	11500	<b>169 578 106</b>	4.660
6	160	150	10	16600	<b>169 578 107</b>	6.430
8	225	200	10	39600	<b>169 578 108</b>	8.625
10		250	10	55200	<b>169 578 109</b>	19.528
12		300	10	80000	<b>169 578 110</b>	26.106

Size (inch)	d2 (mm)	D	D1 (mm)	H (mm)	H1 (mm)	H2 (mm)	H3 (mm)	L (mm)	L1 (mm)	L2 (mm)	L3 (mm)	Q1 (mm)	Q2 (mm)
2	160	UNC 5/8	120.6	265	77	134	54	45	106	205	165	40	
2 ½	180	UNC 5/8	139.7	277	83	140	54	46	106	205	182	54	35
3	195	UNC 5/8	152.4	289	89	146	54	49	106	205	210	67	50
4	226	UNC 5/8	190.5	328	106	167	55	56	106	255	240	88	74
5	258	UNC 3/4	215.9	357	121	181	55	64	106	255	272	113	97
6	284	UNC 3/4	241.3	377	133	189	55	72	106	255	300	139	123
8	341	UNC 3/4	298.4	436	159	210	67	73	140	408	360	178	169
10	412	UNC 7/8	362.0	536	205	264	67	113	140	408	440	210	207
12	482	UNC 7/8	431.8	586	234	285	67	113	140	408	510	256	253



**Lugstyle butterfly valve type 578 ABS**  
**Reduction gear with handwheel**

**Model:**

- Housing material: PP-GF30 with SS316 lug-inserts
- Overall length according to EN 558, ISO 5752 (DN50 - 200 line 25, DN250 - 300 line 10)
- Connecting dimension: ANSI/ASME B 16.5 class 150, ASTM D 4024, BS 1560, BS EN 1759

**Option:**

- Optional accessory: Valve-Integrated position feedback with limit switches (limit switches have to be ordered separately)

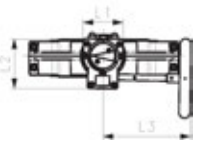
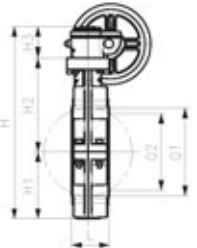

Size (inch)	d (mm)	DN (mm)	PN (bar)	kv-value ( $\Delta p=1$ bar) (l/min)	EPDM Code	Weight (kg)
2	63	50	10	1470	<b>169 578 122</b>	3.467
2 ½	75	65	10	2200	<b>169 578 123</b>	3.610
3	90	80	10	3000	<b>169 578 124</b>	3.929
4	110	100	10	6500	<b>169 578 125</b>	4.834
5	140	125	10	11500	<b>169 578 126</b>	6.348
6	160	150	10	16600	<b>169 578 127</b>	8.109
8	225	200	10	39600	<b>169 578 128</b>	9.353
10		250	10	55200	<b>169 578 129</b>	19.528
12		300	10	80000	<b>169 578 130</b>	26.106

Size (inch)	d2 (mm)	D	D1 (mm)	D3 (mm)	H (mm)	H1 (mm)	H2 (mm)	H3 (mm)	H4 (mm)	L (mm)	L1 (mm)	L2 (mm)	L3 (mm)	L4 (mm)
2	160	UNC 5/8	120.6	150	273	77	134	62	23	45	78	112	179	165
2 ½	180	UNC 5/8	139.7	150	285	83	140	62	23	46	78	112	179	182
3	195	UNC 5/8	152.4	150	297	89	146	62	23	49	78	112	179	210
4	226	UNC 5/8	190.5	150	335	106	167	62	23	56	78	112	179	240
5	258	UNC 3/4	215.9	150	364	121	181	62	23	64	78	112	179	272
6	284	UNC 3/4	241.3	160	384	133	189	62	23	72	78	112	179	300
8	341	UNC 3/4	298.4	160	431	159	210	62	23	73	78	112	179	360
10	412	UNC 7/8	362.0	200	524	205	264	55	23	113	130	140	440	200
12	482	UNC 7/8	431.8	200	574	234	285	55	23	113	130	140	510	200

Size (inch)	Q1 (mm)	Q2 (mm)
2	40	
2 ½	54	35
3	67	50
4	88	74
5	113	97
6	139	123
8	178	169
10	210	207
12	256	253

# Metal Butterfly Valves Type 039 and 038

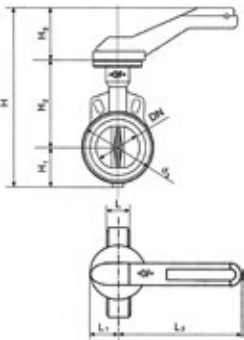

## Metal - butterfly valve type 039M With hand lever

### Model:

- Body GGG40 (A 395 M:88, EN-JS 1020 EN1563) Rilsan coating
- Seat Material: EPDM, FPM and others on request
- Full bore shaft, square shape
- Installation length: EN 558 row 20
- Mounting between ISO, ANSI, BS or JIS Flanges
- Interface according to DIN/ISO 5211
- Also available: gearbox with handwheel, electric-, pneumatic actuated

d (mm)	Size (inch)	DN (mm)	PN (bar)	kv-value ( $\Delta p=1$ bar) (l/min)	Disc: ductile iron/Rilsan® coated EPDM Code	Disc: stainless steel EPDM Code	Disc: Alu- bronze EPDM Code	Weight (kg)
63	2	50	16	3167	199 039 000	199 039 200	199 039 400	1.800
75	2 ½	65	16	4667	199 039 001	199 039 201	199 039 401	2.100
90	3	80	16	7167	199 039 002	199 039 202	199 039 402	2.300
110	4	100	16	11833	199 039 003	199 039 203	199 039 403	3.500
140	5	125	16	18333	199 039 004	199 039 204	199 039 404	8.000
160	6	150	16	26667	199 039 005	199 039 205	199 039 405	5.700
225	8	200	16	46667	199 039 006	199 039 206	199 039 406	8.400
280	10	250	16	78333	199 039 007	199 039 207	199 039 407	17.000
315	12	300	16	115000	199 039 008	199 039 208	199 039 408	21.000

d (mm)	Size (inch)	DN (mm)	PN (bar)	kv-value ( $\Delta p=1$ bar) (l/min)	d3 (mm)	H (mm)	H1 (mm)	H2 (mm)	H3 (mm)	L (mm)	L1 (mm)	L2 (mm)	Cv value ( $\Delta p=1$ psi) (l/min)
63	2	50	16	3167	95	290	53	140	95	43	45	220	837
75	2 ½	65	16	4667	114	312	63	152	95	46	45	220	1233
90	3	80	16	7167	131	327	71	159	95	46	45	220	1893
110	4	100	16	11833	152	360	87	178	95	52	45	220	3126
140	5	125	16	18333	182	388	102	191	95	56	45	320	4843
160	6	150	16	26667	209	416	118	203	95	56	45	320	7045
225	8	200	16	46667	262	489	149	245	95	60	45	320	12328
280	10	250	16	78333	331	525	200	275	50	68	63	560	20693
315	12	300	16	115000	380	592	227	315	50	78	63	560	30380



**Metal - butterfly valve type 039G**  
**Reduction gear with handwheel**

**Model:**

- Body GGG40 (A 395 M:88, EN-JS 1020 EN1563) Rilsan coating
- Seat Material: EPDM, FPM and others on request
- Full bore shaft, square shape
- Installation length: EN 558 row 20
- Mounting between ISO, ANSI, BS or JIS Flanges
- Interface according to DIN/ISO 5211

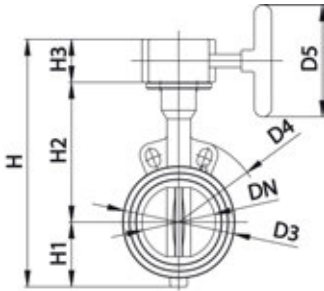

d	Size	DN	PN	kv-value	Disc: ductile	Disc:	Disc: Alu-	Weight
(mm)	(inch)	(mm)	(bar)	( $\Delta p=1$ bar)	iron/Rilsan®	stainless	bronze	(kg)
				(L/min)	coated	steel EPDM	EPDM	
					EPDM	Code	Code	
					Code			
63	2	50	16	3167	199 039 026	199 039 226	199 039 426	3.300
75	2 ½	65	16	4667	199 039 027	199 039 227	199 039 427	3.600
90	3	80	16	7167	199 039 028	199 039 228	199 039 428	3.800
110	4	100	16	11833	199 039 029	199 039 229	199 039 429	4.800
140	5	125	16	18333	199 039 030	199 039 230	199 039 430	5.600
160	6	150	16	26667	199 039 031	199 039 231	199 039 431	7.000
225	8	200	16	46667	199 039 032	199 039 232	199 039 432	9.500
280	10	250	16	78333	199 039 033	199 039 233	199 039 433	19.000
315	12	300	16	115000	199 039 034	199 039 234	199 039 434	23.000

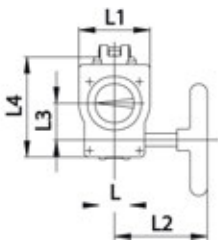

d	Size	DN	PN	kv-value	D3	D4	D5	H	H1	H2	H3	L1	L2	L3
(mm)	(inch)	(mm)	(bar)	( $\Delta p=1$ bar)	(mm)	(mm)	(mm)	(mm)	(mm)	(mm)	(mm)	(mm)	(mm)	(mm)
				(L/min)										
63	2	50	16	3167	95	165	125	253	55	140	58	84	152	38
75	2 ½	65	16	4667	114	185	125	275	65	152	58	84	152	38
90	3	80	16	7167	131	190	125	290	73	159	58	84	152	38
110	4	100	16	11833	152	229	125	323	87	178	58	84	152	38
140	5	125	16	18333	182	254	125	351	102	191	58	84	152	38
160	6	150	16	26667	209	285	125	379	118	203	58	84	152	38
225	8	200	16	46667	262	343	125	452	149	245	58	84	152	38
280	10	250	16	78333	331	333	250	542	200	275	67	106	184	52
315	12	300	16	115000	380	353	250	609	227	315	67	106	184	52

d	Size	DN	PN	kv-value	L4	Cv value
(mm)	(inch)	(mm)	(bar)	( $\Delta p=1$ bar)	(mm)	( $\Delta p=1$ psi)
				(L/min)		(L/min)
63	2	50	16	3167	107	837
75	2 ½	65	16	4667	107	1233
90	3	80	16	7167	107	1893
110	4	100	16	11833	107	3126
140	5	125	16	18333	107	4843
160	6	150	16	26667	107	7045
225	8	200	16	46667	107	12328
280	10	250	16	78333	142	20693
315	12	300	16	115000	142	30380



**Metal - butterfly valve type 038M**  
**With hand lever**

**Model:**

- Seat Material: EPDM, FPM and others on request
- Housing: ductile iron GGG-40/ASTM A536, Rilsan® coated
- Available in ANSI standard upon request
- In case this valve is used at the end of the line, the following pressures must not be exceeded:  
 DN50 to DN150 5,6bar and > DN200 3,5bar

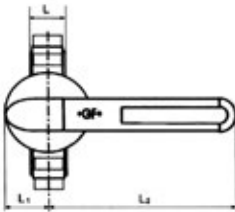
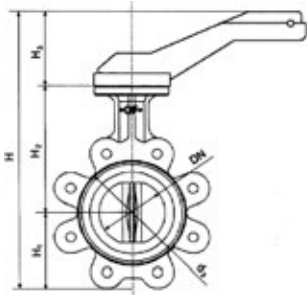

d (mm)	Size (inch)	DN (mm)	PN (bar)	kv-value ( $\Delta p=1$ bar) (l/min)	Disc: ductile iron/Rilsan® coated EPDM Code	Disc: ductile iron/Rilsan® coated FPM Code	Disc: stainless steel EPDM Code	Disc: stainless steel FPM Code
63	2	50	16	3140	199 038 000	199 038 013	199 038 200	199 038 213
75	2 ½	65	16	4570	199 038 001	199 038 014	199 038 201	199 038 214
90	3	80	16	7140	199 038 002	199 038 015	199 038 202	199 038 215
110	4	100	16	11710	199 038 003	199 038 016	199 038 203	199 038 216
140	5	125	16	18570	199 038 004	199 038 017	199 038 204	199 038 217
160	6	150	16	27130	199 038 005	199 038 018	199 038 205	199 038 218
225	8	200	16	47130	199 038 006	199 038 019	199 038 206	199 038 219
280	10	250	16	77110	199 038 007	199 038 020	199 038 207	199 038 220
315	12	300	16	114240	199 038 008	199 038 021	199 038 208	199 038 221

d (mm)	Size (inch)	DN (mm)	PN (bar)	kv-value ( $\Delta p=1$ bar) (l/min)	Disc: Alu- bronze EPDM Code	Disc: Alu- bronze FPM Code	Weight (kg)
63	2	50	16	3140	199 038 400	199 038 413	3.800
75	2 ½	65	16	4570	199 038 401	199 038 414	4.900
90	3	80	16	7140	199 038 402	199 038 415	5.400
110	4	100	16	11710	199 038 403	199 038 416	9.100
140	5	125	16	18570	199 038 404	199 038 417	11.000
160	6	150	16	27130	199 038 405	199 038 418	12.800
225	8	200	16	47130	199 038 406	199 038 419	19.300
280	10	250	16	77110	199 038 407	199 038 420	35.000
315	12	300	16	114240	199 038 408	199 038 421	49.000

d (mm)	Size (inch)	DN (mm)	PN (bar)	kv-value ( $\Delta p=1$ bar) (l/min)	d3 (mm)	H (mm)	H1 (mm)	H2 (mm)	H3 (mm)	L (mm)	L1 (mm)	L2 (mm)	Cv value ( $\Delta p=1$ psi) (l/min)
63	2	50	16	3140	95	298	63	140	95	43	45	220	220
75	2 ½	65	16	4570	114	320	73	152	95	46	45	220	320
90	3	80	16	7140	131	335	81	159	95	46	45	220	500
110	4	100	16	11710	152	370	97	178	95	52	45	220	820
140	5	125	16	18570	182	398	112	181	95	56	45	320	1300
160	6	150	16	27130	209	420	122	203	95	56	45	320	1900
225	8	200	16	47130	262	489	149	245	95	60	45	320	3330
280	10	250	16	77110	331	573	203	275	48	68	63	560	5400
315	12	300	16	114240	380	651	241	315	48	78	63	560	8000



**Metal - butterfly valve type 038G**  
**Reduction gear with handwheel**

**Model:**

- Seat Material: EPDM, FPM and others on request
- Housing: ductile iron GGG-40/ASTM A536, Rilsan® coated
- Available in ANSI standard upon request
- In case this valve is used at the end of the line, the following pressures must not be exceeded:  
 DN50 to DN150 5,6bar and > DN200 3,5bar

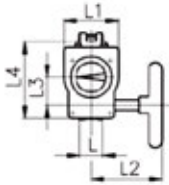
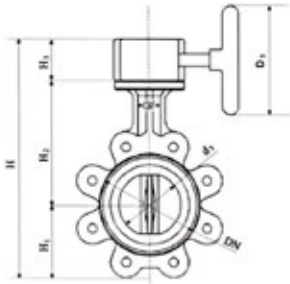

d (mm)	Size (inch)	DN (mm)	PN (bar)	kv-value ( $\Delta p=1$ bar) (l/min)	Disc: ductile iron/Rilsan® coated EPDM Code	Disc: ductile iron/Rilsan® coated FPM Code	Disc: stainless steel EPDM Code	Disc: stainless steel FPM Code
63	2	50	16	3140	199 038 026	199 038 039	199 038 226	199 038 239
75	2 ½	65	16	4570	199 038 027	199 038 040	199 038 227	199 038 240
90	3	80	16	7140	199 038 028	199 038 041	199 038 228	199 038 241
110	4	100	16	11710	199 038 029	199 038 042	199 038 229	199 038 242
140	5	125	16	18570	199 038 030	199 038 043	199 038 230	199 038 243
160	6	150	16	27130	199 038 031	199 038 044	199 038 231	199 038 244
225	8	200	16	47130	199 038 032	199 038 045	199 038 232	199 038 245
280	10	250	16	77110	199 038 033	199 038 046	199 038 233	199 038 246
315	12	300	16	114240	199 038 034	199 038 047	199 038 234	199 038 247

d (mm)	Size (inch)	DN (mm)	PN (bar)	kv-value ( $\Delta p=1$ bar) (l/min)	Disc: Alu- bronze EPDM Code	Disc: Alu- bronze FPM Code	Weight (kg)
63	2	50	16	3140	199 038 426	199 038 439	5.300
75	2 ½	65	16	4570	199 038 427	199 038 440	6.400
90	3	80	16	7140	199 038 428	199 038 441	6.900
110	4	100	16	11710	199 038 429	199 038 442	10.400
140	5	125	16	18570	199 038 430	199 038 443	12.300
160	6	150	16	27130	199 038 431	199 038 444	14.100
225	8	200	16	47130	199 038 432	199 038 445	20.400
280	10	250	16	77110	199 038 433	199 038 446	37.000
315	12	300	16	114240	199 038 434	199 038 447	51.000

d (mm)	Size (inch)	DN (mm)	PN (bar)	kv-value ( $\Delta p=1$ bar) (l/min)	d3 (mm)	D5 (mm)	H (mm)	H1 (mm)	H2 (mm)	H3 (mm)	L (mm)	L1 (mm)	L2 (mm)	L3 (mm)
63	2	50	16	3140	95	125	261	63	140	58	43	84	152	38
75	2 ½	65	16	4570	114	125	283	73	152	58	46	84	152	38
90	3	80	16	7140	131	125	298	81	159	58	46	84	152	38
110	4	100	16	11710	152	125	333	97	178	58	52	84	152	38
140	5	125	16	18570	182	125	361	112	191	58	56	84	152	38
160	6	150	16	27130	209	125	383	122	203	58	56	84	152	38
225	8	200	16	47130	262	125	452	149	245	58	60	84	152	38
280	10	250	16	77110	331	250	545	203	275	67	68	106	152	52
315	12	300	16	114240	380	250	623	241	315	67	78	106	152	52

d (mm)	Size (inch)	DN (mm)	PN (bar)	kv-value ( $\Delta p=1$ bar) (l/min)	L4 (mm)	Cv value ( $\Delta p=1$ psi) (l/min)
63	2	50	16	3140	107	220
75	2 ½	65	16	4570	107	320
90	3	80	16	7140	107	500
110	4	100	16	11710	107	820
140	5	125	16	18570	107	1300
160	6	150	16	27130	107	1900
225	8	200	16	47130	107	3330
280	10	250	16	77110	141	5400
315	12	300	16	114240	141	8000

# Angle Seat Check Valves



**Angle seat check valve type 303 ABS**  
**With solvent cement spigots metric**

**Model:**

- For horizontal or vertical installation
- Leakproof from: EPDM 2m, FPM 3m water column
- Specific gravity of piston approx. 2 kg/dm<sup>3</sup>
- Overall length EN 558

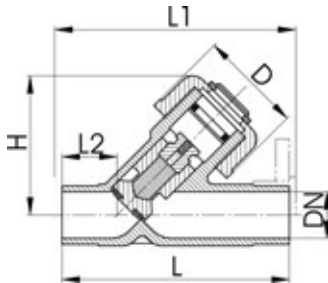

d (mm)	DN (mm)	PN (bar)	kv-value ( $\Delta p=1$ bar) (l/min)	EPDM Code	Weight (kg)	D (mm)	H (mm)	L (mm)	L1 (mm)	L2 (mm)
20	15	10	95	<b>169 303 006</b>	0.092	43	65	124	130	28
25	20	10	180	<b>169 303 007</b>	0.133	47	75	144	150	37
32	25	10	327	<b>169 303 008</b>	0.219	56	90	154	160	37
40	32	10	484	<b>169 303 009</b>	0.348	64	102	174	180	44
50	40	10	725	<b>169 303 010</b>	0.615	82	123	194	200	48
63	50	10	1130	<b>169 303 011</b>	1.059	95	144	224	230	60



# Cone Check (non-return) Valves



## Check valve type 561 ABS With solvent cement sockets Inch BS

### Model:

- Sealing at a minimum water column of 2m
- Designed for easy installation and removal
- Vibration free even at high flow velocity
- Flow-optimized return cone, double guided
- For vertical installation
- Compact installation length, same as ball valve type 546
- Z-length, end connectors and union nuts **not** compatible with type 360
- New DN65-DN100

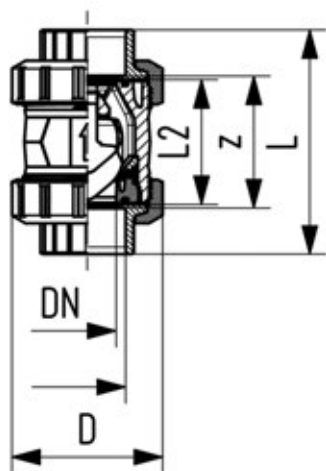

Size (inch)	DN (mm)	PN (bar)	kv-value ( $\Delta p=1$ bar) (l/min)	EPDM Code	Weight (kg)	D (mm)	L (mm)	L2 (mm)	z (mm)
3/8	10	10	190	169 561 061	0.090	50	92	56	60
1/2	15	10	180	169 561 062	0.090	50	95	56	60
3/4	20	10	380	169 561 063	0.190	58	110	65	69
1	25	10	460	169 561 064	0.210	68	123	71	75
1 1/4	32	10	850	169 561 065	0.370	84	146	85	89
1 1/2	40	10	1080	169 561 066	0.570	97	157	89	97
2	50	10	1670	169 561 067	1.000	124	183	101	110
2 1/2	65	10	2950	169 561 068	2.420	166	233	136	144
3	80	10	3600	169 561 069	3.890	200	254	141	151
4	100	10	4150	169 561 070	6.140	238	301	164	174

## Check valve type 561 ABS With solvent cement sockets metric

### Model:

- Sealing at a minimum water column of 2m
- Designed for easy installation and removal
- Vibration free even at high flow velocity
- Flow-optimized return cone, double guided
- For vertical installation
- Compact installation length, same as ball valve type 546
- Z-length, end connectors and union nuts **not** compatible with type 360
- New DN65-DN100

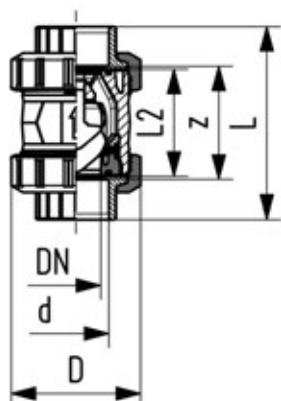

d (mm)	DN (mm)	PN (bar)	kv-value ( $\Delta p=1$ bar) (l/min)	EPDM Code	Weight (kg)	D (mm)	L (mm)	L2 (mm)	z (mm)
16	10	10	190	169 561 001	0.090	50	92	56	64
20	15	10	180	169 561 002	0.090	50	95	56	64
25	20	10	380	169 561 003	0.190	58	110	65	72
32	25	10	460	169 561 004	0.220	68	123	71	79
40	32	10	850	169 561 005	0.380	84	146	85	94
50	40	10	1080	169 561 006	0.560	97	157	89	95
63	50	10	1670	169 561 007	0.990	124	183	101	107
75	65	10	2950	169 561 008	2.420	166	233	136	144
90	80	10	3600	169 561 009	3.870	200	254	141	151
110	100	10	4150	169 561 010	6.240	238	301	164	174



**Check valve type 561 ABS**  
With threaded sockets Rp

**Model:**

- Sealing at a minimum water column of 2m
- Designed for easy installation and removal
- Vibration free even at high flow velocity
- Flow-optimized return cone, double guided
- For vertical installation
- Compact installation length, same as ball valve type 546
- Z-length, end connectors and union nuts **not** compatible with type 360

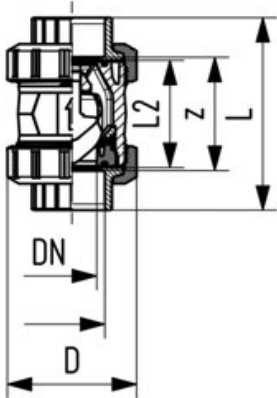

Rp (inch)	DN (mm)	PN (bar)	kv-value ( $\Delta p=1$ bar) (L/min)	EPDM Code	Weight (kg)	D (mm)	L (mm)	L2 (mm)	z (mm)
3/8	10	10	190	<b>169 561 021</b>	0.090	50	95	56	69
1/2	15	10	180	<b>169 561 022</b>	0.100	50	100	56	67
3/4	20	10	380	<b>169 561 023</b>	0.200	58	114	65	78
1	25	10	460	<b>169 561 024</b>	0.220	68	127	71	85
1 1/4	32	10	850	<b>169 561 025</b>	0.380	84	146	85	100
1 1/2	40	10	1080	<b>169 561 026</b>	0.580	97	152	89	106
2	50	10	1670	<b>169 561 027</b>	1.040	124	177	101	121

**Check valve type 562 ABS**  
With solvent cement sockets Inch BS



**Model:**

- For horizontal or vertical installation
- Sealing at a minimum water column of 1m
- Spring loaded, spring made of stainless steel (1.4310)
- Spring available in other materials, see spare parts
- Designed for easy installation and removal
- Vibration free even at high flow velocity
- Flow-optimized return cone, double guided
- Compact installation length, same as ball valve type 546
- Z-length, end connectors and union nuts **not** compatible with type 360
- New DN65-DN100

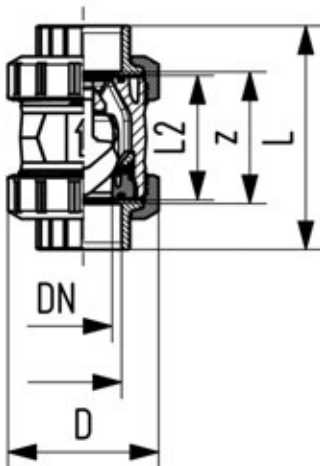

Size (inch)	DN (mm)	PN (bar)	kv-value ( $\Delta p=1$ bar) (L/min)	EPDM Code	Weight (kg)	D (mm)	L (mm)	L2 (mm)	z (mm)
3/8	10	10	190	<b>169 562 061</b>	0.090	50	92	56	60
1/2	15	10	180	<b>169 562 062</b>	0.090	50	95	56	60
3/4	20	10	380	<b>169 562 063</b>	0.190	58	110	65	69
1	25	10	460	<b>169 562 064</b>	0.210	68	123	71	75
1 1/4	32	10	850	<b>169 562 065</b>	0.370	84	146	85	89
1 1/2	40	10	1080	<b>169 562 066</b>	0.570	97	157	89	97
2	50	10	1670	<b>169 562 067</b>	1.000	124	183	101	110
2 1/2	65	10	2950	<b>169 562 068</b>	2.420	166	233	136	144
3	80	10	3600	<b>169 562 069</b>	3.890	200	254	141	151
4	100	10	4150	<b>169 562 070</b>	6.140	238	301	164	174



**Check valve type 562 ABS**  
With solvent cement sockets metric

**Model:**

- For horizontal or vertical installation
- Sealing at a minimum water column of 1m
- Spring loaded, spring made of stainless steel (1.4310)
- Spring available in other materials, see spare parts
- Designed for easy installation and removal
- Vibration free even at high flow velocity
- Flow-optimized return cone, double guided
- Compact installation length, same as ball valve type 546
- Z-length, end connectors and union nuts **not** compatible with type 360
- New DN65-DN100

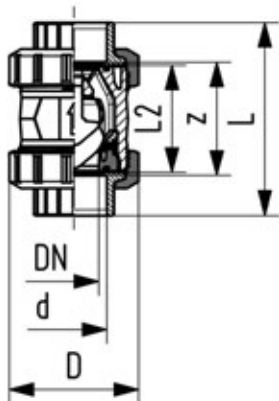

d (mm)	DN (mm)	PN (bar)	kv-value ( $\Delta p=1$ bar) (l/min)	EPDM Code	Weight (kg)	D (mm)	L (mm)	L2 (mm)	z (mm)
16	10	10	190	169 562 001	0.090	50	92	56	64
20	15	10	180	169 562 002	0.090	50	95	56	64
25	20	10	380	169 562 003	0.190	58	110	65	72
32	25	10	460	169 562 004	0.220	68	123	71	79
40	32	10	850	169 562 005	0.380	84	146	85	94
50	40	10	1080	169 562 006	0.560	97	157	89	95
63	50	10	1670	169 562 007	0.990	124	183	101	107
75	65	10	2950	169 562 008	2.420	166	233	136	144
90	80	10	3600	169 562 009	3.870	200	254	141	151
110	100	10	4150	169 562 010	6.240	238	301	164	174



**Check valve type 562 ABS**  
With threaded sockets Rp

**Model:**

- For horizontal or vertical installation
- Sealing at a minimum water column of 1m
- Spring loaded, spring made of stainless steel (1.4310)
- Spring available in other materials, see spare parts
- Designed for easy installation and removal
- Vibration free even at high flow velocity
- Flow-optimized return cone, double guided
- Compact installation length, same as ball valve type 546
- Z-length, end connectors and union nuts **not** compatible with type 360

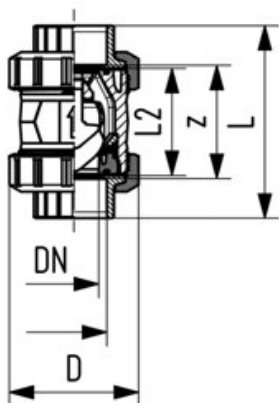

Rp (inch)	DN (mm)	PN (bar)	kv-value ( $\Delta p=1$ bar) (l/min)	EPDM Code	Weight (kg)	D (mm)	L (mm)	L2 (mm)	z (mm)
3/8	10	10	190	169 562 021	0.090	50	95	56	69
1/2	15	10	180	169 562 022	0.100	50	100	56	67
3/4	20	10	380	169 562 023	0.200	58	114	65	78
1	25	10	460	169 562 024	0.220	68	127	71	85
1 1/4	32	10	850	169 562 025	0.380	84	146	85	100
1 1/2	40	10	1080	169 562 026	0.580	97	152	89	106
2	50	10	1670	169 562 027	1.040	124	177	101	121

# Process Control Valves

## Ventilating and Bleed Valve Type 591

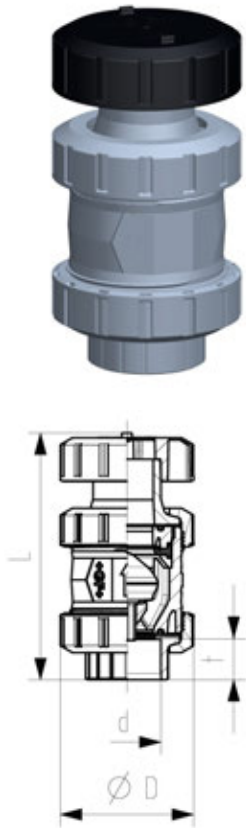

**Ventilating and bleed valve**  
**Type 591 ABS**  
**With solvent cement sockets Inch BS**

**Model:**

- With protection cap up to DN50 made from PP-GF, DN65-100 made from POM
- Floater made of PP-H
- Designed for easy installation and removal
- Compact installation length

Size (inch)	DN (mm)	PN (bar)	EPDM Code	Weight (kg)	D (mm)	L (mm)	t (mm)
3/8	10	10	169 591 101	0.107	50	126	16
1/2	15	10	169 591 102	0.107	50	127	18
3/4	20	10	169 591 103	0.213	58	142	21
1	25	10	169 591 104	0.244	68	155	24
1 1/4	32	10	169 591 105	0.422	84	177	29
1 1/2	40	10	169 591 106	0.639	97	195	30
2	50	10	169 591 107	1.106	124	227	36
	65	10	169 591 008	2.420	166	256	45
3	80	10	169 591 109	3.890	200	275	51
4	100	10	169 591 110	6.140	238	318	64

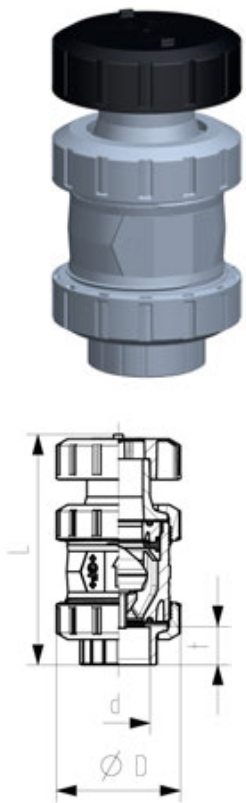

**Ventilating and bleed valve**  
**Type 591 ABS**  
**With solvent cement sockets metric**

**Model:**

- With protection cap up to DN50 made from PP-GF, DN65-100 made from POM
- Floater made of PP-H
- Designed for easy installation and removal
- Compact installation length

d (mm)	DN (mm)	PN (bar)	EPDM Code	Weight (kg)	D (mm)	L (mm)	t (mm)
16	10	10	169 591 001	0.107	50	126	14
20	15	10	169 591 002	0.107	50	127	16
25	20	10	169 591 003	0.213	58	142	18
32	25	10	169 591 004	0.254	68	155	22
40	32	10	169 591 005	0.432	84	177	26
50	40	10	169 591 006	0.629	97	195	31
63	50	10	169 591 007	1.096	124	227	38
75	65	10	169 591 008	2.420	166	256	45
90	80	10	169 591 009	3.870	200	275	52
110	100	10	169 591 010	6.240	238	318	64

# Ventilating Valve Type 595



## Ventilating valve type 595 ABS With solvent cement sockets Inch BS

### Model:

- With protection cap up to DN50 made from PP-GF, DN65-100 made from POM
- Spring loaded, spring made of NIMONIC 90, HALAR coated
- Spring available in other materials, see spare parts
- Designed for easy installation and removal
- Compact installation length

Size (inch)	DN (mm)	PN (bar)	EPDM Code	Weight (kg)	D (mm)	L (mm)	t (mm)
3/8	10	10	169 595 101	0.107	50	126	16
1/2	15	10	169 595 102	0.107	50	127	18
3/4	20	10	169 595 103	0.213	58	142	21
1	25	10	169 595 104	0.244	68	155	24
1 1/4	32	10	169 595 105	0.422	84	177	29
1 1/2	40	10	169 595 106	0.639	97	195	30
2	50	10	169 595 107	1.106	124	227	36
	65	10	169 595 008	2.420	166	256	45
3	80	10	169 595 109	3.890	200	275	51
4	100	10	169 595 110	6.140	238	318	64

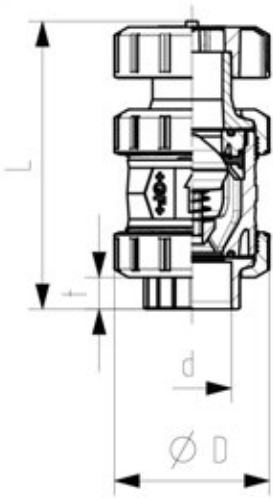

## Ventilating valve type 595 ABS With solvent cement sockets metric

### Model:

- With protection cap up to DN50 made from PP-GF, DN65-100 made from POM
- Spring loaded, spring made of NIMONIC 90, HALAR coated
- Spring available in other materials, see spare parts
- Designed for easy installation and removal
- Compact installation length

d (mm)	DN (mm)	PN (bar)	EPDM Code	Weight (kg)	D (mm)	L (mm)	t (mm)
16	10	10	169 595 001	0.107	50	126	14
20	15	10	169 595 002	0.107	50	127	16
25	20	10	169 595 003	0.213	58	142	18
32	25	10	169 595 004	0.254	68	155	22
40	32	10	169 595 005	0.432	84	177	26
50	40	10	169 595 006	0.629	97	195	31
63	50	10	169 595 007	1.096	124	227	38
75	65	10	169 595 008	2.420	166	256	45
90	80	10	169 595 009	3.870	200	275	52
110	100	10	169 595 010	6.240	238	318	64

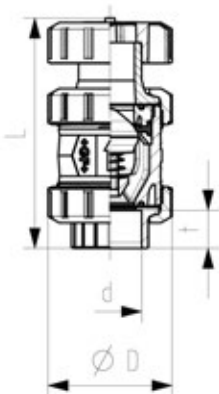

# Strainers

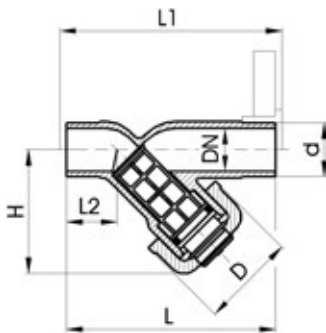

## Line strainer type 305 ABS With solvent cement spigots metric

### Model:

- Protects valves, pumps, etc. from becoming soiled
- Easy dismantling for cleaning the screens
- Overall length EN 558
- Cylindrical screen must be ordered separately
- Screen in stainless steel operable temperature range up -40°C to +60°C
- Screen in PVC-U operable temperature range up 0°C to +60°C

d (mm)	DN (mm)	PN (bar)	EPDM Code	Weight (kg)	D (mm)	H (mm)	L (mm)	L1 (mm)	L2 (mm)
20	15	10	<b>169 305 302</b>	0.081	48	65	124	130	28
25	20	10	<b>169 305 303</b>	0.120	54	76	144	150	37
32	25	10	<b>169 305 304</b>	0.180	62	90	154	160	37
40	32	10	<b>169 305 305</b>	0.284	71	104	174	180	44
50	40	10	<b>169 305 306</b>	0.484	88	124	194	200	48
63	50	10	<b>169 305 307</b>	0.780	103	148	224	230	60



## Cylindrical screen type 305 PVC-U Screen perforations 0.5 mm

- For line strainers Type 305

d (mm)	Size (inch)	DN (mm)	kv-value ( $\Delta p=1$ bar) (L/min)	Code	Weight (kg)	D (mm)	L (mm)
20	¾	15	35	<b>161 305 339</b>	0.005	14	39
25	1	20	65	<b>161 305 389</b>	0.007	18	48
32	1 ¼	25	90	<b>161 305 439</b>	0.003	24	60
40	1 ½	32	155	<b>161 305 489</b>	0.004	30	71
50	2	40	225	<b>161 305 539</b>	0.007	38	87
63	2 ½	50	370	<b>161 305 589</b>	0.009	48	106
75	3	65	575	<b>161 305 639</b>	0.012	61	100
90	3 ½	80	955	<b>161 305 689</b>	0.016	73	118



## Cylindrical screen type 305 PVC-U Screen perforations 0.8 mm

- For line strainers Type 305

d (mm)	DN (mm)	kv-value ( $\Delta p=1$ bar) (L/min)	Code	Weight (kg)	D (mm)	L (mm)	closest inch (inch)
20	15	35	<b>161 305 338</b>	0.005	14	39	½
25	20	65	<b>161 305 388</b>	0.007	18	48	¾
32	25	90	<b>161 305 438</b>	0.003	24	60	1
40	32	155	<b>161 305 488</b>	0.004	30	71	1 ¼
50	40	225	<b>161 305 538</b>	0.006	38	87	1 ½
63	50	370	<b>161 305 588</b>	0.003	48	106	2
75	65	575	<b>161 305 638</b>	0.012	61	100	2 ½
90	80	955	<b>161 305 688</b>	0.015	73	118	3





**Cylindrical screen type 305 PVC-U**  
**Screen perforations 1.4 mm**

- For line strainers Type 305

d (mm)	DN (mm)	kv-value ( $\Delta p=1$ bar) (l/min)	Code	Weight (kg)	D (mm)	L (mm)	closest inch (inch)
20	15	35	<b>161 305 337</b>	0.003	14	39	½
25	20	65	<b>161 305 387</b>	0.003	18	48	¾
32	25	90	<b>161 305 437</b>	0.003	24	60	1
40	32	155	<b>161 305 487</b>	0.004	30	71	1 ¼
50	40	225	<b>161 305 537</b>	0.005	38	87	1 ½
63	50	370	<b>161 305 587</b>	0.008	48	106	2
75	65	575	<b>161 305 637</b>	0.011	61	100	2 ½
90	80	955	<b>161 305 687</b>	0.013	73	118	3



**Cylindrical screen type 305 PVC-U**  
**Screen perforations 2.2 mm**

- For line strainers Type 305

d (mm)	DN (mm)	kv-value ( $\Delta p=1$ bar) (l/min)	Code	Weight (kg)	D (mm)	L (mm)	closest inch (inch)
20	15	35	<b>161 305 336</b>	0.005	14	39	½
25	20	65	<b>161 305 386</b>	0.003	18	48	¾
32	25	90	<b>161 305 436</b>	0.003	24	60	1
40	32	155	<b>161 305 486</b>	0.003	30	71	1 ¼
50	40	225	<b>161 305 536</b>	0.005	38	87	1 ½
63	50	370	<b>161 305 586</b>	0.008	48	106	2
75	65	575	<b>161 305 636</b>	0.010	61	100	2 ½
90	80	955	<b>161 305 686</b>	0.013	73	118	3



**Screen stainless steel**  
**Screen perforation 0.5 mm**

**Model:**

- Stainless Steel A4 Quality (AISI 316)
- For line strainers Type 305

d (mm)	DN (mm)	kv-value ( $\Delta p=1$ bar) (l/min)	Code	Weight (kg)	D (mm)	L (mm)
20	15	35	<b>161 486 100</b>	0.002	14	39
25	20	60	<b>161 486 101</b>	0.004	18	48
32	25	85	<b>161 486 102</b>	0.006	24	60
40	32	130	<b>161 486 103</b>	0.008	30	71
50	40	200	<b>161 486 104</b>	0.014	38	87
63	50	330	<b>161 486 105</b>	0.019	48	106
75	65	460	<b>161 486 106</b>	0.026	61	100
90	80	665	<b>161 486 107</b>	0.034	73	118



# Variable Area Flow Meters



Variable area flow meters  
 Float in PVDF without magnet  
 With solvent cement sockets ABS BS Inch

d (inch)	DN (mm)	Scale range (L/min)	Taper tube in Polyamid O-rings in EPDM Code	Weight (kg)	Taper tube in Polysulfone O-rings in EPDM Code	L1 (mm)	D (mm)	L (mm)	L2 (mm)	G (inch)
1	25	50 - 500	<b>198 802 814</b>	0.450	<b>198 802 815</b>	341	58	385	335	1 ½
1	25	100 - 1000	<b>198 802 816</b>	0.450	<b>198 802 817</b>	341	58	385	335	1 ½
1 ½	40	300 - 3000	<b>198 802 818</b>	0.900	<b>198 802 819</b>	341	83	403	335	2 ¼
1 ½	40	600 - 6000	<b>198 802 820</b>	0.900	<b>198 802 821</b>	341	83	403	335	2 ¼
2	50	1000 - 10000	<b>198 802 822</b>	1.370	<b>198 802 823</b>	341	101	417	335	2 ¼
2	50	1500 - 15000	<b>198 802 824</b>	1.370	<b>198 802 825</b>	341	101	417	335	2 ¼

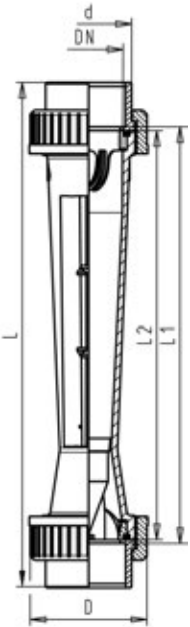



**Variable area flow meters**  
**Float in PVDF with magnet**  
**With solvent cement sockets ABS BS Inch**

**Model:**

- Suitable limit switches see accessories for variable area flow meters

Scale range (L/min)	d (inch)	DN (mm)	Taper tube in Polyamid O-rings in EPDM Code	Taper tube in Polysulfone O-rings in EPDM Code	Weight (kg)	D (mm)	L (mm)	L1 (mm)	L2 (mm)	G (inch)
50 - 500	1	25	<b>198 802 826</b>	<b>198 802 827</b>	0.480	58	385	341	335	1 ½
100 - 1000	1	25	<b>198 802 828</b>	<b>198 802 829</b>	0.480	58	385	341	335	1 ½
300 - 3000	1 ½	40	<b>198 802 830</b>	<b>198 802 831</b>	0.950	83	403	341	335	2 ¼
600 - 6000	1 ½	40	<b>198 802 832</b>	<b>198 802 833</b>	0.950	83	403	341	335	2 ¼
1000 - 10000	2	50	<b>198 802 834</b>	<b>198 802 835</b>	1.500	101	417	341	335	2 ¾
1500 - 15000	2	50	<b>198 802 836</b>	<b>198 802 837</b>	1.500	101	417	341	335	2 ¾

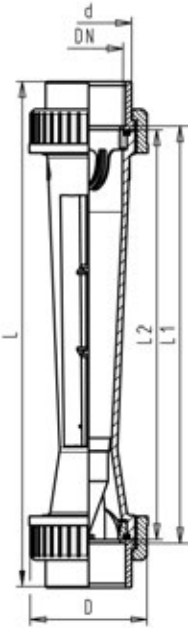



**Variable area flow meters**  
**Float in PVDF without magnet**  
**With solvent cement sockets ABS metric**

Scale range (l/min)	DN (mm)	d (mm)	Taper tube in Polyamid O-rings in EPDM Code	Weight (kg)	Taper tube in Polysulfone O-rings in EPDM Code	D (mm)	L (mm)	L1 (mm)	L2 (mm)	G (inch)
50 - 500	25	32	<b>198 807 120</b>	0.010	<b>198 807 126</b>	58	385	341	335	1 ½
100 - 1000	25	32	<b>198 807 121</b>	0.544	<b>198 807 127</b>	58	385	341	335	1 ½
300 - 3000	40	50	<b>198 807 122</b>	0.900	<b>198 807 128</b>	83	403	341	335	2 ¼
600 - 6000	40	50	<b>198 807 123</b>	0.900	<b>198 807 129</b>	83	403	341	335	2 ¼
1000 - 10000	50	63	<b>198 807 124</b>	1.370	<b>198 807 130</b>	101	417	341	335	2 ¾
1500 - 15000	50	63	<b>198 807 125</b>	1.370	<b>198 807 131</b>	101	417	341	335	2 ¾

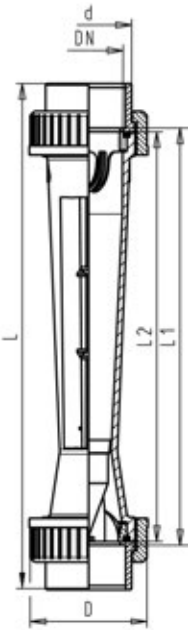



**Variable area flow meters**  
**Float in PVDF with magnet**  
**With solvent cement sockets ABS metric**

**Model:**

- Suitable limit switches see accessories for variable area flow meters

Scale range (L/min)	d (mm)	DN (mm)	Taper tube in Polyamid O-rings in EPDM Code	Weight (kg)	Taper tube in Polysulfone O-rings in EPDM Code	D (mm)	L (mm)	L1 (mm)	L2 (mm)	G (inch)
50 - 500	32	25	<b>198 807 132</b>	0.460	<b>198 807 138</b>	58	385	341	335	1 ½
100 - 1000	32	25	<b>198 807 133</b>	0.460	<b>198 807 139</b>	58	385	341	335	1 ½
300 - 3000	50	40	<b>198 807 134</b>	0.900	<b>198 807 140</b>	83	403	341	335	2 ¼
600 - 6000	50	40	<b>198 807 135</b>	0.900	<b>198 807 141</b>	83	403	341	335	2 ¼
1000 - 10000	63	50	<b>198 807 136</b>	1.758	<b>198 807 142</b>	101	417	341	335	2 ¾
1500 - 15000	63	50	<b>198 807 137</b>	1.758	<b>198 807 143</b>	101	417	341	335	2 ¾

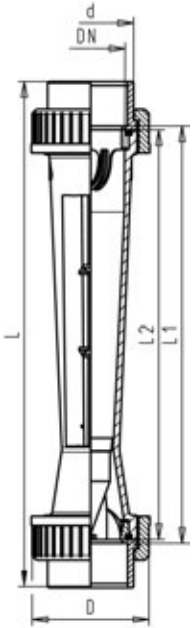

**Short Version**  
**Float in PVDF without magnet**  
**With solvent cement sockets ABS BS Inch**

**Model:**

- Union nuts and valve ends in other materials on request

Type	Scale range (L/min)	d (inch)	DN (mm)	Taper tube in Polysulfone O-rings in EPDM Code	Weight (kg)	D (mm)	L (mm)	L1 (mm)	L2 (mm)
------	------------------------	-------------	------------	---	----------------	-----------	-----------	------------	------------

SK50	2.5 - 25	3/8	10	<b>198 807 040</b>	0.180	35	199	171	165
SK51	5 - 50	3/8	10	<b>198 807 041</b>	0.180	35	199	171	165
SK52	10 - 100	3/8	10	<b>198 807 042</b>	0.180	35	199	171	165
SK60	8 - 80	1/2	15	<b>198 807 043</b>	0.250	43	223	191	185
SK61	15 - 150	1/2	15	<b>198 807 044</b>	0.250	43	223	191	185
SK62	20 - 200	1/2	15	<b>198 807 045</b>	0.120	43	223	191	185
SK70	15 - 150	1	25	<b>198 807 046</b>	0.440	60	250	206	200
SK71	30 - 300	1	25	<b>198 807 047</b>	5.000	60	250	206	200
SK72	50 - 500	1	25	<b>198 807 048</b>	0.280	60	250	206	200
SK73	100 - 1000	1	25	<b>198 807 049</b>	0.440	60	250	206	200



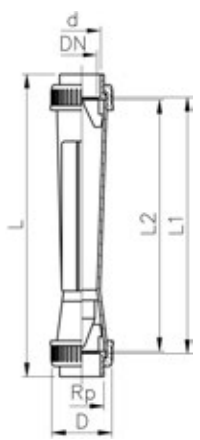

**Short Version**  
**Float in PVDF with magnet**  
**With solvent cement sockets ABS BS Inch**

**Model:**

- Suitable limit switches see accessories for variable area flow meters
- Union nuts and valve ends in other materials on request

Type	Scale range (l/min)	d (inch)	DN (mm)	Taper tube in Polysulfone O-rings in EPDM Code	Weight (kg)	D (mm)	L (mm)	L1 (mm)	L2 (mm)
SK500	2.5 - 25	3/8	10	<b>198 807 050</b>	0.180	35	199	171	165
SK510	5 - 50	3/8	10	<b>198 807 051</b>	0.180	35	199	171	165
SK520	10 - 100	3/8	10	<b>198 807 052</b>	0.180	35	199	171	165
SK600	8 - 80	1/2	15	<b>198 807 053</b>	0.170	43	223	191	185
SK610	15 - 150	1/2	15	<b>198 807 054</b>	0.250	43	223	191	185
SK620	20 - 200	1/2	15	<b>198 807 055</b>	0.170	43	223	191	185
SK700	15 - 150	1	25	<b>198 807 056</b>	0.440	60	250	206	200
SK710	30 - 300	1	25	<b>198 807 057</b>	0.350	60	250	206	200
SK720	50 - 500	1	25	<b>198 807 058</b>	0.340	60	250	206	200
SK730	100 - 1000	1	25	<b>198 807 059</b>	0.340	60	250	206	200

**Short Version**  
**Float in PVDF without magnet**  
**With solvent cement sockets ABS metric**

**Model:**

- Union nuts and valve ends in other materials on request

Type	Scale range (L/min)	d (mm)	DN (mm)	Taper tube in Polysulfone O-rings in EPDM Code	Weight (kg)	D (mm)	L (mm)	L1 (mm)	L2 (mm)
------	------------------------	-----------	------------	---	----------------	-----------	-----------	------------	------------

SK50	2.5 - 25	16	10	<b>198 807 144</b>	0.180	35	199	171	165
SK51	5 - 50	16	10	<b>198 807 145</b>	5.000	35	199	171	165
SK52	10 - 100	16	10	<b>198 807 146</b>	0.180	35	199	171	165
SK60	8 - 80	20	15	<b>198 807 147</b>	0.250	43	223	191	185
SK61	15 - 150	20	15	<b>198 807 148</b>	0.250	43	223	191	185
SK62	20 - 200	20	15	<b>198 807 149</b>	0.250	43	223	191	185
SK70	15 - 150	32	25	<b>198 807 150</b>	5.000	60	250	206	200
SK71	30 - 300	32	25	<b>198 807 151</b>	0.440	60	250	206	200
SK72	50 - 500	32	25	<b>198 807 152</b>	0.440	60	250	206	200
SK73	100 - 1000	32	25	<b>198 807 153</b>	5.000	60	250	206	200





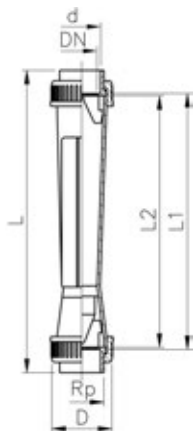

**Short Version**  
**Float in PVDF with magnet**  
**With solvent cement sockets ABS metric**

**Model:**

- Suitable limit switches see accessories for variable area flow meters
- Union nuts and valve ends in other materials on request

Type	Scale range (l/min)	d (mm)	DN (mm)	Taper tube in Polysulfone O-rings in EPDM Code	Weight (kg)	D (mm)	L (mm)	L1 (mm)	L2 (mm)
SK500	2.5 - 25	16	10	<b>198 807 154</b>	0.180	35	199	171	165
SK510	5 - 50	16	10	<b>198 807 155</b>	0.180	35	199	171	165
SK520	10 - 100	16	10	<b>198 807 156</b>	0.180	35	199	171	165
SK600	8 - 80	20	15	<b>198 807 157</b>	0.260	43	223	191	185
SK610	15 - 150	20	15	<b>198 807 158</b>	0.260	43	223	191	185
SK620	20 - 200	20	15	<b>198 807 159</b>	0.260	43	223	191	185
SK700	15 - 150	32	25	<b>198 807 160</b>	0.444	60	250	206	200
SK710	30 - 300	32	25	<b>198 807 161</b>	0.444	60	250	206	200
SK720	50 - 500	32	25	<b>198 807 162</b>	0.444	60	250	206	200
SK730	100 - 1000	32	25	<b>198 807 163</b>	0.440	60	250	206	200

**Accessories**  
**4-20 mA sensor**  
**For type 335 and type 350**

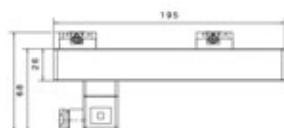

Type	d (mm)	DN (mm)	Corresponds to water scale (l/h)	Code	Weight (kg)
GK 15	32	25	50-500	<b>198 335 962</b>	0.150
GK 15	32	25	100-1000	<b>198 335 963</b>	0.150
GK 15	40	32	150-1500	<b>198 335 964</b>	0.150
GK 15	40	32	250-2500	<b>198 335 965</b>	0.150
GK 15	50	40	200-2000	<b>198 335 966</b>	0.150
GK 15	50	40	300-3000	<b>198 335 967</b>	0.150
GK 15	50	40	600-6000	<b>198 335 968</b>	0.150
GK 15	63	50	600-6000	<b>198 335 969</b>	0.150
GK 15	63	50	1000-10000	<b>198 335 991</b>	0.150
GK 15	63	50	1500-15000	<b>198 335 992</b>	0.120
GK 15	75	65	2000-20000	<b>198 335 993</b>	0.150
GK 15	75	65	3000-30000	<b>198 335 994</b>	0.150
GK 15	75	65	8000-60000	<b>198 335 995</b>	0.150

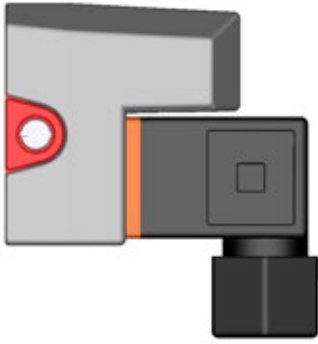

Limit contacts GK10/GK11 For type 335/350 and short version

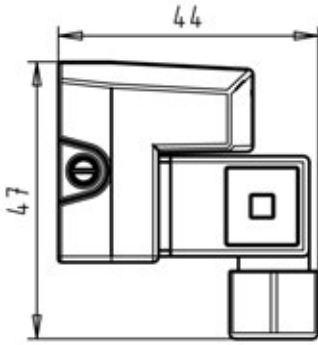

Type	Code	Weight (kg)
GK10 (min.)	<b>198 335 998</b>	0.035
GK11 (max.)	<b>198 335 999</b>	0.034





	<p>Brackets</p>	<p>106</p>
	<p>Solvent Cementing Tools</p>	<p>109</p>
	<p>Backing Flanges</p>	<p>110</p>
	<p>Gaskets</p>	<p>114</p>

# Brackets

## KLIP-IT pipe clip type 061 PP BS



### Model:

- Material: clip and safety clip PP black, UV resistant
- 3/8" - 2": height designed for Ball Valve Type 546 and 543
- **Minimum order quantity: standard packaging SP**

	d (inch)	Code	Weight (kg)	D (mm)	D1 (mm)	H (mm)	H1 (mm)	H2 (mm)	H3 (mm)	L1 (mm)	L2 (mm)	SC
*	¼	167 061 054	0.003	5	8	21	10	6	12	11	14	M5
*	⅜	167 061 085	0.006	6	10	27	10	6	16	14	17	M5
*	½	167 061 086	0.009	6	10	27	10	6	16	17	19	M5
*	¾	167 061 087	0.007	6	10	30	10	6	16	19	22	M5
*	1	167 061 088	0.012	6	10	36	10	6	16	24	27	M5
	1 ¼	167 061 089	0.025	7	14	44	10	7	22	34	34	M6
	1 ½	167 061 090	0.032	7	14	51	10	7	22	37	37	M6
	2	167 061 091	0.052	9	17	64	10	10	25	45	45	M8
	2 ½	167 061 112	0.062	9	17	58	10	10	25	52	52	M8
	3	167 061 013	0.092	9	17	65	10	10	28	65	65	M8
	4	167 061 114	0.114	9	17	81	10	10	28	79	79	M8
	5	167 061 016	0.224	9	17	110	10	10	32	98	98	M8

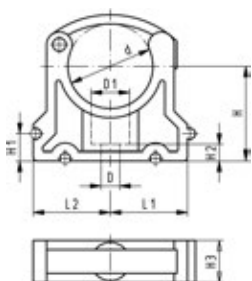

## KLIP-IT pipe clip type 061 PP metric



### Model:

- Material: clip and safety clip PP black, UV resistant
- d16 - d63: Height designed for Ball Valve Type 546 and 543
- **Minimum order quantity: standard packagings SP**

	d (mm)	Code	Weight (kg)	D (mm)	D1 (mm)	L1 (mm)	L2 (mm)	H (mm)	H1 (mm)	H2 (mm)	H3 (mm)	SC
*	10	167 061 003	0.003	5	8	11	14	20	10	6	12	M4
*	12	167 061 004	0.003	5	8	11	14	21	10	6	12	M5
*	16	167 061 035	0.007	6	11	14	17	27	10	6	16	M5
*	20	167 061 036	0.007	6	11	17	19	27	10	6	16	M5
*	25	167 061 037	0.009	6	11	19	22	30	10	6	16	M5
*	32	167 061 038	0.012	6	11	24	27	36	10	6	16	M5
	40	167 061 039	0.027	7	14	34	34	44	10	7	22	M6
	50	167 061 040	0.031	7	14	37	37	51	10	7	22	M6
	63	167 061 041	0.052	9	17	45	45	64	10	10	25	M8
	75	167 061 012	0.057	9	17	52	52	58	10	10	25	M8
	90	167 061 013	0.092	9	17	65	65	65	10	10	28	M8
	110	167 061 014	0.117	9	17	79	79	75	10	10	28	M8
	125	167 061 015	0.180	9	17	88	88	90	10	10	32	M8
	140	167 061 016	0.224	9	17	98	98	110	10	10	32	M8
	160	167 061 017	0.242	9	17	109	109	108	10	10	32	M8

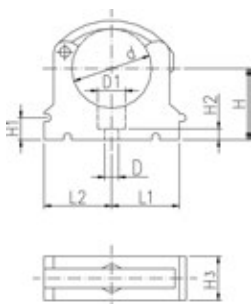



### KLIP-IT spacer type 061 PP

**Model:**

- For pipe clips Type 061, PP black, UV resistant
- **Minimum order quantity: standard packaging SP**

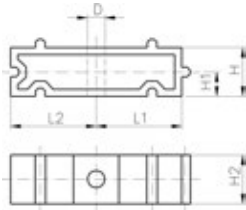

d (mm)	Inch (inch)	Code	Weight (kg)	D (mm)	L1 (mm)	L2 (mm)	H (mm)	H1 (mm)	H2 (mm)	SC
10 - 12	1/8 - 1/4	<b>167 061 153</b>	0.003	5	11	14	20	10	12	M4
16	3/8	<b>167 061 155</b>	0.005	6	14	17	20	10	16	M5
20	1/2	<b>167 061 156</b>	0.005	6	17	19	20	10	16	M5
25	3/4	<b>167 061 157</b>	0.007	6	19	22	20	10	16	M5
32	1	<b>167 061 158</b>	0.006	6	24	27	20	10	16	M5
40	1 1/4	<b>167 061 159</b>	0.015	7	34	34	20	10	22	M6
50	1 1/2	<b>167 061 160</b>	0.017	7	37	37	20	10	22	M6
63	2	<b>167 061 161</b>	0.020	9	45	45	20	10	25	M8
75	2 1/2	<b>167 061 162</b>	0.027	9	52	52	20	10	25	M8

### KLIP-IT pipe clip type 061 PE metric

**Model:**

- Material: Clip PE and safety clip PP black, bolts galvanized
- **Minimum order quantity: standard packaging SP**
- Height not designed for ball valve 546 and 543. Please use spacer 73 06 11.

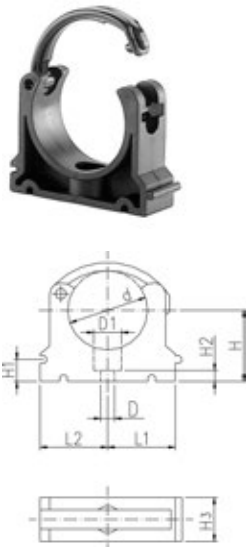

d (mm)	Code	Weight (kg)	D (mm)	D1 (mm)	L1 (mm)	L2 (mm)	H (mm)	H1 (mm)	H2 (mm)	H3 (mm)	SC
* 10	<b>173 061 003</b>	0.003	5	8	11	14	20	10	6	12	M4
* 12	<b>173 061 004</b>	0.006	5	8	11	14	21	10	6	12	M5
* 16	<b>173 061 005</b>	0.006	6	11	14	17	23	10	6	16	M5
* 20	<b>173 061 006</b>	0.007	6	11	17	19	25	10	6	16	M5
* 25	<b>173 061 007</b>	0.009	6	11	19	22	28	10	6	16	M5
* 32	<b>173 061 008</b>	0.011	6	11	24	27	31	10	6	16	M5
40	<b>173 061 009</b>	0.026	7	14	34	34	35	10	7	22	M6
50	<b>173 061 010</b>	0.028	7	14	37	37	40	10	7	22	M6
63	<b>173 061 011</b>	0.047	9	17	45	45	52	10	10	25	M8
75	<b>173 061 012</b>	0.061	9	17	52	52	58	10	10	25	M8
90	<b>173 061 013</b>	0.098	9	17	65	65	65	10	10	28	M8
110	<b>173 061 014</b>	0.125	9	17	79	79	75	10	10	28	M8
125	<b>173 061 015</b>	0.194	9	17	88	88	90	10	10	32	M8
140	<b>173 061 016</b>	0.243	9	17	98	98	110	10	10	32	M8
160	<b>173 061 017</b>	0.254	9	17	109	109	108	10	10	32	M8

### KLIP-IT spacer type 061 PE

**Model:**

- **Minimum order quantity: standard packaging SP**
- For pipe clips Type 061, PE black, UV resistant

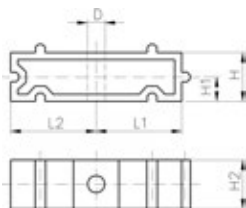

d (mm)	Inch (inch)	Code	Weight (kg)	D (mm)	L1 (mm)	L2 (mm)	H (mm)	H1 (mm)	H2 (mm)	SC
16	3/8	<b>173 061 155</b>	0.005	6	14	17	20	10	16	M5
20	1/2	<b>173 061 156</b>	0.005	6	17	19	20	10	16	M5
25	3/4	<b>173 061 157</b>	0.006	6	19	22	20	10	16	M5
32	1	<b>173 061 158</b>	0.008	6	24	27	20	10	16	M5
40	1 1/4	<b>173 061 159</b>	0.016	7	34	34	20	10	22	M6
50	1 1/2	<b>173 061 160</b>	0.017	7	37	37	20	10	22	M6
63	2	<b>173 061 161</b>	0.025	9	45	45	20	10	25	M8
75	2 1/2	<b>173 061 162</b>	0.027	9	52	52	20	10	25	M8
90	3	<b>173 061 163</b>	0.040	9	65	65	20	10	28	M8

table continued on the next page

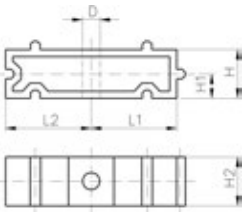

d (mm)	Inch (inch)	Code	Weight (kg)	D (mm)	L1 (mm)	L2 (mm)	H (mm)	H1 (mm)	H2 (mm)	SC
110	4	173 061 164	0.050	9	79	79	20	10	28	M8
125	4 1/2	173 061 165	0.059	9	88	88	20	10	32	M8
140	5	173 061 166	0.065	9	98	98	20	10	32	M8
160	6	173 061 167	0.078	9	109	109	20	10	32	M8

### Pipe clip type 060 PP BS

#### Model:

- Material: clip and safety clip PP black, UV resistant
- Accidental opening of the safety clip is not possible
- **Minimum order quantity: standard packaging SP or gross packaging GP**
- Clip and safety clip are not assembled in the packaging

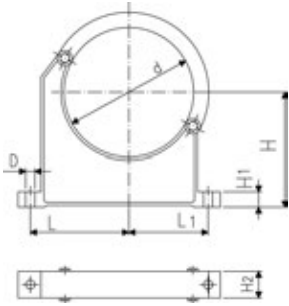

d (inch)	Code	Weight (kg)	D (mm)	L (mm)	L1 (mm)	H (mm)	H1 (mm)	H2 (mm)	SC
3	167 060 038	0.144	9	89	71	105	15	33	M 8
4	167 060 064	0.160	9	100	82	120	15	33	M 8
5	167 060 041	0.260	11	121	98	130	20	35	M 10
6	167 060 067	0.302	11	136	111	148	25	35	M 10
8	167 060 070	0.514	13	165	132	175	25	39	M 12

### Pipe clip type 060 PP metric

#### Model:

- Material: clip and safety clip PP black, UV resistant
- **Minimum order quantity: standard packaging SP or gross packaging GP**
- Accidental opening of the safety clip is not possible
- Clip and safety clip are not assembled in the packaging
- Pipes with flanges can be installed directly

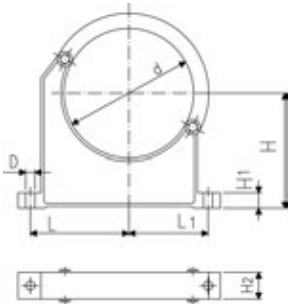

d (mm)	Code	Weight (kg)	D (mm)	L (mm)	L1 (mm)	H (mm)	H1 (mm)	H2 (mm)	SC
90	167 060 038	0.144	9	89	71	105	15	33	M 8
110	167 060 039	0.158	9	94	80	115	15	33	M 8
125	167 060 040	0.249	11	116	91	130	20	35	M10
140	167 060 041	0.260	11	121	98	130	20	35	M10
160	167 060 042	0.296	11	131	107	148	20	35	M10
180	167 060 043	0.327	11	143	115	163	20	35	M10
200	167 060 019	0.539	13	152	120	175	25	39	M12
225	167 060 020	0.178	13	165	132	175	25	39	M12
250	167 060 021	0.657	13	183	143	200	25	39	M12
280	167 060 022	0.212	13	198	156	200	25	39	M12
315	167 060 023	0.805	13	219	172	225	25	39	M12
355	167 060 024	1.251	17	275	209	258	30	50	M16
400	167 060 025	1.031	17	300	228	288	30	50	M16



# Solvent Cementing Tools



## Tangit ABS solvent cement

Code	Weight (kg)	Description
<b>799 298 022</b>	0.750	Tin: 0.65 kg (net)



## Tangit PVC-U/PVC-C/ABS cleaner

### Model:

- For PVC-U, PVC-C, ABS
- 1 litre tin

Code	Weight (kg)
<b>799 298 010</b>	0.900



## PPC Plastic pipe cutter

For cutting plastic pipes d10 - d160

d-d (mm)	Article	Code	Weight (kg)	Closest inch (inch)
10 - 63	PPC 63, s max. = 7.2mm	<b>790 109 001</b>	0.865	1/8 - 2
50 - 110	PPC 110, s max. = 12.7mm	<b>790 109 002</b>	1.624	1 1/2 - 4
110 - 160	PPC 160, s max. = 19.0mm	<b>790 109 003</b>	2.212	4 - 6



## Chamfering tool

- Chamfering tool with 15° bevel for plastic pipes (PVC, ABS, PP, PB, PE). Coated prism surface suitable for clean room applications. Fast and reliable adjustment to different pipe diameters and wall thickness. Coated prism surface suitable for clean room applications. Fast and reliable adjustment to the different pipe diameters and wall thickness.

Code	Weight (kg)	d-d (mm)
<b>790 309 003</b>	1.024	16 - 200
<b>790 309 004</b>	2.548	63 - 400



### Cap for cement

- Cap prevents the evaporation of the solvent whilst using the Tangit cement

Code	Weight (kg)
<b>799 298 028</b>	0.030



### Round brush

d-d (mm)		#	Code	Weight (kg)
6 - 10	4 mm (for Fittings 6-10mm)		<b>799 299 001</b>	0.004
12 - 32	8 mm (for Fittings 12-32mm)		<b>799 299 002</b>	0.006



### Flat brush

d-d (mm)		#	Code	Weight (kg)
40 - 63	25x3 mm (for Fittings 40-63mm)		<b>799 299 003</b>	0.015
75 - 225	50x5 mm (for Fittings 75-225mm)		<b>799 299 004</b>	0.035
250 - 400	75x6 mm (for Fittings 250-400mm)		<b>799 299 005</b>	0.053

## Backing Flanges

### Backing Flanges, Steel

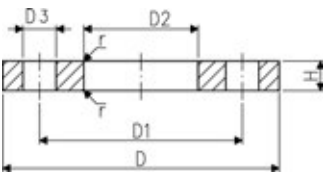

#### Backing Flange, Galvanised Steel for Socket Systems

##### Model:

- Connecting dimensions: BS10:1962
- Galvanised steel, suitable for laying underground
- Bolt circle Table D & E

AL: number of holes

\* Table D

\*\* Table E

d	d	DN	PN	Code	Weight	D	D1	D2	D3	H	AL	SC
(mm)	(inch)	(mm)	(bar)		(kg)	(mm)	(mm)	(mm)	(mm)	(mm)		
20	¾	15	16	<b>724 701 406</b>	0.250	96	67	28	15	7	4	M12x55
25	¾	20	16	<b>724 701 407</b>	0.300	102	73	34	15	7	4	M12x60
32	1	25	16	<b>724 701 408</b>	0.380	115	83	42	15	7	4	M12x60
40	1 ¼	32	16	<b>724 701 409</b>	0.750	121	88	51	15	8	4	M12x70
50	1 ½	40	16	<b>724 701 410</b>	0.880	134	99	62	15	8	4	M12x75
63	2	50	16	<b>724 701 411</b>	1.000	153	115	78	18	8	4	M16x80
75	2 ½	65	16	<b>724 701 412</b>	1.200	165	127	92	18	8	4	M16x85
90	3	80	16	<b>724 701 413</b>	1.000	184	146	110	18	8	4	M16x90
110		100	16	<b>724 703 414</b>	1.600	216	178	133	18	8	8	M16x95
		4 100	16	<b>724 701 414</b>	1.620	216	178	138	18	8	4	M16x95
		4 100	16	<b>724 701 415</b>	1.620	216	178	138	18	8	8	M16x95
140	5	125	16	<b>724 701 416</b>	2.250	254	210	167	18	8	8	M16x110
		6 160	16	<b>724 701 417</b>	2.500	280	235	200	22	8	8	M20x120
225	8	200	6	<b>724 701 419</b>	3.000	337	292	250	22	8	8	M20x150

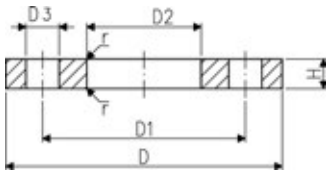

### Backing Flange, Galvanised Steel for Socket Systems

**Model:**

- Galvanised steel, suitable for laying underground
- Connecting dimension: ISO 7005, EN 1092, BS 4504, DIN 2501
- Bolt circle PN10/16

AL: number of holes

\*Bolt circle PN16

d (mm)	d (inch)	DN (mm)	PN (bar)	Code	Weight (kg)	D (mm)	D1 (mm)	D2 (mm)	D3 (mm)	H (mm)	AL	SC
20	¾	15	16	<b>724 701 606</b>	0.220	95	65	28	14	7	4	M16x80
25	¾	20	16	<b>724 701 607</b>	0.320	105	75	34	14	7	4	M12x60
32	1	25	16	<b>724 701 608</b>	0.410	115	85	42	14	7	4	M12x60
40	1 ¼	32	16	<b>724 701 609</b>	0.820	140	100	51	18	8	4	M16x70
50	1 ½	40	16	<b>724 701 610</b>	1.040	150	110	62	18	8	4	M16x75
63	2	50	16	<b>724 701 611</b>	1.220	165	125	78	18	8	4	M16x80
75	2 ½	65	16	<b>724 701 612</b>	1.440	185	145	92	18	8	4	M16x85
90	3	80	16	<b>724 701 613</b>	1.530	200	160	110	18	8	4	M16x90
110		100	16	<b>724 700 014</b>	1.840	220	180	133	18	8	8	M16x95
	4	100	16	<b>724 701 615</b>	1.620	220	180	138	18	8	8	M16x95
140	5	125	16	<b>724 701 616</b>	2.250	250	210	167	18	8	8	M16x110
	6	150	16	<b>724 701 617</b>	2.510	285	240	200	22	8	8	M20x120
225	8	200	6	<b>724 701 720</b>	3.000	340	295	250	22	8	12	M20x150

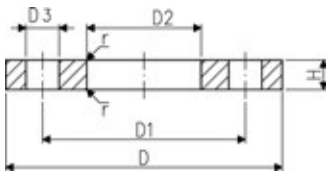

### Backing Flange, Galvanised Steel for Socket Systems

**Model:**

- Galvanised steel, suitable for laying underground
- Connecting dimension: ANSI/ASME B 16.5 class 150, ASTM D 4024, BS 1560, BS EN 1759

AL: number of holes

d (mm)	d (inch)	DN (mm)	PN (bar)	Code	Weight (kg)	D (mm)	D1 (mm)	D2 (mm)	D3 (mm)	H (mm)	AL	SC
20	¾	15	16	<b>724 701 806</b>	0.241	89	60	28	16	7	4	M12x55
25	¾	20	16	<b>724 701 807</b>	0.271	98	70	34	16	7	4	M12x60
32	1	25	16	<b>724 701 808</b>	0.359	108	79	42	16	7	4	M12x60
40	1 ¼	32	16	<b>724 701 809</b>	0.480	117	89	51	16	8	4	M12x70
50	1 ½	40	16	<b>724 701 810</b>	0.396	127	98	62	16	8	4	M12x75
63	2	50	16	<b>724 701 811</b>	0.677	152	121	78	19	8	4	M16x80
75	2 ½	65	16	<b>724 701 812</b>	1.200	178	140	92	19	8	4	M16x85
90	3	80	16	<b>724 701 813</b>	0.999	190	152	110	19	8	4	M16x90
110		100	16	<b>724 703 814</b>	2.011	229	190	133	19	8	8	M16x95
	4	100	16	<b>724 701 815</b>	0.480	229	190	138	19	8	8	M16x95
140	5	125	16	<b>724 701 816</b>	2.000	254	216	167	22	8	8	M20x120
	6	150	16	<b>724 701 817</b>	1.917	279	241	200	22	8	8	M20x120
225	8	200	6	<b>724 701 820</b>	3.160	343	298	250	22	8	8	M20x150

# Backing flanges, PP-V

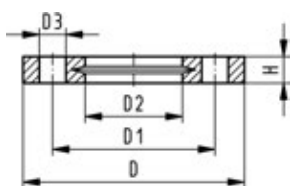

## Backing flange PP-V metric For socket systems metric

### Model:

- Connecting dimension: ISO 7005, EN 1092, BS 4504, DIN 2501
- **Bolt circle PN 10**
- Full-plastic flange PP-GF (30% glass-fiber reinforced)

<sup>1)</sup> Suitable for socket- and butt fusion systems

<sup>2)</sup> Not for BS

<sup>3)</sup> Combined version, metric-ANSI

AL: number of holes

	d	Size	DN	PN	Code	Weight	D	D1	D2	D3	H	AL	SC
	(mm)	(inch)	(mm)	(bar)		(kg)	(mm)	(mm)	(mm)	(mm)	(mm)		
1	20		15	16	<b>727 700 406</b>	0.093	95	65	28	14	16	4	M12
1	25		20	16	<b>727 700 407</b>	0.120	105	75	34	14	17	4	M12
1	32		25	16	<b>727 700 408</b>	0.151	115	85	42	14	18	4	M12
1	40		32	16	<b>727 700 409</b>	0.244	140	100	51	18	20	4	M12
1	50		40	16	<b>727 700 410</b>	0.297	150	110	62	18	22	4	M12
1	63		50	16	<b>727 700 411</b>	0.362	165	125	78	18	24	4	M12
1	75		65	16	<b>727 700 412</b>	0.487	185	145	92	18	26	4	M12
	90		80	16	<b>727 700 413</b>	0.550	200	160	110	18	27	8	M12
2	110		100	16	<b>727 700 414</b>	0.640	220	180	133	18	28	8	M12
	140		125	16	<b>727 700 416</b>	0.781	250	210	167	18	30	8	M12
2	160	6	150	16	<b>727 700 417</b>	1.050	285	240	190	22	32	8	M20
3	200	8	200	16	<b>727 700 419</b>	1.629	340	295	226	22	34	8	M20
3	225	8	200	16	<b>727 700 420</b>	1.400	340	295	250	22	34	8	M20
	250		250	16	<b>727 700 421</b>	2.229	395	350	277	22	38	12	M20
	280		250	16	<b>727 700 422</b>	1.651	395	350	310	22	38	12	M20
	315		300	16	<b>727 700 423</b>	2.461	445	400	348	22	42	12	M20
	355		350	10	<b>727 700 424</b>	3.000	515	460	388	22	46	16	M20
	400		400	10	<b>727 700 425</b>	5.135	574	515	442	26	50	16	M24

## Backing flange PP-V For socket systems Inch ANSI

### Model:

- Full-plastic flange PP-GF (30% glass-fiber reinforced)
- Connecting dimension: ANSI/ASME B 16.5 class 150, ASTM D 4024, BS 1560, BS EN 1759
- **Bolt circle class 150**

AL: number of holes

<sup>1)</sup> Suitable for socket- and butt fusion systems

<sup>2)</sup> Not for BS

<sup>3)</sup> Combined version, metric-ANSI

	d	Size	DN	PN	Code	Weight	D	D1	D2	D3	H	AL	SC
	(mm)	(inch)	(mm)	(bar)		(kg)	(mm)	(mm)	(mm)	(mm)	(mm)		
1	20	½	15	16	<b>727 701 406</b>	0.091	95	60	28	16	16	4	M12
1	25	¾	20	16	<b>727 701 407</b>	0.120	105	70	34	16	17	4	M12
1	32	1	25	16	<b>727 701 408</b>	0.147	115	79	42	16	18	4	M12
1	40	1 ¼	32	16	<b>727 701 409</b>	0.246	140	89	51	16	20	4	M12
1	50	1 ½	40	16	<b>727 701 410</b>	0.299	150	98	62	16	22	4	M12
1	63	2	50	16	<b>727 701 411</b>	0.361	165	121	78	19	24	4	M12
1	75	2 ½	65	16	<b>727 701 412</b>	0.492	185	140	92	19	26	4	M12
	90	3	80	16	<b>727 701 413</b>	0.605	200	152	110	19	27	4	M12
2	110	4	100	16	<b>727 701 414</b>	0.704	229	190	133	19	28	8	M12
2/3	160	6	150	16	<b>727 700 417</b>	1.050	285	240	190	22	32	8	M20

table continued on the next page

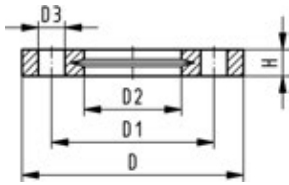

	d	Size	DN	PN	Code	Weight	D	D1	D2	D3	H	AL	SC
	(mm)	(inch)	(mm)	(bar)		(kg)	(mm)	(mm)	(mm)	(mm)	(mm)		
3	200	8	200	16	727 700 419	1.629	340	295	226	22	34	8	M20
3	225	8	200	16	727 700 420	1.400	340	295	250	22	34	8	M20
	280	10	250	16	727 701 422	1.838	406	362	310	26	38	12	M20
	315	12	300	16	727 701 423	3.482	483	432	348	26	42	12	M20

## Backing flanges, PP-Steel

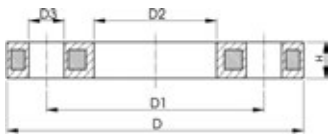

### Backing flange PP-Steel metric For socket systems metric and BS

#### Model:

- PP-GF (30% glass-fibre reinforced) with steel ring
- UV-resistant. Applicable for outside applications
- Connecting dimension: ISO 7005, EN 1092, BS 4504, DIN 2501
- Connecting dimension: ANSI/ASME B 16.5 class 150, ASTM D 4024, BS 1560, BS EN 1759
- Material: PP (30% glass-fibre reinforced) with steel ring
- **Bolt circle PN 10**
- **Bolt circle class 150**
- For socket systems metric and BS
- For Flange Adaptors BS/ANSI + metric

AL: number of holes

<sup>1)</sup> Suitable for socket -and butt fusion systems

<sup>2)</sup> Not for BS

<sup>3)</sup> Connecting dimension: ISO 2536. bolt circle acc. DN125. suitable for flange adaptor d125/ DN100

<sup>4)</sup> Connecting dimension: ISO 2536. bolt circle acc. DN225. suitable for flange adaptor d250/ DN250

<sup>5)</sup> Combined version, bolt circle metric - ANSI

Suitable for socket and butt fusion systems, no pictograph on flange.

	d	d	DN	PN	Code	Weight	D1	D3	D2	D	H	AL	SC
	(mm)	(inch)	(mm)	(bar)		(kg)	(mm)	(mm)	(mm)	(mm)	(mm)		
1	20		15	16	727 700 206	0.216	65	14	28	95	12	4	M12
1	25		20	16	727 700 207	0.279	75	14	34	105	12	4	M12
1	32		25	16	727 700 208	0.429	85	14	42	115	16	4	M12
1	40		32	16	727 700 209	0.621	100	18	51	140	16	4	M16
1	50		40	16	727 700 210	0.722	110	18	62	150	20	4	M16
1	63		50	16	727 700 211	1.084	125	18	78	165	20	4	M16
1	75		65	16	727 700 212	1.349	145	18	92	185	20	4	M16
	90		80	16	727 700 213	1.369	160	18	110	200	20	8	M16
2	110		100	16	727 700 214	1.522	180	18	133	220	20	8	M16
3	125		125	16	727 700 815	2.475	210	18	150	250	26	8	M16
	140		125	16	727 700 816	2.033	210	18	167	250	26	8	M16
2/5	160	6	150	16	727 700 817	3.167	241	22	190	285	26	8	M20
5	200	8	200	16	727 700 819	6.143	297	22	226	340	29	8	M20
5	225	8	200	16	727 700 820	4.448	297	22	250	340	29	8	M20
	250		250	16	727 700 821	7.179	350	22	277	395	32	12	M20
4	250		225	16	727 700 031	8.340	325	22	277	395	32	8	M20
	280		250	16	727 700 822	5.547	350	22	310	395	32	12	M20
	315		300	16	727 700 823	6.980	400	22	348	445	36	12	M20
	355		350	16	727 700 824	12.465	460	23	388	515	42	16	M20
	400		400	16	727 700 825	17.607	515	26	442	574	42	16	M24

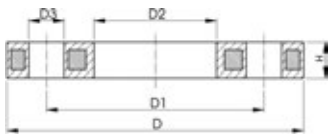

## Backing Flange PP-Steel For socket systems metric and Inch/BS/ANSI

### Model:

- Material: PP (30% glass-fibre reinforced) with steel ring
- Connecting dimension: ANSI/ASME B 16.5 class 150, ASTM D 4024, BS 1560, BS EN 1759
- **Bolt circle class 150**

<sup>1)</sup> Suitable for socket -and butt fusion systems

<sup>2)</sup> Not for BS

<sup>3)</sup> Combined version, bolt circle metric - ANSI

AL: number of holes

	d (inch)	d (mm)	DN (mm)	PN (bar)	Code	Weight (kg)	D (mm)	D1 (mm)	D2 (mm)	D3 (mm)	H (mm)	AL	SC
1	½	20	15	16	<b>727 701 206</b>	0.213	95	60	28	16	12	4	M12
1	¾	25	20	16	<b>727 701 207</b>	0.260	105	70	34	16	12	4	M12
1	1	32	25	16	<b>727 701 208</b>	0.416	115	79	42	16	16	4	M12
1	1 ¼	40	32	16	<b>727 701 209</b>	0.730	140	89	51	16	16	4	M16
1	1 ½	50	40	16	<b>727 701 210</b>	0.809	150	98	62	16	18	4	M16
1	2	63	50	16	<b>727 701 211</b>	0.866	165	121	78	19	18	4	M16
1	2 ½	75	65	16	<b>727 701 212</b>	1.117	185	140	92	19	18	4	M16
	3	90	80	16	<b>727 701 213</b>	1.492	200	152	110	19	20	4	M16
2	4	110	100	16	<b>727 701 214</b>	1.695	229	190	133	19	20	8	M16
2/3	6	160	150	16	<b>727 700 817</b>	3.167	285	241	190	22	26	8	M20
3	8	200	200	16	<b>727 700 819</b>	6.143	340	297	226	22	29	8	M20
3	8	225	200	16	<b>727 700 820</b>	4.448	340	297	250	22	29	8	M20

## Gaskets

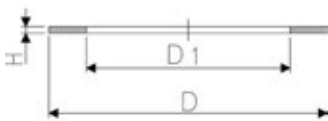

### Flat Gasket

#### Model:

- Hardness: 70° Shore **EPDM**, 75° Shore **FPM**
- For Flange Adaptors 21 79 01/21 80 01

d (mm)	DN (mm)	Inch (inch)	PN (bar)	EPDM Code	Weight (kg)	FPM Code	D (mm)	D1 (mm)	H (mm)
16	10	¾	10	<b>748 400 014</b>	0.002		27	16	2
20	15	½	10	<b>748 400 015</b>	0.002	<b>749 400 015</b>	32	20	2
25	20	¾	10	<b>748 400 016</b>	0.003	<b>749 400 016</b>	39	25	2
32	25	1	10	<b>748 400 017</b>	0.003	<b>749 400 017</b>	48	32	2
40	32	1 ¼	10	<b>748 400 018</b>	0.005	<b>749 400 018</b>	59	40	3
63	50	2	10	<b>748 400 020</b>	0.009	<b>749 400 020</b>	88	63	3
75	65	2 ½	10	<b>748 400 021</b>	0.012	<b>749 400 021</b>	104	75	3
90	80	3	10	<b>748 400 022</b>	0.017	<b>749 400 022</b>	123	90	3
110	100	4	10	<b>748 400 023</b>	0.033		148	110	4
140	125	5	10	<b>748 400 025</b>	0.054	<b>749 400 025</b>	186	140	4
160	150	6	10	<b>748 400 026</b>	0.063	<b>749 400 026</b>	211	160	4
225	200	8	6	<b>748 400 027</b>	0.103	<b>749 400 027</b>	272	220	5

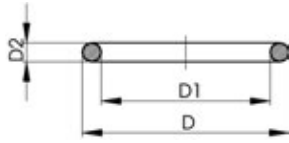

## O-Ring gasket

### Model:

- For unions and adaptor unions
- Hardness approx. 65° Shore
- EPDM minimum temperature -40°C
- FPM minimum temperature -15°C
- \* for unions PVC-U, PVC-C and ABS: 21 51 01, 21 51 11, 21 53 03, 21 53 08, 21 55 04, 21 55 13, 21 55 18, 23 51 01 and 29 51 01 only

	<b>d</b> (mm)	<b>DN</b> (mm)	<b>EPDM</b> <b>Code</b>	<b>Weight</b> (kg)	<b>FPM</b> <b>Code</b>	<b>D</b> (mm)	<b>D1</b> (mm)	<b>D2</b> (mm)	<b>closest</b> <b>inch</b> (inch)
	10 - 12	8	<b>748 410 004</b>	0.002	<b>749 410 004</b>	18	12	2.62	¼
	16	10	<b>748 410 005</b>	0.004	<b>749 410 005</b>	21	16	2.62	¾
	20	15	<b>748 410 006</b>	0.002	<b>749 410 006</b>	27	20	3.53	½
	25	20	<b>748 410 007</b>	0.002	<b>749 410 007</b>	35	28	3.53	¾
	32	25	<b>748 410 008</b>	0.003	<b>749 410 008</b>	40	33	3.53	1
	40	32	<b>748 410 009</b>	0.003	<b>749 410 009</b>	51	41	5.34	1 ¼
	50	40	<b>748 410 010</b>	0.004	<b>749 410 010</b>	58	47	5.34	1 ½
	63	50	<b>748 410 011</b>	0.005	<b>749 410 011</b>	70	60	5.34	2
	75	65	<b>748 410 014</b>	0.007	<b>749 410 014</b>	93	82	5.34	2 ½
	90	80	<b>748 410 015</b>	0.008	<b>749 410 015</b>	112	101	5.34	3
	*	90	<b>748 410 248</b>	0.008	<b>749 410 248</b>	105	95	5.34	3
	110	100	<b>748 410 016</b>	0.016	<b>749 410 016</b>	134	120	6.99	4



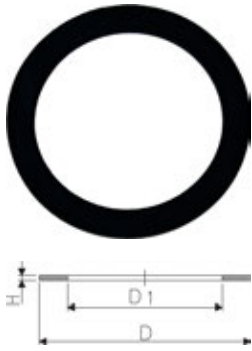

### Flat gasket

#### Model:

- Hardness approx. 65° Shore
- For adaptor unions

Size (inch)	EPDM Code	Weight (kg)	FPM Code	D (mm)	D1 (mm)	H (mm)
¼	748 400 004	0.002		20	13	2
⅜	748 400 005	0.002	749 400 005	24	17	2
½	748 400 006	0.002	749 400 006	30	21	3
¾	748 400 007	0.004	749 400 007	38	27	3
1	748 400 008	0.002	749 400 008	44	32	3
1 ¼	748 400 009	0.007	749 400 009	55	42	3
1 ½	748 400 010	0.004	749 400 010	62	46	3
2	748 400 011	0.005	749 400 011	78	60	3
2 ½	748 400 012	0.010	749 400 012	97	75	3
3	748 400 013	0.011	749 400 013	109	88	3



### Flat gasket EPDM

#### Model:

- Centering on the inner diameter of the screw crown
- Hardness approx. 65° Shore
- Integrated fixation aids from d110
- Centering on the inner diameter of the screw crown

di FA are the suitable inner diameters of flanges adaptors

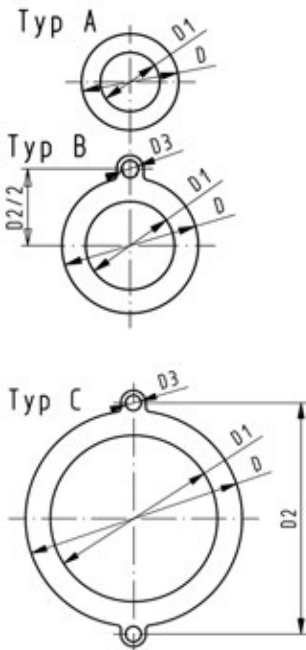

d (mm)	DN (mm)	PN (bar)	Type	EPDM Code	Weight (kg)	D (mm)	D1 (mm)	D2 (mm)	D3 (mm)	H (mm)	di FA (mm)
16	10	10	A	748 400 305	0.004	46	16			2	6 - 26
20	15	10	A	748 400 306	0.012	51	20			2	10 - 30
25	20	10	A	748 400 307	0.004	61	25			2	15 - 35
32	25	10	A	748 400 308	0.008	71	32			2	22 - 42
40	32	10	A	748 400 309	0.013	82	40			3	30 - 50
50	40	10	A	748 400 310	0.016	92	50			3	40 - 60
63	50	10	A	748 400 311	0.018	107	63			3	53 - 73
75	65	10	A	748 400 312	0.029	127	71			3	61 - 81
90	80	10	A	748 400 313	0.035	142	84			3	74 - 94
110	100	10	B	748 400 314	0.051	162	104	180	18	4	94 - 114
125	100	10	B	748 400 315	0.044	162	119	180	18	4	109 - 129
140	125	10	B	748 400 316	0.068	192	134	210	18	4	124 - 144
160 - 180	150	10	B	748 400 317	0.090	218	155	241	22	4	145 - 165
200	200	6	C	748 400 319	0.210	273	195	295	22	5	185 - 205
225	200	6	C	748 400 320	0.140	273	216	295	22	5	206 - 226
250	250	6	C	748 400 321	0.210	328	250	350	22	5	240 - 260
280	250	6	C	748 400 322	0.151	328	273	350	22	5	263 - 283
315	300	6	C	748 400 323	0.237	378	305	400	22	5	295 - 315



484407

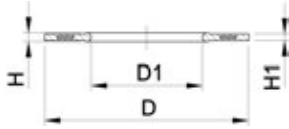

### Profile Flange Gasket, metric EPDM / FPM

#### Model:

- Centering on the inner diameter of the screw crown
  - Hardness: 70° Shore EPDM, 75° Shore FPM
  - EPDM: approved acc. to DVGW W 270, KTW recommendation
  - Centering on the inner diameter of the screw crown
  - Material steel insert: carbon steel
  - Rubber-steel body combined with rubber profile cord ring
- di FA are the suitable inner diameters of flanges adaptors

d (mm)	PN (bar)	DN (mm)	EPDM Code	FPM Code	Weight (kg)	D (mm)	D1 (mm)	H (mm)	H1 (mm)	di FA (mm)
16	16	10	748 440 705	749 440 705	0.012	46	16	4	3	6 - 16
20	16	15	748 440 706	749 440 706	0.013	51	20	4	3	10 - 20
25	16	20	748 440 707	749 440 707	0.014	61	22	4	3	12 - 22
32	16	25	748 440 708	749 440 708	0.019	71	28	4	3	18 - 28
40	16	32	748 440 709	749 440 709	0.026	82	40	4	3	30 - 40
50	16	40	748 440 710	749 440 710	0.039	92	46	4	3	36 - 46
63	16	50	748 440 711	749 440 711	0.050	107	58	5	4	48 - 58
75	16	65	748 440 712	749 440 712	0.082	127	69	5	4	59 - 69
90	16	80	748 440 713	749 440 713	0.083	142	84	5	4	73 - 84
110	16	100	748 440 714	749 440 714	0.127	162	104	6	5	94 - 104
125	16	100	748 440 715	749 440 715	0.105	162	123	6	5	113 - 123
140	16	125	748 440 716	749 440 716	0.173	192	137	6	5	127 - 137
160 - 180	16	150	748 440 717	749 440 717	0.207	218	160	8	6	150 - 160
200	16	200	748 440 719	749 440 719	0.263	273	203	8	6	192 - 203
225	16	200	748 440 720	749 440 720	0.255	273	220	8	6	207 - 220
250	16	250	748 440 721	749 440 721	0.462	328	252	8	6	238 - 252
280	16	250	748 440 722	749 440 722	0.323	328	274	8	6	264 - 274
315	16	300	748 440 723	749 440 723	0.549	378	306	8	6	296 - 306
355	16	350	748 440 724	749 440 724	0.870	438	355	10	7	340 - 355
400	16	400	748 440 725	749 440 725	1.088	489	400	10	7	385 - 400
450	16	500	748 440 726	749 440 726	0.718	594	403	10	7	393 - 403
500	16	500	748 440 727	749 440 727	0.718	594	447	10	7	437 - 447
560	16	600	748 440 728	749 440 728	0.923	695	494	10	7	484 - 494
630	16	600	748 440 729	749 440 729	0.923	695	555	10	7	545 - 555

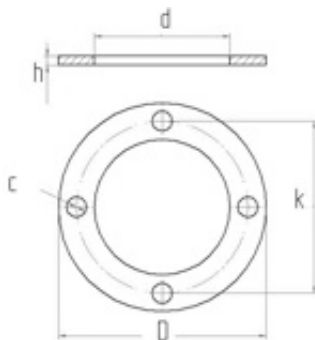

### Flat Gaskets for Full Face Flanges Drilled to BS4504 PN10/16

#### Model:

- For Flange Adaptors
- Hardness approx. 65° Shore

Size (inch)	EPDM Code	Weight (kg)	FPM Code	D (mm)	d (mm)	k (mm)	c (mm)	no. of holes	h (mm)
½	748 401 006	0.040		95	17	67	15	4	3
¾	748 401 007	0.040		105	22	73	15	4	3
1	748 401 008	0.050		115	28	83	15	4	3
1 ¼	748 401 109	0.060	749 401 109	140	36	100	18	4	3
1 ½	748 401 110	0.060	749 401 110	150	45	110	18	4	3
2	748 401 111	0.080	749 401 111	165	58	125	18	4	3
3	748 401 113	0.110	749 401 113	200	83	160	18	8	3
4	748 401 014	0.055		220	109	178	18	8	3
6	748 401 117	0.180	749 401 117	285	161	240	22	8	3

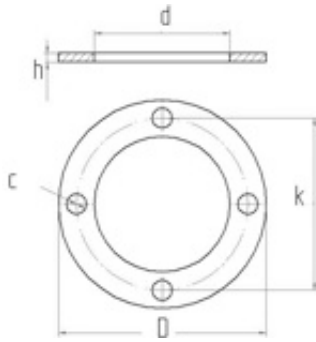

### Flat Gaskets for Full Face Flanges Drilled to BS10 tables D and E

**Model:**

- For Flange Adaptors
- Hardness approx. 65° Shore

Size (inch)	#	EPDM Code	FPM Code	Weight (kg)	D (mm)	d (mm)	k (mm)	c (mm)	no. of holes	h (mm)
½		<b>748 401 006</b>	<b>749 401 006</b>	0.003	95	17	67	15	4	3
¾		<b>748 401 007</b>	<b>749 401 007</b>	0.004	105	22	73	15	4	3
1		<b>748 401 008</b>	<b>749 401 008</b>	0.004	115	28	83	15	4	3
1 ¼		<b>748 401 009</b>	<b>749 401 009</b>	0.003	140	36	88	15	4	3
1 ½		<b>748 401 010</b>	<b>749 401 010</b>	0.004	150	45	98	15	4	3
2		<b>748 401 011</b>	<b>749 401 011</b>	0.105	165	58	115	18	4	3
3		<b>748 401 013</b>	<b>749 401 013</b>	0.011	200	83	146	18	4	3
4	Table E	<b>748 401 014</b>	<b>749 401 014</b>	0.015	220	109	178	18	8	3
4	Table D	<b>748 401 064</b>	<b>749 401 064</b>	0.112	220	109	178	18	4	3
6		<b>748 401 017</b>	<b>749 401 017</b>	0.020	285	161	235	22	8	3

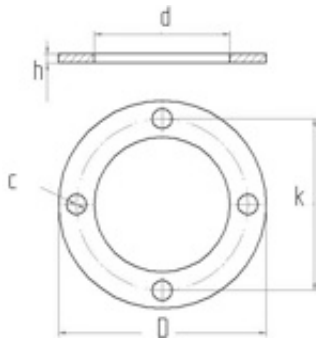

### Flat Gaskets for Full Face Flanges Drilled to ANSI B16.5 Class 150

**Model:**

- For Flange Adaptors
- Hardness approx. 65° Shore

Size (inch)	EPDM Code	Weight (kg)	FPM Code	D (mm)	d (mm)	k (mm)	c (mm)	no. of holes	h (mm)
½	<b>748 401 206</b>	0.040	<b>749 401 206</b>	95	17	60	16	4	3
¾	<b>748 401 207</b>	0.040	<b>749 401 207</b>	105	22	70	16	4	3
1	<b>748 401 208</b>	0.050	<b>749 401 208</b>	115	28	79	16	4	3
1 ¼	<b>748 401 009</b>	0.060		140	36	88	15	4	3
1 ½	<b>748 401 010</b>	0.055		150	45	98	15	4	3
2	<b>748 401 211</b>	0.080	<b>749 401 211</b>	165	58	121	19	4	3
3	<b>748 401 213</b>	0.110	<b>749 401 213</b>	200	83	152	19	4	3
4	<b>748 401 214</b>	0.130	<b>749 401 214</b>	220	109	190	19	8	3

# Index

Code	Page	Code	Page	Code	Page	Code	Page
158 001 041	41	158 001 103	42	161 486 435	66	167 061 162	107
158 001 042	41	158 001 104	42	161 486 436	66	167 482 626	68
158 001 043	41	158 001 105	42	161 486 437	66	167 482 627	68
158 001 044	41	158 001 106	42	161 486 438	66	167 482 628	68
158 001 045	41	158 001 107	42	161 486 443	65	167 482 629	68
158 001 046	41	158 001 108	42	161 486 444	65	167 482 630	68
158 001 047	41	158 001 109	42	161 486 445	65	167 482 631	68
158 001 048	41	158 001 110	42	161 486 446	65	167 482 635	68
158 001 049	41	158 001 111	42	161 486 689	64	167 482 636	68
158 001 050	41	158 001 112	42	161 486 690	64	167 482 637	68
158 001 051	41	158 001 113	42	161 486 691	64	167 482 638	68
158 001 052	41	158 001 114	42	161 490 920	66	167 482 639	68
158 001 053	41	158 001 115	42	161 490 921	66	167 482 640	68
158 001 054	41	158 001 116	42	167 060 019	108	167 482 653	70
158 001 055	41	158 001 117	42	167 060 020	108	167 482 654	70
158 001 056	41	158 001 118	42	167 060 021	108	167 482 655	70
158 001 057	41	158 001 119	42	167 060 022	108	167 482 656	70
158 001 058	41	158 001 120	42	167 060 023	108	167 482 657	70
158 001 059	41	158 001 121	42	167 060 024	108	167 482 658	70
158 001 060	41	158 001 122	42	167 060 025	108	167 482 662	69
158 001 061	41	158 001 123	42	167 060 038	108, 108	167 482 663	69
158 001 062	41	158 001 124	42	167 060 039	108	167 482 664	69
158 001 063	41	161 305 336	94	167 060 040	108	167 482 665	69
158 001 064	41	161 305 337	94	167 060 041	108, 108	167 482 666	69
158 001 065	41	161 305 338	93	167 060 042	108	167 482 667	69
158 001 066	42	161 305 339	93	167 060 043	108	167 482 671	69
158 001 067	42	161 305 386	94	167 060 064	108	167 482 672	69
158 001 068	42	161 305 387	94	167 060 067	108	167 482 673	69
158 001 069	42	161 305 388	93	167 060 070	108	167 482 674	69
158 001 070	42	161 305 389	93	167 061 003	106	167 482 675	69
158 001 071	42	161 305 436	94	167 061 004	106	167 482 676	69
158 001 072	42	161 305 437	94	167 061 012	106	167 482 680	67
158 001 073	42	161 305 438	93	167 061 013	106, 106	167 482 681	67
158 001 074	42	161 305 439	93	167 061 014	106	167 482 682	67
158 001 075	42	161 305 486	94	167 061 015	106	167 482 683	67
158 001 076	42	161 305 487	94	167 061 016	106, 106	167 482 684	67
158 001 077	42	161 305 488	93	167 061 017	106	167 482 685	67
158 001 078	42	161 305 489	93	167 061 035	106	167 484 100	64
158 001 079	42	161 305 536	94	167 061 036	106	167 484 101	64
158 001 080	42	161 305 537	94	167 061 037	106	167 484 102	64
158 001 081	42	161 305 538	93	167 061 038	106	167 484 103	64
158 001 082	42	161 305 539	93	167 061 039	106	167 484 104	64
158 001 083	42	161 305 586	94	167 061 040	106	167 484 105	64
158 001 084	42	161 305 587	94	167 061 041	106	167 484 110	67
158 001 085	42	161 305 588	93	167 061 054	106	167 484 111	67
158 001 086	42	161 305 589	93	167 061 085	106	169 017 087	3
158 001 087	42	161 305 636	94	167 061 086	106	169 017 091	3
158 001 088	42	161 305 637	94	167 061 087	106	169 018 033	3
158 001 089	42	161 305 638	93	167 061 088	106	169 018 034	3
158 001 090	42	161 305 639	93	167 061 089	106	169 018 035	3
158 001 091	42	161 305 686	94	167 061 090	106	169 018 036	3
158 001 092	42	161 305 687	94	167 061 091	106	169 018 038	3
158 001 093	42	161 305 688	93	167 061 112	106	169 018 039	3
158 001 094	42	161 305 689	93	167 061 114	106	169 018 042	3
158 001 095	42	161 486 100	94	167 061 153	107	169 018 045	3
158 001 096	42	161 486 101	94	167 061 155	107	169 018 067	3
158 001 097	42	161 486 102	94	167 061 156	107	169 018 080	3
158 001 098	42	161 486 103	94	167 061 157	107	169 018 081	3
158 001 099	42	161 486 104	94	167 061 158	107	169 018 082	3
158 001 100	42	161 486 105	94	167 061 159	107	169 018 083	3
158 001 101	42	161 486 106	94	167 061 160	107	169 018 084	3
158 001 102	42	161 486 107	94	167 061 161	107	169 018 085	3

# Index

Code	Page	Code	Page	Code	Page	Code	Page
169 018 086	3	169 480 801	63	169 543 045	54	169 543 606	60
169 018 088	3	169 480 802	63	169 543 046	54	169 543 607	60
169 018 089	3	169 480 803	63	169 543 047	54	169 546 021	50
169 018 106	4	169 480 804	63	169 543 061	52	169 546 022	50
169 018 107	4	169 480 805	63	169 543 062	52	169 546 023	50
169 018 108	4	169 480 806	63	169 543 063	52	169 546 024	50
169 018 109	4	169 480 808	63	169 543 064	52	169 546 025	50
169 018 110	4	169 480 809	63	169 543 065	52	169 546 026	50
169 018 111	4	169 480 925	64	169 543 066	52	169 546 027	50
169 110 056	41	169 480 926	64	169 543 067	52	169 546 061	48
169 110 066	41	169 480 927	64	169 543 201	57	169 546 062	48
169 110 097	41	169 480 928	64	169 543 202	57	169 546 063	48
169 110 117	41	169 480 929	64	169 543 203	57	169 546 064	48
169 250 225	20	169 480 930	64	169 543 204	57	169 546 065	48
169 250 226	20	169 480 931	64	169 543 205	57	169 546 066	48
169 250 227	20	169 514 012	71	169 543 206	57	169 546 067	48
169 250 228	20	169 514 013	71	169 543 207	57	169 546 068	46, 48
169 250 229	20	169 514 014	71	169 543 241	58	169 546 069	48
169 250 230	20	169 514 015	71	169 543 242	58	169 546 070	48
169 250 231	20	169 514 016	71	169 543 243	58	169 546 081	49
169 280 002	13	169 514 017	71	169 543 244	58	169 546 082	49
169 280 003	13	169 514 032	71	169 543 245	58	169 546 083	49
169 280 004	13	169 514 033	71	169 543 246	58	169 546 084	49
169 280 005	13	169 514 034	71	169 543 247	58	169 546 085	49
169 280 006	13	169 514 035	71	169 543 261	56	169 546 086	49
169 280 007	13	169 514 036	71	169 543 262	56	169 546 087	49
169 303 006	87	169 514 037	71	169 543 263	56	169 546 088	47, 49
169 303 007	87	169 514 512	71	169 543 264	56	169 546 089	49
169 303 008	87	169 514 513	71	169 543 265	56	169 546 090	49
169 303 009	87	169 514 514	71	169 543 266	56	169 546 221	47
169 303 010	87	169 514 515	71	169 543 267	56	169 546 222	47
169 303 011	87	169 514 516	71	169 543 302	55	169 546 223	47
169 305 302	93	169 514 517	71	169 543 303	55	169 546 224	47
169 305 303	93	169 514 532	71	169 543 304	55	169 546 225	47
169 305 304	93	169 514 533	71	169 543 305	55	169 546 226	47
169 305 305	93	169 514 534	71	169 543 306	55	169 546 227	47
169 305 306	93	169 514 535	71	169 543 307	55	169 546 229	47
169 305 307	93	169 514 536	71	169 543 322	59	169 546 230	47
169 317 024	73	169 514 537	71	169 543 323	59	169 546 241	46
169 317 025	73	169 515 012	72	169 543 324	59	169 546 242	46
169 317 038	73	169 515 013	72	169 543 325	59	169 546 243	46
169 317 039	73	169 515 014	72	169 543 326	59	169 546 244	46
169 317 040	73	169 515 015	72	169 543 327	59	169 546 245	46
169 317 423	73	169 515 016	72	169 543 401	61	169 546 246	46
169 480 775	63	169 515 017	72	169 543 402	61	169 546 247	46
169 480 776	63	169 515 032	72	169 543 403	61	169 546 249	46
169 480 777	63	169 515 033	72	169 543 404	61	169 546 250	46
169 480 778	63	169 515 034	72	169 543 405	61	169 561 001	88
169 480 779	63	169 515 035	72	169 543 406	61	169 561 002	88
169 480 780	63	169 515 036	72	169 543 407	61	169 561 003	88
169 480 781	63	169 515 037	72	169 543 421	62	169 561 004	88
169 480 782	63, 63	169 543 001	53	169 543 422	62	169 561 005	88
169 480 783	63	169 543 002	53	169 543 423	62	169 561 006	88
169 480 784	63	169 543 003	53	169 543 424	62	169 561 007	88
169 480 786	63	169 543 004	53	169 543 425	62	169 561 008	88
169 480 787	63	169 543 005	53	169 543 426	62	169 561 009	88
169 480 788	63	169 543 006	53	169 543 427	62	169 561 010	88
169 480 789	63	169 543 007	53	169 543 601	60	169 561 021	89
169 480 790	63	169 543 041	54	169 543 602	60	169 561 022	89
169 480 791	63	169 543 042	54	169 543 603	60	169 561 023	89
169 480 792	63	169 543 043	54	169 543 604	60	169 561 024	89
169 480 800	63	169 543 044	54	169 543 605	60	169 561 025	89

# Index

Code	Page	Code	Page	Code	Page	Code	Page
169 561 026	89	169 567 807	74	169 591 005	91	173 061 167	108
169 561 027	89	169 567 808	74	169 591 006	91	198 335 962	102
169 561 061	88	169 567 809	74	169 591 007	91	198 335 963	102
169 561 062	88	169 567 810	74	169 591 008	91, 91	198 335 964	102
169 561 063	88	169 578 002	78	169 591 009	91	198 335 965	102
169 561 064	88	169 578 003	78	169 591 010	91	198 335 966	102
169 561 065	88	169 578 004	78	169 591 101	91	198 335 967	102
169 561 066	88	169 578 005	78	169 591 102	91	198 335 968	102
169 561 067	88	169 578 006	78	169 591 103	91	198 335 969	102
169 561 068	88	169 578 007	78	169 591 104	91	198 335 991	102
169 561 069	88	169 578 008	78	169 591 105	91	198 335 992	102
169 561 070	88	169 578 009	78	169 591 106	91	198 335 993	102
169 562 001	90	169 578 010	78	169 591 107	91	198 335 994	102
169 562 002	90	169 578 022	79	169 591 109	91	198 335 995	102
169 562 003	90	169 578 023	79	169 591 110	91	198 335 998	103
169 562 004	90	169 578 024	79	169 595 001	92	198 335 999	103
169 562 005	90	169 578 025	79	169 595 002	92	198 802 814	95
169 562 006	90	169 578 026	79	169 595 003	92	198 802 815	95
169 562 007	90	169 578 027	79	169 595 004	92	198 802 816	95
169 562 008	90	169 578 028	79	169 595 005	92	198 802 817	95
169 562 009	90	169 578 029	79	169 595 006	92	198 802 818	95
169 562 010	90	169 578 030	79	169 595 007	92	198 802 819	95
169 562 021	90	169 578 102	81	169 595 008	92, 92	198 802 820	95
169 562 022	90	169 578 103	81	169 595 009	92	198 802 821	95
169 562 023	90	169 578 104	81	169 595 010	92	198 802 822	95
169 562 024	90	169 578 105	81	169 595 101	92	198 802 823	95
169 562 025	90	169 578 106	81	169 595 102	92	198 802 824	95
169 562 026	90	169 578 107	81	169 595 103	92	198 802 825	95
169 562 027	90	169 578 108	81	169 595 104	92	198 802 826	96
169 562 061	89	169 578 109	81	169 595 105	92	198 802 827	96
169 562 062	89	169 578 110	81	169 595 106	92	198 802 828	96
169 562 063	89	169 578 122	82	169 595 107	92	198 802 829	96
169 562 064	89	169 578 123	82	169 595 109	92	198 802 830	96
169 562 065	89	169 578 124	82	169 595 110	92	198 802 831	96
169 562 066	89	169 578 125	82	173 061 003	107	198 802 832	96
169 562 067	89	169 578 126	82	173 061 004	107	198 802 833	96
169 562 068	89	169 578 127	82	173 061 005	107	198 802 834	96
169 562 069	89	169 578 128	82	173 061 006	107	198 802 835	96
169 562 070	89	169 578 129	82	173 061 007	107	198 802 836	96
169 567 002	75	169 578 130	82	173 061 008	107	198 802 837	96
169 567 003	75	169 578 802	77	173 061 009	107	198 807 040	99
169 567 004	75	169 578 803	77	173 061 010	107	198 807 041	99
169 567 005	75	169 578 804	77	173 061 011	107	198 807 042	99
169 567 006	75	169 578 805	77	173 061 012	107	198 807 043	99
169 567 007	75	169 578 806	77	173 061 013	107	198 807 044	99
169 567 008	75	169 578 807	77	173 061 014	107	198 807 045	99
169 567 009	75	169 578 808	77	173 061 015	107	198 807 046	99
169 567 010	75	169 578 809	77	173 061 016	107	198 807 047	99
169 567 022	76	169 578 810	77	173 061 017	107	198 807 048	99
169 567 023	76	169 578 902	80	173 061 153	107	198 807 049	99
169 567 024	76	169 578 903	80	173 061 155	107	198 807 050	100
169 567 025	76	169 578 904	80	173 061 156	107	198 807 051	100
169 567 026	76	169 578 905	80	173 061 157	107	198 807 052	100
169 567 027	76	169 578 906	80	173 061 158	107	198 807 053	100
169 567 028	76	169 578 907	80	173 061 159	107	198 807 054	100
169 567 029	76	169 578 908	80	173 061 160	107	198 807 055	100
169 567 030	76	169 578 909	80	173 061 161	107	198 807 056	100
169 567 802	74	169 578 910	80	173 061 162	107	198 807 057	100
169 567 803	74	169 591 001	91	173 061 163	107	198 807 058	100
169 567 804	74	169 591 002	91	173 061 164	108	198 807 059	100
169 567 805	74	169 591 003	91	173 061 165	108	198 807 120	97
169 567 806	74	169 591 004	91	173 061 166	108	198 807 121	97

# Index

Code	Page	Code	Page	Code	Page	Code	Page
198 807 122	97	199 038 028	86	199 038 414	85	199 039 400	83
198 807 123	97	199 038 029	86	199 038 415	85	199 039 401	83
198 807 124	97	199 038 030	86	199 038 416	85	199 039 402	83
198 807 125	97	199 038 031	86	199 038 417	85	199 039 403	83
198 807 126	97	199 038 032	86	199 038 418	85	199 039 404	83
198 807 127	97	199 038 033	86	199 038 419	85	199 039 405	83
198 807 128	97	199 038 034	86	199 038 420	85	199 039 406	83
198 807 129	97	199 038 039	86	199 038 421	85	199 039 407	83
198 807 130	97	199 038 040	86	199 038 426	86	199 039 408	83
198 807 131	97	199 038 041	86	199 038 427	86	199 039 426	84
198 807 132	98	199 038 042	86	199 038 428	86	199 039 427	84
198 807 133	98	199 038 043	86	199 038 429	86	199 039 428	84
198 807 134	98	199 038 044	86	199 038 430	86	199 039 429	84
198 807 135	98	199 038 045	86	199 038 431	86	199 039 430	84
198 807 136	98	199 038 046	86	199 038 432	86	199 039 431	84
198 807 137	98	199 038 047	86	199 038 433	86	199 039 432	84
198 807 138	98	199 038 200	85	199 038 434	86	199 039 433	84
198 807 139	98	199 038 201	85	199 038 439	86	199 039 434	84
198 807 140	98	199 038 202	85	199 038 440	86	20014B601	24
198 807 141	98	199 038 203	85	199 038 441	86	20014B602	24
198 807 142	98	199 038 204	85	199 038 442	86	20014B603	24
198 807 143	98	199 038 205	85	199 038 443	86	20014B604	24
198 807 144	101	199 038 206	85	199 038 444	86	20014B605	24
198 807 145	101	199 038 207	85	199 038 445	86	20014B606	24
198 807 146	101	199 038 208	85	199 038 446	86	20014B607	24
198 807 147	101	199 038 213	85	199 038 447	86	20014B608	24
198 807 148	101	199 038 214	85	199 039 000	83	20014B609	24
198 807 149	101	199 038 215	85	199 039 001	83	20014B610	24
198 807 150	101	199 038 216	85	199 039 002	83	20014B611	24
198 807 151	101	199 038 217	85	199 039 003	83	20014B612	24
198 807 152	101	199 038 218	85	199 039 004	83	20014B613	24
198 807 153	101	199 038 219	85	199 039 005	83	20014B614	24
198 807 154	102	199 038 220	85	199 039 006	83	20014B615	24
198 807 155	102	199 038 221	85	199 039 007	83	20014B616	24
198 807 156	102	199 038 226	86	199 039 008	83	700 244 660	30
198 807 157	102	199 038 227	86	199 039 026	84	720 510 106	40
198 807 158	102	199 038 228	86	199 039 027	84	720 510 107	40
198 807 159	102	199 038 229	86	199 039 028	84	720 510 108	40
198 807 160	102	199 038 230	86	199 039 029	84	720 510 109	40
198 807 161	102	199 038 231	86	199 039 030	84	720 510 110	40
198 807 162	102	199 038 232	86	199 039 031	84	724 700 014	111
198 807 163	102	199 038 233	86	199 039 032	84	724 701 406	110
199 038 000	85	199 038 234	86	199 039 033	84	724 701 407	110
199 038 001	85	199 038 239	86	199 039 034	84	724 701 408	110
199 038 002	85	199 038 240	86	199 039 200	83	724 701 409	110
199 038 003	85	199 038 241	86	199 039 201	83	724 701 410	110
199 038 004	85	199 038 242	86	199 039 202	83	724 701 411	110
199 038 005	85	199 038 243	86	199 039 203	83	724 701 412	110
199 038 006	85	199 038 244	86	199 039 204	83	724 701 413	110
199 038 007	85	199 038 245	86	199 039 205	83	724 701 414	110
199 038 008	85	199 038 246	86	199 039 206	83	724 701 415	110
199 038 013	85	199 038 247	86	199 039 207	83	724 701 416	110
199 038 014	85	199 038 400	85	199 039 208	83	724 701 417	110
199 038 015	85	199 038 401	85	199 039 226	84	724 701 419	110
199 038 016	85	199 038 402	85	199 039 227	84	724 701 606	111
199 038 017	85	199 038 403	85	199 039 228	84	724 701 607	111
199 038 018	85	199 038 404	85	199 039 229	84	724 701 608	111
199 038 019	85	199 038 405	85	199 039 230	84	724 701 609	111
199 038 020	85	199 038 406	85	199 039 231	84	724 701 610	111
199 038 021	85	199 038 407	85	199 039 232	84	724 701 611	111
199 038 026	86	199 038 408	85	199 039 233	84	724 701 612	111
199 038 027	86	199 038 413	85	199 039 234	84	724 701 613	111



# Index

Code	Page	Code	Page	Code	Page	Code	Page
724 701 615	111	727 701 212	114	729 101 111	6	729 200 152	27
724 701 616	111	727 701 213	114	729 101 113	6	729 200 153	27
724 701 617	111	727 701 214	114	729 101 115	6	729 200 156	27
724 701 720	111	727 701 406	112	729 101 117	6	729 200 157	27
724 701 806	111	727 701 407	112	729 101 206	10	729 200 158	27
724 701 807	111	727 701 408	112	729 101 207	10	729 200 164	27
724 701 808	111	727 701 409	112	729 101 208	10	729 200 170	27
724 701 809	111	727 701 410	112	729 150 106	26	729 200 178	27
724 701 810	111	727 701 411	112	729 150 107	26	729 200 182	27
724 701 811	111	727 701 412	112	729 150 108	26	729 201 009	7
724 701 812	111	727 701 413	112	729 150 109	26	729 201 011	7
724 701 813	111	727 701 414	112	729 150 110	26	729 201 105	6
724 701 815	111	727 701 422	113	729 150 111	26	729 201 106	6
724 701 816	111	727 701 423	113	729 150 112	6, 26	729 201 107	6
724 701 817	111	729 000 106	25	729 150 113	26	729 201 108	6
724 701 820	111	729 000 107	25	729 150 114	26	729 201 109	6
724 703 414	110	729 000 108	25	729 150 116	6, 26	729 201 110	6
724 703 814	111	729 000 109	25	729 150 117	26	729 201 111	6
727 700 031	113	729 000 110	25	729 150 119	26	729 201 113	6
727 700 206	113	729 000 111	25	729 150 120	26	729 201 115	6
727 700 207	113	729 000 112	5, 25	729 150 121	26	729 201 117	6
727 700 208	113	729 000 113	25	729 150 122	26	729 201 120	6
727 700 209	113	729 000 114	25	729 150 123	26	729 201 134	7
727 700 210	113	729 000 116	25	729 151 105	6	729 201 137	7
727 700 211	113	729 000 117	25	729 151 106	6	729 201 138	7
727 700 212	113	729 001 106	5	729 151 107	6	729 201 141	7
727 700 213	113	729 001 107	5	729 151 108	6	729 201 147	7
727 700 214	113	729 001 108	5	729 151 109	6	729 201 151	7
727 700 406	112	729 001 109	5	729 151 110	6	729 201 164	7
727 700 407	112	729 001 110	5	729 151 111	6	729 201 170	7
727 700 408	112	729 001 111	5	729 151 113	6	729 201 178	7
727 700 409	112	729 001 113	5	729 151 115	6	729 250 106	28
727 700 410	112	729 001 115	5	729 151 117	6	729 250 107	28
727 700 411	112	729 010 120	25	729 151 120	6	729 250 108	28
727 700 412	112	729 010 122	25	729 200 010	27	729 250 109	28
727 700 413	112	729 010 123	25	729 200 011	27	729 250 110	28
727 700 414	112	729 011 120	5	729 200 106	27	729 250 111	28
727 700 416	112	729 100 106	26	729 200 107	27	729 250 112	7, 28
727 700 417	112, 112	729 100 107	26	729 200 108	27	729 250 113	28
727 700 419	112, 113	729 100 108	26	729 200 109	27	729 250 114	28
727 700 420	112, 113	729 100 109	26	729 200 110	27	729 251 106	7
727 700 421	112	729 100 110	26	729 200 111	27	729 251 107	7
727 700 422	112	729 100 111	26	729 200 112	6, 27	729 251 108	7
727 700 423	112	729 100 112	6, 26	729 200 113	27	729 251 109	7
727 700 424	112	729 100 113	26	729 200 114	27	729 251 110	7
727 700 425	112	729 100 114	26	729 200 116	6, 27	729 251 111	7
727 700 815	113	729 100 116	6, 26	729 200 117	27	729 300 108	28
727 700 816	113	729 100 117	26	729 200 119	27	729 300 111	28
727 700 817	113, 114	729 100 119	26	729 200 120	27	729 300 113	28
727 700 819	113, 114	729 100 121	26	729 200 121	27	729 510 106	36
727 700 820	113, 114	729 100 206	32	729 200 122	27	729 510 107	36
727 700 821	113	729 100 207	32	729 200 123	27	729 510 108	36
727 700 822	113	729 100 208	32	729 200 134	27	729 510 109	36
727 700 823	113	729 100 209	32	729 200 136	27	729 510 110	36
727 700 824	113	729 100 210	32	729 200 138	27	729 510 111	36
727 700 825	113	729 100 211	32	729 200 143	27	729 510 112	16, 36
727 701 206	114	729 101 105	6	729 200 144	27	729 510 114	36
727 701 207	114	729 101 106	6	729 200 146	27	729 510 313	36
727 701 208	114	729 101 107	6	729 200 147	27	729 511 105	16
727 701 209	114	729 101 108	6	729 200 148	27	729 511 106	16
727 701 210	114	729 101 109	6	729 200 149	27	729 511 107	16
727 701 211	114	729 101 110	6	729 200 151	27	729 511 108	16



# Index

Code	Page	Code	Page	Code	Page	Code	Page
729 511 109	16	729 545 508	40	729 790 110	35	729 900 359	30
729 511 110	16	729 545 509	40	729 790 111	35	729 900 360	30
729 511 111	16	729 545 510	40	729 790 112	15, 35	729 900 364	30
729 511 205	18	729 545 511	40	729 790 113	35	729 900 365	30
729 511 206	18	729 550 506	38	729 790 114	35	729 900 370	30
729 511 207	18	729 550 507	38	729 790 116	15, 35	729 900 371	30
729 511 208	18	729 550 508	38	729 790 117	35	729 900 372	30
729 511 209	18	729 550 509	38	729 790 119	35	729 900 376	30
729 511 210	18	729 550 510	38	729 790 120	35	729 900 378	30
729 511 211	18	729 550 511	38	729 790 121	35	729 900 385	30
729 521 105	18	729 550 906	39	729 790 122	35	729 900 388	30
729 521 106	18	729 550 907	39	729 790 123	35	729 900 390	30
729 521 107	18	729 550 908	39	729 791 106	15	729 900 392	30
729 521 108	18	729 550 909	39	729 791 107	15	729 900 396	30
729 521 109	18	729 550 910	39	729 791 108	15	729 900 406	33
729 521 110	18	729 550 911	39	729 791 109	15	729 900 407	33
729 521 111	18	729 550 957	39	729 791 110	15	729 900 408	33
729 523 105	18	729 550 958	39	729 791 111	15	729 900 409	33
729 523 106	18	729 550 967	39	729 791 113	15	729 900 410	33
729 523 107	18	729 550 968	39	729 791 115	15	729 900 411	33
729 523 108	18	729 551 506	19	729 791 117	15	729 900 906	29
729 523 109	18	729 551 507	19	729 791 120	15	729 900 907	29
729 523 110	18	729 551 508	19	729 800 106	36	729 900 908	29
729 523 111	18	729 551 509	19	729 800 107	36	729 900 909	29
729 530 306	38	729 551 510	19	729 800 108	36	729 900 910	29
729 530 307	38	729 551 511	19	729 800 109	36	729 900 911	29
729 530 308	38	729 551 906	20	729 800 110	36	729 900 912	8, 29
729 530 309	38	729 551 907	20	729 800 111	36	729 900 913	29
729 530 310	38	729 551 908	20	729 800 162	36	729 900 914	29
729 530 311	38	729 551 909	20	729 800 163	36	729 900 916	8
729 530 806	38	729 551 910	20	729 800 164	36	729 901 334	8
729 530 807	38	729 551 911	20	729 840 106	36	729 901 337	8
729 530 808	38	729 601 105	16	729 840 107	36	729 901 341	8
729 530 809	38	729 601 106	16	729 840 108	36	729 901 342	8
729 530 810	38	729 601 107	16	729 840 109	36	729 901 346	8
729 530 811	38	729 601 108	16	729 840 110	36	729 901 347	8
729 531 306	19	729 601 109	16	729 840 111	36	729 901 348	8
729 531 307	19	729 601 110	16	729 840 112	36	729 901 352	8
729 531 308	19	729 601 111	16	729 840 114	36	729 901 353	8
729 531 309	19	729 641 105	16	729 840 123	36	729 901 354	8
729 531 310	19	729 641 106	16	729 890 405	37	729 901 355	8
729 531 311	19	729 641 107	16	729 890 406	17, 37	729 901 358	8
729 531 806	19	729 641 108	16	729 890 407	17, 37	729 901 359	8
729 531 807	19	729 641 109	16	729 890 408	17, 37	729 901 360	8
729 531 808	19	729 641 110	16	729 890 409	17, 37	729 901 361	8
729 531 809	19	729 641 111	16	729 890 410	17, 37	729 901 364	8
729 531 810	19	729 690 012	37	729 890 411	17, 37	729 901 370	8
729 531 811	19	729 690 013	37	729 900 181	30	729 901 371	8
729 540 206	39	729 690 014	37	729 900 303	30	729 901 372	8
729 540 207	39	729 733 106	15	729 900 306	30	729 901 374	8
729 540 208	39	729 733 107	15	729 900 312	30	729 901 381	8
729 540 209	39	729 733 108	15	729 900 337	30	729 901 385	8
729 540 210	39	729 733 109	15	729 900 341	30	729 901 396	8
729 540 211	39	729 733 110	15	729 900 342	30	729 901 406	11
729 540 706	39	729 733 111	15	729 900 346	30	729 901 407	11
729 540 707	39	729 733 113	15	729 900 347	30	729 901 408	11
729 540 708	39	729 733 114	15	729 900 348	30	729 901 409	11
729 540 709	39	729 733 117	15	729 900 352	30	729 901 410	11
729 540 710	39	729 790 106	35	729 900 353	30	729 901 411	11
729 540 711	39	729 790 107	35	729 900 354	30	729 901 534	11
729 545 506	40	729 790 108	35	729 900 355	30	729 901 537	11
729 545 507	40	729 790 109	35	729 900 358	30	729 901 541	11

# Index

Code	Page	Code	Page	Code	Page	Code	Page
729 901 542	11	729 911 106	7	729 960 117	31	748 401 007	117, 118
729 901 905	8	729 911 107	7	729 960 406	34	748 401 008	117, 118
729 901 906	8	729 911 108	7	729 960 407	34	748 401 009	118, 118
729 901 907	8	729 911 109	7	729 960 408	34	748 401 010	118, 118
729 901 908	8	729 911 110	7	729 960 409	34	748 401 011	118
729 901 909	8	729 911 111	7	729 960 508	34	748 401 013	118
729 901 910	8	729 911 113	7	729 961 105	9	748 401 014	117, 118
729 901 911	8	729 911 115	7	729 961 106	9	748 401 017	118
729 901 913	8	729 911 117	7	729 961 107	9	748 401 064	118
729 901 914	8	729 911 120	7	729 961 108	9	748 401 109	117
729 910 106	29	729 911 389	9	729 961 109	9	748 401 110	117
729 910 107	29	729 911 505	13	729 961 110	9	748 401 111	117
729 910 108	29	729 911 509	13	729 961 111	9	748 401 113	117
729 910 109	29	729 911 510	13	729 961 113	9	748 401 117	117
729 910 110	29	729 911 511	13	729 961 115	9	748 401 206	118
729 910 111	29	729 911 555	12	729 961 706	12	748 401 207	118
729 910 112	7, 10, 29, 32	729 911 556	12	729 961 707	12	748 401 208	118
729 910 113	29	729 911 557	12	729 961 708	12	748 401 211	118
729 910 114	29	729 911 558	12	729 961 906	14	748 401 213	118
729 910 116	7, 29	729 911 705	11	729 961 907	14	748 401 214	118
729 910 117	29	729 911 706	11	729 961 908	14	748 410 004	115
729 910 119	29	729 911 707	11	748 400 004	116	748 410 005	115
729 910 120	29	729 911 708	11	748 400 005	116	748 410 006	115
729 910 121	29	729 911 709	11	748 400 006	116	748 410 007	115
729 910 122	29	729 911 710	11	748 400 007	116	748 410 008	115
729 910 123	29	729 911 711	11	748 400 008	116	748 410 009	115
729 910 206	32	729 911 906	13	748 400 009	116	748 410 010	115
729 910 207	32	729 911 907	13	748 400 010	116	748 410 011	115
729 910 208	32	729 911 908	13	748 400 011	116	748 410 014	115
729 910 209	32	729 913 106	10, 32	748 400 012	116	748 410 015	115
729 910 210	32	729 913 107	10, 32	748 400 013	116	748 410 016	115
729 910 211	32	729 913 108	10, 32	748 400 014	114	748 410 248	115
729 910 342	30	729 913 109	10, 32	748 400 015	114	748 440 705	117
729 910 347	30	729 913 110	10, 32	748 400 016	114	748 440 706	117
729 910 354	30	729 913 111	10, 32	748 400 017	114	748 440 707	117
729 910 360	30	729 913 113	10, 32	748 400 018	114	748 440 708	117
729 910 366	30	729 913 115	10, 32	748 400 019	114	748 440 709	117
729 910 371	30	729 913 905	12	748 400 020	114	748 440 710	117
729 910 434	33	729 913 906	12	748 400 021	114	748 440 711	117
729 910 437	33	729 913 907	12	748 400 022	114	748 440 712	117
729 910 441	33	729 913 908	12	748 400 023	114	748 440 713	117
729 910 446	33	729 913 909	12	748 400 025	114	748 440 714	117
729 910 452	33	729 913 910	12	748 400 026	114	748 440 714	117
729 910 458	33	729 913 911	12	748 400 027	114	748 440 715	117
729 910 556	33	729 913 913	12	748 400 305	116	748 440 716	117
729 910 557	33	729 913 915	12	748 400 306	116	748 440 717	117
729 910 558	33	729 913 915	12	748 400 307	116	748 440 719	117
729 910 559	33	729 950 106	34	748 400 308	116	748 440 720	117
729 910 560	33	729 950 107	34	748 400 309	116	748 440 721	117
729 910 561	33	729 950 108	34	748 400 310	116	748 440 722	117
729 910 606	13	729 950 606	34	748 400 311	116	748 440 722	117
729 910 607	13	729 950 607	34	748 400 312	116	748 440 724	117
729 910 608	13	729 950 608	34	748 400 313	116	748 440 725	117
729 911 005	10	729 960 106	31	748 400 314	116	748 440 726	117
729 911 006	10	729 960 107	31	748 400 315	116	748 440 727	117
729 911 007	10	729 960 108	31	748 400 316	116	748 440 728	117
729 911 008	10	729 960 109	31	748 400 317	116	748 440 729	117
729 911 009	10	729 960 110	31	748 400 319	116	749 400 005	116
729 911 010	10	729 960 111	31	748 400 320	116	749 400 006	116
729 911 011	10	729 960 112	9, 31	748 400 321	116	749 400 007	116
729 911 105	7	729 960 113	31	748 400 322	116	749 400 008	116
		729 960 114	31	748 400 323	116	749 400 009	116
		729 960 116	9, 31	748 401 006	117, 118	749 400 010	116

# Index

<b>Code</b>	<b>Page</b>	<b>Code</b>	<b>Page</b>
749 400 011	116	749 440 722	117
749 400 012	116	749 440 723	117
749 400 013	116	749 440 724	117
749 400 015	114	749 440 725	117
749 400 016	114	749 440 726	117
749 400 017	114	749 440 727	117
749 400 018	114	749 440 728	117
749 400 020	114	749 440 729	117
749 400 021	114	790 109 001	109
749 400 022	114	790 109 002	109
749 400 025	114	790 109 003	109
749 400 026	114	790 309 003	109
749 400 027	114	790 309 004	109
749 401 006	118	799 298 010	109
749 401 007	118	799 298 022	109
749 401 008	118	799 298 028	110
749 401 009	118	799 299 001	110
749 401 010	118	799 299 002	110
749 401 011	118	799 299 003	110
749 401 013	118	799 299 004	110
749 401 014	118	799 299 005	110
749 401 017	118	800 015 141	50
749 401 064	118	800 015 142	50
749 401 109	117	800 015 143	50
749 401 110	117	800 015 179	50
749 401 111	117	800 024 832	50
749 401 113	117	800 024 834	50
749 401 117	117	800 045 326	50
749 401 206	118	800 045 327	50
749 401 207	118	800 045 328	50
749 401 208	118		
749 401 211	118		
749 401 213	118		
749 401 214	118		
749 410 004	115		
749 410 005	115		
749 410 006	115		
749 410 007	115		
749 410 008	115		
749 410 009	115		
749 410 010	115		
749 410 011	115		
749 410 014	115		
749 410 015	115		
749 410 016	115		
749 410 248	115		
749 440 705	117		
749 440 706	117		
749 440 707	117		
749 440 708	117		
749 440 709	117		
749 440 710	117		
749 440 711	117		
749 440 712	117		
749 440 713	117		
749 440 714	117		
749 440 715	117		
749 440 716	117		
749 440 717	117		
749 440 719	117		
749 440 720	117		
749 440 721	117		

# GEORGE FISCHER SALES LIMITED ("George Fischer") CONDITIONS OF SALE (FOR GOODS AND SERVICES)

## 1 INTERPRETATION

- 1.1 In these conditions of sale the following words will (unless otherwise stated) have the following meanings: "**Conditions**" means the terms and conditions set out in this document. "**Contract**" means any contract between George Fischer and the Customer for the supply of any Works. "**Customer**" means the company, firm, body or person purchasing the Works. "**Custom Goods**" means each product supplied by George Fischer in accordance with the Customer Design Requirements. "**Customer Design Requirements**" means the drawings, designs, parameters or specifications for Goods which are provided by the Customer and to which George Fischer has agreed in writing. "**Customer's Property**" means any dies, tools, patterns, packagings and any other equipment, goods, materials, or information supplied by or on behalf of the Customer to George Fischer in connection with the Works. "**Deliverables**" means the items produced by George Fischer and supplied to the Customer as part of the Services (other than Goods). "**Goods**" means any and all goods (including without limitation Custom Goods and Standard Goods) agreed in the Contract to be provided by George Fischer to the Customer (including but not limited to the whole or any part or parts of them, any raw materials, finished or semi-finished materials, machinery, parts, spares, commodities and any materials, articles and commodities supplied in connection with such Goods). "**IPR**" means patents, registered designs, unregistered designs, copyright and related rights, database rights, trademarks, trade names and domain names, rights in get-up, rights in goodwill or to sue for passing off or other industrial or intellectual property rights in each case whether registered or unregistered and including all applications (or rights to apply) for and renewals or extensions of, such rights and all similar or equivalent rights or forms of protection which may now or in the future subsist in any part of the world. "**Services**" means any services agreed in the Contract to be provided by George Fischer to the Customer (including but not limited to the whole or any part or parts of them). "**Standard Goods**" means any goods agreed in the Contract to be provided by George Fischer to the Customer other than the Custom Goods. "**Works**" means the Goods and/or the Services (as appropriate).
- 1.2 Any reference in these Conditions to any statute or statutory provision will (unless otherwise stated) be construed as a reference to that statute or statutory provision as may be amended, consolidated, modified, extended, re-enacted or replaced from time to time.
- 1.3 The headings in these Conditions are for reference only and will not affect the interpretation of these Conditions.
- 1.4 In these Conditions any use of the phrase "unless otherwise agreed in writing" or any similar phrase will mean unless otherwise agreed in writing and signed by a director or commercial manager of George Fischer.
- 1.5 George Fischer reserves the right at any time to correct any clerical, typographical or other similar errors made by its employees, and shall not be bound by any such errors.
- ## 2 QUOTATIONS
- 2.1 Any quotation (whether written or oral) is given on the basis that no contract will come into existence otherwise than in accordance with the provisions of clauses 3.5 and 3.6.
- 2.2 Unless otherwise agreed in writing any quotation is valid only for a period of 45 days from its date of issue provided that George Fischer has not previously withdrawn it by written or oral notice to the Customer.
- 2.3 Any quotation is based on the instructions and information provided by the Customer and George Fischer reserves the right to amend the quotation at any time to cover any increase in price which may arise as a result of additional, amended or incomplete instructions or information.
- ## 3 APPLICATION OF TERMS
- 3.1 Subject to clause 3.4 these Conditions are the only conditions on which George Fischer is prepared to deal with the Customer and they will apply to all Contracts to the exclusion of any other terms and conditions including but not limited to those which the Customer purports to apply.
- 3.2 No terms or conditions endorsed upon, delivered with, referred to or stipulated or contained in any purchase order, correspondence or any other document delivered or sent by the Customer to George Fischer will form part of the Contract.
- 3.3 Any reference in the Contract or in any dealings between the parties to the Customer's purchase order or other similar document will not be deemed to imply that any terms or conditions endorsed upon, delivered with, referred to or stipulated or contained in such purchase order or other document will have any effect or operate to exclude or amend these Conditions.
- 3.4 Any variation to these Conditions and any representation about the Works will only be effective if it is agreed in writing, contains a specific reference to these Conditions and is signed by a director or commercial manager of both parties.
- 3.5 Each purchase order for Works issued by the Customer will be deemed to be an offer by the Customer to purchase Works subject to these Conditions.
- 3.6 No purchase order placed by the Customer will be deemed to be accepted by George Fischer until a written acknowledgement of order is issued by George Fischer or (if earlier) George Fischer commences the Works or supplies the Works to the Customer.
- 3.7 The Customer acknowledges and accepts that:
- it is fully responsible for the contents of its order and the Customer Design Requirements, and must ensure that they are complete and accurate; and
  - Standard Goods are commercial "off the shelf" products and are not made to satisfy any Customer requirements.
- 3.8 Unless otherwise agreed in writing all drawings, illustrations, descriptions, specifications, technical data, advertising and other similar information issued by George Fischer or contained in George Fischer's catalogues, brochures, trade literature, price lists, websites or other similar published materials are issued or published only for the purpose of giving an approximate idea of the Works described in them and will not form part of the Contract.
- 3.9 Any purchase order which has been accepted by George Fischer in accordance with clause 3.6 may only be amended, cancelled, postponed or varied by the Customer with the prior written consent of George Fischer and on terms that the Customer will indemnify George Fischer in full against all losses (including but not limited to loss of profit), costs, damages, charges and expenses incurred (directly or indirectly) by George Fischer as a result of such amendment, cancellation, postponement or variation.
- ## 4 DELIVERY
- 4.1 Any times specified or agreed by George Fischer for the delivery of the Goods and/or performance of the Services are given in good faith but are an estimate only. If no time is specified or agreed by George Fischer delivery will take place within a reasonable time. Time will not be of the essence for the delivery of the Goods or for the performance of the Services.
- 4.2 George Fischer will use its reasonable endeavours to deliver the Goods and perform the Services within the times referred to in clause 4.1 but George Fischer will not be liable for the consequences of any delay, or failure to deliver or perform, if (a) the duration of the delay is not substantial, or (b) the delay or failure is due to any circumstances beyond George Fischer's reasonable control or of an unexpected or exceptional nature or (c) the delay results from or is contributed to by any act or omission of the Customer.

- 4.3 Subject to the provisions of clause 4.4, delivery will be deemed to take place when the Works are delivered to the Customer at such place as the parties may agree from time to time, except that delivery to a carrier for the purpose of transmission to the Customer will be deemed to be delivery to the Customer and sections 32(2) and (3) of the Sale of Goods Act 1979 will not apply.
- 4.4 If George Fischer agrees to permit the Customer to collect the Works from George Fischer's place of business then delivery will be deemed to take place when George Fischer notifies the Customer that the Works are ready for collection and unless otherwise agreed in writing the Customer will collect the Works within 3 working days of the issue of such notice.
- 4.5 George Fischer will use its reasonable endeavours to ensure where necessary that the Works will be packed so as to be adequately protected against damage in normal conditions of transit of usual duration. George Fischer will make such arrangements for the carriage and insurance of the Works as it agrees with the Customer.
- 4.6 George Fischer may deliver the Goods and perform the Services in instalments. Deliveries of further instalments may be withheld until the Works comprised in earlier instalments have been paid for in full. Default by George Fischer (howsoever caused) in respect of one or more instalments will not entitle the Customer to terminate any other instalment, the relevant Contract or any other contract between the parties.
- 4.7 In the event of any delay in the delivery of any Goods or the performance of any Services which are attributable (in whole or in part) to the Customer's acts or omissions then:
- delivery of the relevant Goods or performance of the relevant Services (as the case may be) will be deemed to have taken place at the time at which but for such delay or delays such delivery or performance would have taken place and any extra costs incurred as a result of such delay or delays will be added to the Contract price and will be payable by the Customer; and
  - George Fischer may sell such Goods 28 days after such delay and deduct any monies payable to George Fischer by the Customer from the sale proceeds and account to the Customer for any excess or charge the Customer for any shortfall.
- 4.8 Where the Works are to be supplied from stock such supply is subject to the availability of the stock.
- 4.9 The Customer shall examine all Goods within 14 days following delivery. Subject to clause 9.2, George Fischer will not be liable for any shortages in or non-delivery of the Works (even if caused by George Fischer's negligence) unless the same is notified in writing by the Customer to George Fischer (together with all relevant details) within 14 days of the actual or anticipated date of delivery (as appropriate). Subject to such notice being provided George Fischer will, if it is reasonably satisfied that any Works have not been delivered as a result of George Fischer's fault (in its sole discretion) either arrange for delivery as soon as reasonably possible or give credit (at the pro rata Contract price) to the Customer for such Works. Any shortages in or non-delivery of part of the Works will not affect the Contract in respect of the other parts of the Works or any other contract.
- 4.10 If George Fischer complies with clause 4.9 it will (subject to clause 9.2) have no further liability (in contract, tort (including but not limited to negligence) or otherwise) for such shortages or non-delivery.
- 4.11 Whilst George Fischer will use reasonable endeavours to supply the exact quantity of the Works ordered by the Customer, George Fischer may supply and the Customer will accept up to 10% more or less than the exact quantity ordered. A pro rata increase or reduction in the Contract price (as the case may be) will be made to cover any such variation.
- 4.12 The Customer (at its own expense) will ensure that the place where delivery of the Goods or performance of the Services is to take place (excluding in each case any premises of George Fischer) is adequate and appropriate for such delivery or performance and will provide such access, equipment, facilities, protection, manual labour and information as may be required to enable George Fischer to perform its obligations under the Contract.
- ## 5 RISK AND OWNERSHIP
- 5.1 Unless otherwise agreed in writing the Works are at the risk of the Customer from the time of delivery or deemed delivery to the Customer (as appropriate) and loading and off loading (as appropriate) will be at the Customer's risk. Section 20(2) of the Sale of Goods Act 1979 will not apply.
- 5.2 Notwithstanding that risk in the Works will pass to the Customer in accordance with the provisions of clause 5.1, ownership of the Works (both legal and equitable) will only pass to the Customer (other than when ownership is properly vested in some other person by the operation of any statute) when George Fischer has received in full (in cash or cleared funds) all monies due to it from the Customer:
- in respect of the Works; and
  - all other sums which are or which become due to George Fischer from the Customer on any account.
- 5.3 Until ownership of the Works has passed to the Customer under clause 5.2, the Customer will:
- hold the Works on a fiduciary basis as George Fischer's bailee;
  - keep the Works free from any charge, lien or other encumbrance;
  - store the Works (at no cost to George Fischer) separately from all other materials of the Customer or any third party in such a way that they remain readily identifiable as George Fischer's property;
  - not destroy, deface or obscure any identifying mark on the Works or their packaging;
  - maintain the Works in a satisfactory condition, insured on George Fischer's behalf for their full price against all risks to the reasonable satisfaction of George Fischer and on request provide a copy of such policy of insurance and proof that the premiums have been paid to George Fischer;
  - hold all proceeds of the insurance referred to in clause 5.3(e) on trust for George Fischer and not mix it with any other money or pay the proceeds into any overdrawn bank account;
  - not attach the Works to any real property without George Fischer's consent; and
  - notify George Fischer immediately if it becomes subject to any of the events listed in clause 16.2.
- 5.4 The Customer may resell, use or otherwise dispose of the Works before ownership has passed to it only if any such sale, use or disposition will be effected in the ordinary course of the Customer's business and will be a sale, use or disposition of George Fischer's property on the Customer's own behalf and the Customer will deal as principal.
- 5.5 George Fischer may while the owner of the Works (and without prejudice to any other rights it may have under or by virtue of these Conditions) demand the immediate return of the Works at any time and the Customer will forthwith comply with such demand and bear the expenses for such return.
- 5.6 The Customer grants or, where applicable, shall procure that any relevant third party grants to George Fischer (or its successors in title for the Works) and their respective employees and agents an irrevocable licence to enter at any time any premises where the Works are or may be situated for the purpose of inspecting or removing any such

**GEORGE FISCHER SALES LIMITED ("George Fischer")  
CONDITIONS OF SALE (FOR GOODS AND SERVICES)**

- Works the ownership in which has remained with George Fischer (or such successor in title).
- 5.7 George Fischer will be entitled to recover payment for the Works notwithstanding that ownership of any of the Works has not passed from George Fischer.
- 5.8 The Works will be deemed sold or used by the Customer, in the order in which they are delivered to the Customer by George Fischer.
- 6 CUSTOMER'S GENERAL OBLIGATIONS**
- 6.1 The Customer shall:
- (a) co-operate with George Fischer in all matters relating to the Contract;
  - (b) provide George Fischer with such information and materials as George Fischer may reasonably require to comply with its obligations under the Contract, and shall ensure that such information is accurate in all material respects;
  - (c) obtain and maintain all necessary licences, permissions and consents which may be required for Customer's purchase, transportation and use of the Goods and as may be required for George Fischer to provide the Services (except where and to the extent that the Parties agree in writing that this is George Fischer's responsibility); and
  - (d) keep and maintain all materials, equipment, documents and other property of George Fischer at the Customer's premises in safe custody and in good condition and not dispose of or use the same other than in accordance with George Fischer's written instructions or authorisation.
- 7 PRICE AND PAYMENT**
- 7.1 The price stated in the Contract is based on the cost to George Fischer of materials, fuel, power, transport, taxes, duties, services, labour and all other costs at the date of George Fischer's quotation, acknowledgement of order or supply (whichever is earlier). If at the date of delivery or deemed delivery or performance of the Works, there has been any increase in all or any of such costs, or there has been any agreed change to the Customer Design Requirements, the price payable for the relevant Works may be increased by George Fischer accordingly.
- 7.2 Quotations given in a currency other than sterling are based on the rate of exchange at the time of quoting and (unless otherwise agreed in writing between the parties) the price may be subject to revision if any different rate of exchange is ruling at the date of invoice.
- 7.3 Unless otherwise agreed the price for the Works is exclusive of any value added tax (and any other tax or duty relating to the manufacture, transportation, sale or delivery of the Works) and any costs or charges in relation to export and/or import, packaging, loading, unloading, carriage and insurance. Such costs and expenses will be paid by the Customer in addition to the price for the Works at the same time that it is due to pay for the Works.
- 7.4 Where George Fischer agrees (in its discretion) to bring forward the date of delivery or performance of any Works at the Customer's request any overtime or other additional costs reasonably incurred by George Fischer shall be charged to the Customer in addition to the Contract price.
- 7.5 George Fischer may invoice the Customer for the Goods at any time after the delivery of the Goods or the delivery of any instalment (as appropriate). In respect of the Services George Fischer shall be entitled to invoice the Customer at any time after performance of the relevant services. If any delivery or performance is postponed at the request or by the default of the Customer then George Fischer may submit its invoice at any time after the Goods are ready or would have been ready for delivery or the Services would have been performed (as appropriate) in the ordinary course but for the request or default on the part of the Customer.
- 7.6 Customers who have been granted by George Fischer (in its sole discretion) a credit account facility will pay the price within 30 days of the date of the relevant invoice. George Fischer may (in its sole discretion) amend the terms of or withdraw such credit account facility at any time without notice with immediate effect and on such withdrawal all amounts due or accruing to George Fischer under the Contract will become immediately payable despite any other provision of these Conditions.
- 7.7 Customers who have not been granted a credit account facility will pay the price 5 working days prior to delivery or performance (as the case may be) of the Works.
- 7.8 No payment will be deemed to have been received until George Fischer has received cleared funds.
- 7.9 Time for payment by the Customer will be of the essence of the Contract and the Customer will indemnify George Fischer against all expenses and legal costs incurred by George Fischer in recovering overdue amounts.
- 7.10 All payments payable to George Fischer under the Contract will become due immediately on termination of this Contract despite any other provision of these Conditions.
- 7.11 The Customer will make all payments due under the Contract without any deduction whether by way of set-off, counterclaim, discount, abatement or otherwise unless the Customer has a valid court order requiring an amount equal to such deduction to be paid by George Fischer to the Customer, or such deduction is otherwise required to be permitted by law.
- 7.12 If the Customer fails to pay George Fischer any sum due pursuant to the Contract the Customer will be liable to pay interest to George Fischer on such sum from the due date for payment at an annual rate of 4% above the base lending rate of HSBC Bank plc from time to time accruing on a daily basis until payment is made in full (whether before or after any judgement). In the alternative, George Fischer in its absolute discretion, reserves the right to claim interest and compensation payments under the Late Payment of Commercial Debts (Interest) Act 1998.
- 7.13 Without prejudice to the provisions of clause 7.12, if the Customer fails or George Fischer reasonably believes that the Customer will fail to pay for the Works when due George Fischer may demand payment of all outstanding balances whether due or not, treat the Contract as repudiated by the Customer or suspend any future performance of the Contract or any other contract with the Customer until all overdue sums have been paid.
- 7.14 If George Fischer provides for or arranges for any non-cash awards and/or incentives for the benefit of the Customer (including but not limited to shopping vouchers), the Customer agrees that it is solely responsible for the payment of any and all applicable taxes, duties or levies which may be or become payable in respect of such non-cash award and/or incentive (excluding Class 1A National Insurance, which shall be paid by George Fischer), and the Customer agrees that it will keep George Fischer fully indemnified in respect of any demand made for any such tax, duties or levies, and any fines, penalties or interest incurred by George Fischer from time to time in respect of such non-cash award and/or incentive.
- 8 QUALITY**
- 8.1 George Fischer warrants (subject to the provisions of this clause 8) that:
- (a) on delivery of the Goods and for a period of 12 months from the date of delivery (the "Warranty Period"), the Goods will comply with the relevant Standard Specification or Customer Design Requirements (as appropriate); and
  - (b) the Services will be performed and Deliverables prepared with reasonable skill and care by properly qualified and experienced persons.
- 8.2 George Fischer will not be liable for any defect in Works unless:
- (a) the Customer gives written notice of the defect to George Fischer within 28 days of the date when the Customer discovers or ought reasonably to have discovered the defect and in any event, on or before expiry of the Warranty Period;
  - (b) the defect is as a result of damage in transit, and the Customer gives written notice of the defect to the carrier in the manner and within the appropriate time limit as set out in the carrier's terms of business; and
  - (c) George Fischer is given a reasonable opportunity after receiving such notice to examine such Works and the Customer (if requested to do so by George Fischer) returns such Works to George Fischer's place of business (at the Customer's cost) for the examination to take place there.
- 8.3 George Fischer will not be liable for any defects in any Works, where and to the extent that:
- (a) the defect arises from the Customer's Property or as a result of the Customer's negligence;
  - (b) the defect arises as a result of fair wear and tear, misuse, wilful damage, or abnormal working conditions;
  - (c) the defect arises as a result of any parts, materials or equipment not manufactured or workmanship not performed by George Fischer;
  - (d) the defect arises as a result of George Fischer following the Customer Design Requirements;
  - (e) the defect arises out of any deviation from the Customer's Design Requirements to ensure that the relevant Custom Product complies with applicable legal or regulatory standards;
  - (f) the Customer makes any further use of such Works after giving written notice of the defect;
  - (g) the defect arises because the Customer has failed to follow George Fischer's instructions (whether oral or in writing) as to the storage, assembly, installation, commissioning, use, processing, handling or maintenance of the Works or (if there are none) good trade practice;
  - (h) the defect arises as a result of any installation, testing or commissioning of the Works performed by the Customer or any third party; or
  - (i) the defect arises as a result of any alteration, servicing or repair of the Works not made by George Fischer and without the written consent of George Fischer.
- 8.4 Subject to clauses 8.2 and 8.3 in the event that any of the Works do not conform with any of the warranties set out in clause 8.1 George Fischer will at its option and cost repair or replace the relevant Goods (or the defective part), re-perform the relevant Services (or the defective part) or refund the price of such Works or the defective part at the pro rata Contract rate.
- 8.5 If George Fischer complies with clause 8.4 it will (subject to clause 9.2) have no further liability (in contract, tort (including but not limited to negligence) or otherwise) in respect of the defect in the Works.
- 8.6 Any Goods replaced by George Fischer or which George Fischer has agreed to replace in accordance with the provisions of clause 8.4 will belong to George Fischer and any repaired or replacement Goods will be guaranteed on these terms for the unexpired portion of the original Warranty Period.
- 9 LIMITATION AND EXCLUSION OF LIABILITY**
- THE PRICES CHARGED FOR THE WORKS ARE BASED STRICTLY ON THE UNDERSTANDING OF ACCEPTANCE BY THE CUSTOMER OF THE PROVISIONS IN THE CONTRACT FOR THE LIMITATION OF GEORGE FISCHER'S LIABILITY. SHOULD THE CUSTOMER WISH GEORGE FISCHER TO ACCEPT ADDITIONAL LIABILITY THIS MAY BE DISCUSSED BETWEEN THE PARTIES AND THE PRICE MAY BE INCREASED ACCORDINGLY.
- 9.1 All warranties, conditions and other terms implied by statute, common law, trade, practice, custom or course of dealing (except for the conditions implied by section 12 of the Sale of Goods Act 1979 and section 2 of the Supply of Goods and Services Act 1982) are, to the fullest extent permitted by law, excluded from the Contract.
- 9.2 Nothing in these Conditions excludes or limits the liability of George Fischer for fraud, (including fraudulent misrepresentation) or for any death or personal injury caused by George Fischer's negligence or for any breach of the conditions implied by section 12 of the Sale of Goods Act 1979 and section 2 of the Supply of Goods and Services Act 1982 or any other matter in respect of which it would be unlawful to exclude or restrict liability. THE CUSTOMER'S ATTENTION IS IN PARTICULAR DRAWN TO THE PROVISIONS OF CLAUSES 9.3 and 9.4.
- 9.3 Subject to clause 9.2, George Fischer will not be liable to the Customer in contract, tort (including but not limited to negligence), misrepresentation or otherwise:
- (a) for any economic loss of any kind (including but not limited to direct or indirect loss of profit, business, contracts, revenue or anticipated savings);
  - (b) for any direct or indirect damage to the Customer's reputation or goodwill;
  - (c) for any direct or indirect product recall costs; or
  - (d) for any special, indirect or consequential loss or damage (even if George Fischer has been advised of such loss or damage),
- in each case, arising out of or in connection with the Contract.
- 9.4 Subject to the provisions of clauses 9.2 and 10.2, George Fischer's total liability to the Customer in respect of all other liabilities arising under or in connection with the Contract, whether in contract, tort (including but not limited to negligence), breach of statutory duty, or otherwise (including but not limited to losses caused by a deliberate breach of the Contract by George Fischer, its employees, agents or subcontractors) shall not exceed the price of the Goods or Services which are the subject of the claim or, if the claim does not relate to any particular Goods or Services, the total price paid, payable or that would have become payable under the Contract.
- 10 THE CUSTOMER'S PROPERTY**
- 10.1 While George Fischer will take reasonable care of the Customer's Property whilst it is in George Fischer's possession, control or custody the Customer's Property will (unless otherwise agreed in writing) remain at the Customer's risk and all replacements and alterations of and repairs to the Customer's Property will be the Customer's responsibility.
- 10.2 George Fischer will not be liable for any loss or damage to the Customer's Property unless such loss or damage arises as a direct result of George Fischer's negligence or wilful misconduct. Where George Fischer is liable under this clause 10.2 George Fischer's liability to the Customer will be limited to £100,000.
- 10.3 The Customer will ensure that the Customer's Property is in good condition and suitable for use by George Fischer in the performance of the Contract and while George Fischer will use reasonable endeavours to verify any relevant aspects of the Customer's Property no responsibility is accepted by George Fischer for its accuracy.
- 10.4 Any defect in the Works or any part of them which is due in whole or in part to the Customer's Property will not entitle the Customer to terminate the Contract, reject the Works, make any deductions from the Contract price or claim damages in respect of such defect.
- 10.5 The Customer will keep George Fischer indemnified in full against any and all liabilities, demands, injuries, claims, actions, costs (including but not limited to legal costs), expenses, proceedings, judgments, awards, sanctions, fines, damages and losses

## GEORGE FISCHER SALES LIMITED (“George Fischer”) CONDITIONS OF SALE (FOR GOODS AND SERVICES)

- suffered or incurred, and settlements made by George Fischer as a result of or in connection with the use by George Fischer of the Customer's Property unless and to the extent that such liability, loss, damage, injury, claim, action, demand, expense or proceeding is the result of George Fischer's negligent acts or omissions.
- 10.6 The Customer shall defend and indemnify George Fischer from and against any and all liabilities, demands, injuries, claims, actions, costs (including but not limited to legal costs), expenses, proceedings, judgments, awards, sanctions, fines, damages and losses suffered or incurred, and settlements made by George Fischer in connection with any claim made against George Fischer arising out of, related to or in connection with the Customer's Design Requirements or their use as anticipated under the Contract.
- 11 TOLERANCES AND TESTS**
- 11.1 Without prejudice to clause 4.11, unless otherwise agreed in writing gauges, weights, chemical composition and analysis, quantities and sizes will, so far as possible, be adhered to but reasonable excesses and deficiencies will be accepted by the Customer, who will not be entitled to reject any Works on the ground that they are not precisely as specified (in the event of any such reasonable excesses or deficiencies).
- 11.2 An additional charge will be made for all tests, test pieces and inspections required by the Customer and agreed by George Fischer, unless otherwise agreed in writing. All tests and inspections will take place under George Fischer's standard testing arrangements, and such tests will be final (except in the case of manifest error or fraud). All tests are subject to analytical tolerances.
- 11.3 The Customer may attend (at its own cost) all tests provided that it notifies George Fischer in writing of its intention to do so. The Customer will then be given not less than 5 working days' prior notice of the proposed date and time of any test and, if the Customer fails to attend, the test will proceed in its absence although it will be deemed to have been made in its presence.
- 12 OWNERSHIP OF TOOLING**
- 12.1 Where patterns, dies, tools, drawings and equipment are not supplied by the Customer, only those which are specially made by George Fischer and separately charged to the Customer in full, will, become the property of the Customer, and such property shall pass in accordance with clause 5.2 following payment in full for them by the Customer.
- 12.2 George Fischer reserves the right to destroy or otherwise dispose of patterns, dies, tools, drawings and equipment in its possession, control or custody (whether or not the property of the Customer) from which the Customer has not required any Goods to be made or Services provided for a period of 12 months or more.
- 13 PACKING CASES AND PACKING MATERIALS**
- 13.1 Unless otherwise agreed in writing, there will be no additional charges for packing cases and packing materials but, where stated to be returnable, will be returned to George Fischer in good condition, within one month of receipt by the Customer. Where not returnable, the Customer will dispose of all packing in accordance with all regulations (whether statutory or otherwise) relating to the protection of the environment.
- 14 CONFIDENTIALITY**
- 14.1 The Customer will keep confidential all technical data, commercial information, know how, specifications, inventions, processes, initiatives and other information which is of a confidential nature and which has been disclosed or made available to the Customer by George Fischer and/or any member of the George Fischer group and/or its agents, and any other confidential information concerning the business of George Fischer and/or any member of the George Fischer group or its or their products ("Confidential Information").
- 14.2 The Customer will restrict disclosure of the Confidential Information to such of its employees, agents, professional advisers or subcontractors as reasonably need to know the same and will ensure that such employees, agents, professional advisers or subcontractors are subject to equivalent obligations of confidentiality as bind the Customer.
- 14.3 The Customer will not without the prior written consent of George Fischer publish or disclose the Confidential Information to any third party or make any use of the Confidential Information except to the extent necessary to implement the Contract.
- 15 INTELLECTUAL PROPERTY**
- 15.1 The Customer will keep George Fischer indemnified in full against any and all liabilities, demands, injuries, claims, actions, costs (including but not limited to legal costs), expenses, proceedings, judgments, awards, sanctions, fines, damages and losses suffered or incurred, and settlements made in respect of any infringement or alleged infringement of any IPR resulting from any use by George Fischer of the Customer's Property, the Customer Design Requirements or any compliance by George Fischer with the Customer's instructions, whether express or implied.
- 15.2 Unless otherwise agreed in writing, ownership in all IPR subsisting in, resulting from or relating to the Works or any associated plans, descriptions, blue prints, designs, technical information, drawings, documents or specifications including without limitation the Custom Products (except where and to the extent these comprise the Customer's Property) will vest in George Fischer. If the Customer in any way acquires any such rights it will promptly inform George Fischer and take such steps as George Fischer may reasonably require to assign such rights or vest such title in George Fischer.
- 15.3 The Customer grants to George Fischer a non-exclusive, worldwide, perpetual, non-terminable, irrevocable, royalty-free licence to use, reproduce, modify and develop all IPRs which subsist in the Customer's Design Requirements or any other confidential information of the Customer disclosed to George Fischer for the purposes of manufacturing and supplying the Goods, providing the Services and otherwise performing its obligations under the Contract.
- 15.4 Nothing in these Conditions will be construed as any representation or warranty by George Fischer that the design, manufacture, use or sale of the Works is not an infringement of any third party IPRs.
- 16 TERMINATION**
- 16.1 George Fischer may terminate the Contract (and all other contracts between George Fischer and the Customer) immediately on written notice to the Customer if:
- the Customer fails to pay the price on the due date;
  - the Customer is in breach of any term of the Contract and such breach is incapable of remedy;
  - the Customer is in breach of any term of the Contract and has failed to remedy such breach within 28 days of receipt of written notice specifying the breach and requiring it to be remedied; or
  - there is a material change in the ownership or control of the Customer.
- 16.2 Without limiting its other rights or remedies, George Fischer may terminate the Contract or suspend performance of its obligations with immediate effect by giving written notice to the Customer if the Customer:
- is unable or admits inability to pay or suspends payment of its debts as they fall due;
  - any legal proceedings or other procedure or step is taken in relation to the indebtedness of the Customer including, without limitation:
    - a composition, compromise, assignment or arrangement with any creditor (or any proposal for or negotiation of any of the same);
    - the appointment of a liquidator, receiver, administrator, administrative receiver or other similar officer;
- an application, petition, notice, order or resolution for the winding-up, dissolution, administration, liquidation or reorganisation (by way of voluntary arrangement, scheme of arrangement or otherwise); or
  - an enforcement of any security over any assets;
- (c) the Customer ceases or suspends or threatens to cease or suspend the conduct of all or substantially all of its business; or
- (d) suffers a deterioration in its financial position to such an extent that in George Fischer's opinion the Customer's capability to adequately fulfil its obligations under the Contract has been placed in jeopardy.
- 16.3 The termination of the Contract (howsoever arising) will be without prejudice to any rights and remedies which may have accrued to either party.
- 16.4 Any Conditions which expressly or impliedly have effect after termination or expiry will continue to be enforceable notwithstanding termination or expiry, including, without limitation, clauses 1, 3, 5, 6, 7, 8, 9, 10.2, 10.4, 10.5, 10.6, 12.2, 14, 15, 16.3, 16.4, 18, 19, 20 and 21.
- 17 EXPORT SALES**
- 17.1 Where the Works are supplied for export from the United Kingdom the provisions of this clause 17 will (subject to any special terms agreed in writing between the parties) apply despite any other provision of these Conditions.
- 17.2 The Uniform Laws on International Sales Act 1967 will not apply.
- 17.3 Unless otherwise agreed in writing the currency will be pounds sterling. The Customer will establish and maintain in favour of George Fischer an irrevocable and confirmed letter of credit in English with a UK clearing bank payable on drafts drawn at sight on presentation to the bank by George Fischer of a certified copy of George Fischer's invoice. All bank charges and other expenses in relation to the letter of credit will be borne by the Customer.
- 17.4 Unless otherwise agreed in writing Works will be sold C.I.F. (as defined in INCOTERMS 2010 Edition).
- 17.5 The Customer will be responsible for complying with and shall comply with any legislation or regulation governing the export of the Works:
- from the United Kingdom; and/or
  - where the Works are sourced from a country other than the United Kingdom, from such country and the importation of the Works into the country of destination and for payment of any relevant duties or taxes whether payable by the Customer or George Fischer.
- 17.6 Unless otherwise agreed in writing, there will be additional charges for packing cases and packing materials but, where stated to be returnable, will be credited in full on return to George Fischer's place of business (carriage paid) in good condition, within one month of receipt by the Customer. Where not returnable, the Customer will dispose of all packing in accordance with all regulations (whether statutory or otherwise) relating to the protection of the environment.
- 18 LIEN**
- George Fischer will have in respect of unpaid debts due to it from the Customer a general lien on all property of the Customer which is in George Fischer's possession for whatever reason and whether worked upon or not.
- 19 ASSIGNMENT AND SUBCONTRACTING**
- 19.1 The Customer will not without the prior written consent of George Fischer assign or transfer the Contract or any part of it to any other person.
- 19.2 George Fischer may without the prior written consent of the Customer assign, transfer or subcontract the Contract or any part of it to any other person.
- 20 COMPLIANCE**
- 20.1 The Customer shall, at all times, in its dealings with George Fischer and any third party with whom it deals in relation to this Contract, comply with:
- all applicable laws, regulations and sanctions relating to anti-bribery and anti-corruption, including but not limited to the Bribery Act 2010; and
  - George Fischer's Bribery Policy; and
  - all applicable competition and export/trade laws. The Customer will not, through any act or omission, cause George Fischer to be in breach of any such laws or regulations.
- 20.2 A breach of this clause 20 shall be considered a material breach which shall give George Fischer an immediate right to terminate this Contract without prejudice to its other rights and remedies.
- 21 GENERAL**
- 21.1 Each right or remedy of George Fischer under these Conditions is without prejudice to any other right or remedy which George Fischer may have under these Conditions or otherwise.
- 21.2 Any notice or document shall be deemed served, if delivered by hand, at the time of delivery, if posted, 48 hours after posting and if sent by facsimile transmission, at the time of transmission. George Fischer may also send a notice or document by electronic communication in an e-mail address notified to George Fischer by the Customer. Such notice or document shall be deemed served if sent by e-mail at the time of sending, unless George Fischer receives a notification that such e-mail has not been delivered.
- 21.3 The illegality, invalidity or unenforceability of any provision of these Conditions will not affect the legality, validity or unenforceability of any other provisions of these Conditions.
- 21.4 Failure or delay by either party in exercising any right or remedy provided by the Contract or by law will not be construed as a waiver of such right or remedy or a waiver of any other right or remedy.
- 21.5 A person who is not a party to the Contract will have no right under the Contracts (Rights of Third Parties) Act 1999 to enforce any term of the Contract. This clause 21.5 does not affect any right or remedy of any person which exists or is available otherwise than pursuant to that Act.
- 21.6 The Customer agrees that it will have no remedy in respect of any untrue statement innocently or negligently made by or on behalf of George Fischer prior to the Contract upon which the Customer relied in entering into the Contract whether such statement was made orally or in writing unless the statement has been expressly agreed in writing by a director of George Fischer and/or the statement has been expressly incorporated in writing into the Contract.
- 21.7 George Fischer shall not be in breach of these Conditions or otherwise liable to the Customer by reason of any delay in performance or non-performance of any of its obligations due to any circumstances outside George Fischer's reasonable control.
- 21.8 The Contract and any dispute or claim arising out of or in connection with it or its subject matter or formation (whether or not such dispute or claim is contractual) shall be governed by, and construed in accordance with, English law.
- 21.9 The Parties irrevocably submit to the exclusive jurisdiction of the courts of England to settle any claim or dispute that arises out of or in connection with the Contract (whether or not such dispute is contractual).

# Worldwide at Home

Our sales companies and representatives

[www.gfps.com/uk](http://www.gfps.com/uk)

## Argentina / Southern South America

Georg Fischer Central Plastics  
Sudamérica S.R.L.  
Buenos Aires, Argentina  
Phone +54 11 4512 02 90  
gfcentral.ps.ar@georgfischer.com  
www.gfps.com/ar

## Australia

George Fischer Pty Ltd  
Riverwood NSW 2210 Australia  
Phone +61 (0) 2 9502 8000  
australia.ps@georgfischer.com  
www.gfps.com/au

## Austria

Georg Fischer  
Rohrleitungssysteme GmbH  
3130 Herzogenburg  
Phone +43 (0) 2782 856 43-0  
austria.ps@georgfischer.com  
www.gfps.com/at

## Belgium / Luxembourg

Georg Fischer NV/SA  
1070 Bruxelles/Brüssel  
Phone +32 (0) 2 556 40 20  
be.ps@georgfischer.com  
www.gfps.com/be

## Brazil

Georg Fischer Sist. de Tub. Ltda.  
04571-020 São Paulo/SP  
Phone +55 (0)11 5525 1311  
br.ps@georgfischer.com  
www.gfps.com/br

## Canada

Georg Fischer Piping Systems Ltd  
Mississauga, ON L5T 2B2  
Phone +1 (905) 670 8005  
Fax +1 (905) 670 8513  
ca.ps@georgfischer.com  
www.gfps.com/ca

## China

Georg Fischer Piping Systems Ltd  
Shanghai 201319  
Phone +86 21 3899 3899  
china.ps@georgfischer.com  
www.gfps.com/cn

## Denmark / Iceland

Georg Fischer A/S  
2630 Taastrup  
Phone +45 (0) 70 22 19 75  
info.dk.ps@georgfischer.com  
www.gfps.com/dk

## Finland

Georg Fischer AB  
01510 VANTAA  
Phone +358 (0) 9 586 58 25  
Fax +358 (0) 9 586 58 29  
info.fi.ps@georgfischer.com  
www.gfps.com/fi

## France

Georg Fischer SAS  
95932 Roissy Charles de Gaulle  
Cedex  
Phone +33 (0) 1 41 84 68 84  
fr.ps@georgfischer.com  
www.gfps.com/fr

## Germany

Georg Fischer GmbH  
73095 Albershausen  
Phone +49 (0) 7161 302-0  
info.de.ps@georgfischer.com  
www.gfps.com/de

## India

Georg Fischer Piping Systems Ltd  
400 083 Mumbai  
Phone +91 224007 2001  
branchoffice@georgfischer.com  
www.gfps.com/in

## Indonesia

George Fischer Pte Ltd –  
Representative Office  
Phone +62 21 2900 8564  
Fax +62 21 2900 8566  
sgp.ps@georgfischer.com  
www.gfps.com/sg

## Italy

Georg Fischer S.p.A.  
20063 Cernusco S/N (MI)  
Phone +39 02 921 861  
it.ps@georgfischer.com  
www.gfps.com/it

## Japan

Georg Fischer Ltd  
556-0011 Osaka  
Phone +81 (0) 6 6635 2691  
jp.ps@georgfischer.com  
www.gfps.com/jp

## Korea

GF Piping Systems  
Georg Fischer Korea Co., Ltd.  
Unit 2501, U-Tower  
120 HeungdeokJungang-ro  
(Yeongdeok-dong)  
Giheung-gu, Yongin-si, Gyeonggi-do,  
Korea  
Phone: +82 31 8017 1450  
Fax: +82 31 217 1454  
kor.ps@georgfischer.com  
www.gfps.com/kr

## Malaysia

George Fischer (M) Sdn. Bhd.  
40460 Shah Alam, Selangor Darul  
Ehsan  
Phone +60 (0) 3 5122 5585  
Fax +603 5122 5575  
my.ps@georgfischer.com  
www.gfps.com/my

## Mexico / Northern Latin America

Georg Fischer S.A. de C.V.  
Apodaca, Nuevo Leon  
CP66636 Mexico  
Phone +52 (81) 1340 8586  
Fax +52 (81) 1522 8906  
mx.ps@georgfischer.com  
www.gfps.com/mx

## Middle East

Georg Fischer  
Piping Systems (Switzerland) Ltd  
Dubai, United Arab Emirates  
Phone +971 4 289 49 60  
gcc.ps@georgfischer.com  
www.gfps.com/int

## Netherlands

Georg Fischer N.V.  
8161 PA Epe  
Phone +31 (0) 578 678 222  
nl.ps@georgfischer.com  
www.gfps.com/nl

## Norway

Georg Fischer AS  
1351 Rud  
Phone +47 67 18 29 00  
no.ps@georgfischer.com  
www.gfps.com/no

## Philippines

Georg Fischer Pte Ltd  
Representative Office  
Phone +632 571 2365  
Fax +632 571 2368  
sgp.ps@georgfischer.com  
www.gfps.com/sg

## Poland

Georg Fischer Sp. z o.o.  
05-090 Sekocin Nowy  
Phone +48 (0) 22 31 31 0 50  
poland.ps@georgfischer.com  
www.gfps.com/pl

## Romania

Georg Fischer  
Piping Systems (Switzerland) Ltd  
020257 Bucharest - Sector 2  
Phone +40 (0) 21 230 53 80  
ro.ps@georgfischer.com  
www.gfps.com/int

## Russia

Georg Fischer  
Piping Systems (Switzerland) Ltd  
Moscow 125040  
Phone +7 495 748 11 44  
ru.ps@georgfischer.com  
www.gfps.com/ru

## Singapore

George Fischer Pte Ltd  
11 Tampines Street 92, #04-01/07  
528 872 Singapore  
Phone +65 6747 0611  
Fax +65 6747 0577  
sgp.ps@georgfischer.com  
www.gfps.com/sg

## Spain / Portugal

Georg Fischer S.A.  
28046 Madrid  
Phone +34 (0) 91 781 98 90  
es.ps@georgfischer.com  
www.gfps.com/es

## Sweden

Georg Fischer AB  
117 43 Stockholm  
Phone +46 (0) 8 506 775 00  
info.se.ps@georgfischer.com  
www.gfps.com/se

## Switzerland

Georg Fischer  
Rohrleitungssysteme (Schweiz) AG  
8201 Schaffhausen  
Phone +41 (0) 52 631 30 26  
ch.ps@georgfischer.com  
www.gfps.com/ch

## Taiwan

Georg Fischer Co., Ltd  
San Chung Dist., New Taipei City  
Phone +886 2 8512 2822  
Fax +886 2 8512 2823  
www.gfps.com/tw

## United Kingdom / Ireland

Georg Fischer Sales Limited  
Coventry, CV2 2ST  
Phone +44 (0) 2476 535 535  
uk.ps@georgfischer.com  
www.gfps.com/uk

## USA / Caribbean

Georg Fischer LLC  
9271 Jeronimo Road  
92618 Irvine, CA  
Phone +1 714 731 88 00  
Fax +1 714 731 62 01  
us.ps@georgfischer.com  
www.gfps.com/us

## International

Georg Fischer  
Piping Systems (Switzerland) Ltd  
8201 Schaffhausen/Switzerland  
Phone +41 (0) 52 631 30 03  
Fax +41 (0) 52 631 28 93  
info.export@georgfischer.com  
www.gfps.com/int

The technical data are not binding. They neither constitute expressly warranted characteristics nor guaranteed properties nor a guaranteed durability. They are subject to modification. Our General Terms of Sale apply.



20014L078 (11.16)

© Georg Fischer Piping Systems Ltd  
CH-8201 Schaffhausen/Switzerland, 2016  
Printed in the UK