

Bedienungs- und Montageanleitung
Instructions d'emploi et de montage
Istruzioni d'uso e montaggio
Operating- and installation
instructions

JRG Sanipex MT

4802.000

d16/d20/d25/d26/d32

Montagekoffer

D 1 – 12

Coffret de montage

F 13 – 27

Valigetta di montaggio

I 29 – 43

Fitter's toolkit

E 45 – 59



+GF+

JRG

Bedienungs- und Montageanleitung

Bitte lesen Sie die vorliegende Bedienungs- und Montageanleitung vor dem Gebrauch der Werkzeuge aufmerksam durch.

Der Montagevorgang gilt sinngemäss auch für JRG Sanipex PE-X Rohre.

Die eingesetzten Symbole bedeuten:



Warnung

Dieses Symbol weist auf eine Information hin, deren Nichtbeachtung zu umfangreichen Sachschäden führen kann. Die Sicherheitshinweise sind zu beachten.



Hinweis

Dieses Symbol weist auf eine Information hin, die wichtige Angaben hinsichtlich der Verwendung enthält. Das Nichtbefolgen kann zu Störungen führen.

Die Bedienungs- und Montageanleitung ist Bestandteil der **JRG Sanipex MT** Montagewerkzeuge. Sie ist im Montagekoffer aufzubewahren.



2

1

2

4

3

Aufbau der JRG Sanipex MT Aufweitzange

- 1 Führungsstift für Aufweitedorn
- 2 Klemmbacken
- 3 Arbeitshebel
- 4 Spannhebel

Montagekoffer d16+d20+d25+d26+d32, JRG Nr. 4802.000

Im Montagekoffer 4828.005 sind enthalten:

4805.000	Aufweitzange
4832.016	Ratschen-Drehmomentschlüssel d16
4832.020	Ratschen-Drehmomentschlüssel d20
4832.026	Ratschen-Drehmomentschlüssel d26
4832.032	Ratschen-Drehmomentschlüssel d32
4834.016	Konterschlüssel d16
4834.020	Konterschlüssel d20
4834.026	Konterschlüssel d26
4834.032	Konterschlüssel d32
4806.016	Handbiegeschablone d16
4806.020	Handbiegeschablone d20
4806.026	Handbiegeschablone d26 (optional)
4837.000	Kombischere d16/d20
4836.000	Rohrabschneider d16-d40
4838.000	Markierstift
4805.016	Klemmbacken d16 für Mehrschichtverbund- und PE-X Rohr
4805.020	Klemmbacken d20 für Mehrschichtverbund- und PE-X Rohr
4805.026	Klemmbacken d26 für Mehrschichtverbundrohr
4805.032	Klemmbacken d32 für Mehrschichtverbundrohr
4805.125	Klemmbacken d25 für PE-X Rohr
4804.116	Aufweitedorn d16 für Mehrschichtverbundrohr
4804.120	Aufweitedorn d20 für Mehrschichtverbundrohr
4804.126	Aufweitedorn d26 für Mehrschichtverbundrohr
4804.132	Aufweitedorn d32 für Mehrschichtverbundrohr
4804.216	Aufweitedorn d16 für PE-X Rohr
4804.220	Aufweitedorn d20 für PE-X Rohr
4804.225	Aufweitedorn d25 für PE-X Rohr
35 09 458 67	Bedienungs- und Montageanleitung

Einleitung

Die JRG Sanipex MT Montagewerkzeuge dienen ausschliesslich der Montage des JRG Sanipex MT Installationssystems und bedürfen, bei bestimmungsgemäsem Gebrauch, keiner weiteren Wartung.

Es dürfen nur JRG Sanipex MT Systemkomponenten mit diesem Werkzeug verarbeitet werden.

Die Werkzeuge dürfen nicht zweckentfremdet werden.

An den JRG Sanipex MT Werkzeugen dürfen keine Reparaturen oder Änderungen irgendwelcher Art vorgenommen werden.

Folgende Rohre können mit der JRG Sanipex MT Aufweitzange (JRG Nr. 4802.100) aufgeweitet werden:

4600.016 – .032	JRG Sanipex MT Rohr	d16–d32	schwarz, in Stangen, 5 m
4600.316 – .332	JRG Sanipex MT Rohr	d16–d32	schwarz, in Stangen, 3 m
4602.016 – .026	JRG Sanipex MT Rohr	d16–d26	weiss, in Ringen, mit Schutzrohr
4604.016 – .032	JRG Sanipex MT Rohr	d16–d32	weiss, in Ringen
4606.016 – .226	JRG Sanipex MT Rohr	d16–d26	weiss, in Ringen, isoliert
5706.016 – .025	JRG Sanipex Rohr	d16–d25	weiss, in Ringen, mit Schutzrohr
5707.016 – .025	JRG Sanipex Rohr	d16–d25	weiss, in Ringen
5708.016 – .025	JRG Sanipex Rohr	d16–d25	weiss, in Stangen, 6 m
5710.016 – .220	JRG Sanipex Rohr	d16/d20	weiss, in Ringen, isoliert
5716.016 – .020	JRG Sanipex Rohr	d16/d20	blau, in Ringen, mit Schutzrohr
5717.016 – .020	JRG Sanipex Rohr	d16/d20	blau, in Ringen

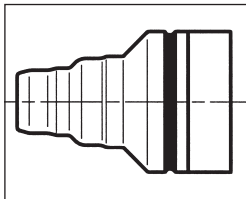

Auswählen der Aufweitdorne

- Für JRG Sanipex MT Rohre d16 x 2,25 Aufweitdorn mit einer Rille, schwarz
 Für JRG Sanipex MT Rohre d20 x 2,5 Aufweitdorn mit einer Rille, blau
 Für JRG Sanipex MT Rohre d26 x 3,0 Aufweitdorn mit einer Rille, rot
 Für JRG Sanipex MT Rohre d32 x 3,0 Aufweitdorn mit einer Rille, grün

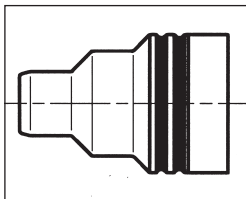

- Für JRG Sanipex PE-Xa und PE-Xc Rohre d16 x 2,2
 Aufweitdorn mit zwei Rillen, schwarz
 Für JRG Sanipex PE-Xa und PE-Xc Rohre d20 x 2,8
 Aufweitdorn mit zwei Rillen, blau

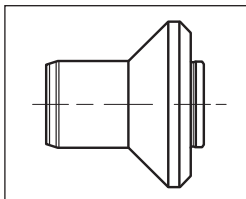

- Für JRG Sanipex PE-Xa und PE-Xc Rohre d25 x 3,5
 Aufweitdorn ohne Rillen, rot

Wechseln der Aufweitdorne

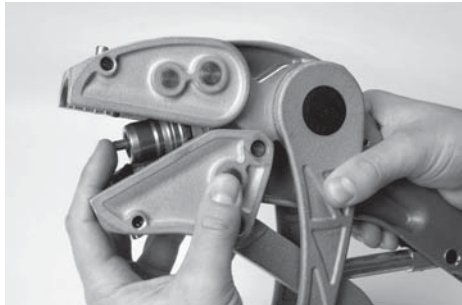

Arbeitshebel (3) etwas schliessen und in dieser Position festhalten. Dadurch wird der Haltemechanismus entlastet. Durch drücken des Führungstiftes (1) wird der Aufweitdorn (5) freigegeben. Arbeitshebel unverändert halten.

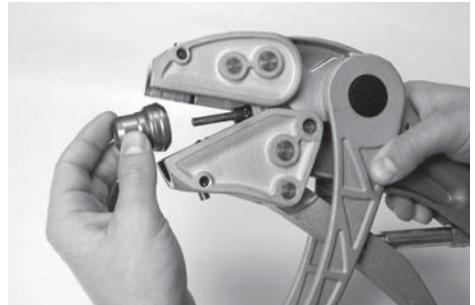

Gewünschter Aufweitdorn (5) über den Führungstift (1) schieben. Führungstift (1) drücken und den Aufweitdorn (5) bis an den Anschlag schieben. Der Wechsel des Aufweitdorns (5) ist abgeschlossen, wenn der Führungstift (1) losgelassen wird.

Wechseln der Klemmbacken

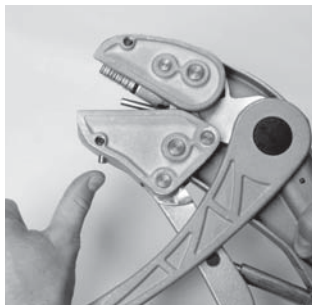

Durch drücken des oberen- oder unteren Lösestiftes wird die jeweilige Klemmbacke (2) freigegeben. Diese dann aus der Klemmbackenföhrung herausnehmen und die gewünschten Klemmbacken bis zum vollständigen Einrasten einsetzen.

Montagevorgang



JRG Sanipex MT Rohr mit der Kombischere (nur d16 und d20, JRG Nr. 4837) oder dem Rohrabschneider (JRG Nr. 4836) auf die gewünschte Länge ablängen.

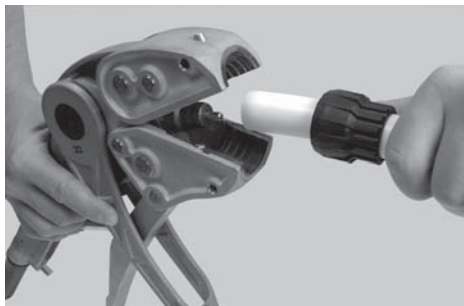

Nach dem Aufschieben der Überwurfmutter das JRG Sanipex MT Rohr bis zum Anschlag über den Aufweitdorn in die Aufweitzange einführen und Spannhebel (4) schliessen.



Hinweis **Richtiger Aufweitdorn**

Beachten Sie, dass der dem Rohr entsprechende Aufweitdorn (5) sowie die der Dimension entsprechenden Klemmbacken (2) eingesetzt sind.

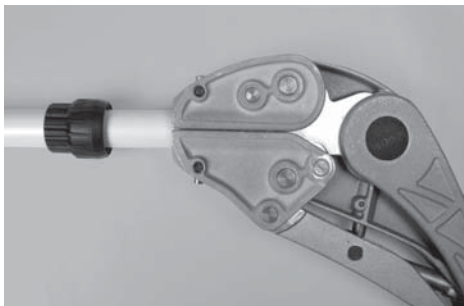

Aufweitvorgang durch Schliessen des Arbeitshebels (3) durchführen.



Hinweis
Aufweiten von JRG Sanipex
Rohren aus PE-X

Nach dem Aufweiten von flexiblen JRG Sanipex PE-X Rohren muss die Verbindung umgehend fertig erstellt werden.

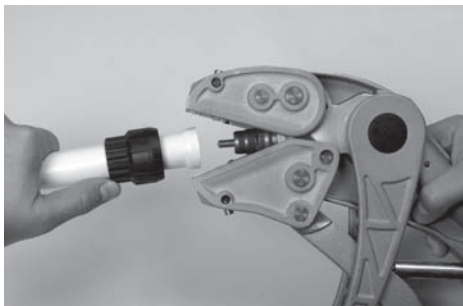

Arbeitshebel (3) öffnen und das aufgebördelte Rohrende wird freigegeben.



Hinweis

Sollte die Spanneinheit gelöst werden müssen, ohne dass eine Rohraufweitung durchgeführt wurde, so muss der Hebel vorsichtig geöffnet werden, da es sonst durch die hohe Öffnungsgeschwindigkeit zum unkontrollierten Herausfallen der Klembacken kommen könnte.

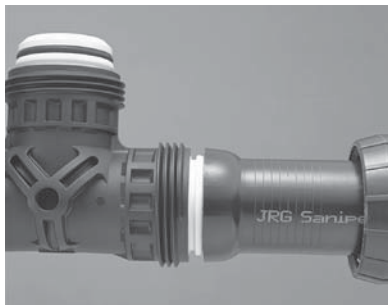
Klemmverbinder richtig

Kontrolle Aufweitvorgang.
Der O-Ring am Fitting muss durch den
Rohrbördel vollständig verdeckt sein.

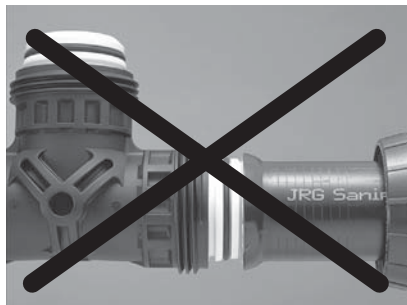

Warnung
Nicht korrekt ausgebildete Rohrbördel
Dürfen nicht nachgebördelt werden!

Klemmverbinder falsch



Aufgebördeltes JRG Sanipex MT Rohr auf den JRG Sanipex MT Fitting stecken. Überwurfmutter handsatt anziehen.



Überwurfmutter mit dem Ratschen-Drehmomentschlüssel (JRG Nr. 4832) anziehen. Zum Gegenhalten Richthülse (JRG Nr. 5777) oder Konterschlüssel (JRG Nr. 4834) verwenden.

**Warnung****Funktionsstörungen an Ratschen-Drehmomentschlüssel**

Bei allfälligen Funktionsstörungen oder bei Beschädigungen empfehlen wir den JRG Sanipex MT Ratschen-Drehmomentschlüssel im Austausch zu ersetzen.

**Warnung****Reparatur an Ratschen-Drehmomentschlüssel**

An JRG Sanipex MT Ratschen-Drehmomentschlüsseln dürfen keine Reparaturen vorgenommen werden.

**Hinweis****Ratschen-Drehmomentschlüssel**

Die JRG Sanipex MT Ratschen-Drehmomentschlüssel dienen ausschliesslich zum Anziehen von JRG Sanipex MT Bördelklemmverbindern.

Die entsprechenden Drehmomente sind vom Werk fest eingestellt und bedürfen, bei bestimmungsgemäsem Gebrauch, keiner weiteren Wartung.

Auswechseln des Schneiderades

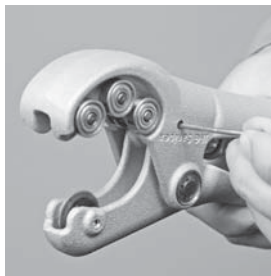

Rohrabschneider durch betätigen des Hebels vollständig öffnen. Arretierstift (z.B. Nagel Ø 3 mm) durch die Bohrung schieben. Dadurch bleibt der Rohrabschneider gesichert offen.



Mit einem Schraubenzieher die Zylinderschraube lösen. Das Schneidrad ersetzen. Schraube anziehen und Arretierstift entfernen.



Gefahr **Zurückschnellendes Schneidrad**

Gliedmassen können verletzt werden! Das Schneidrad darf nur bei arretiertem Hebel gewechselt werden.



Hinweis **Schneidrad-Achse**

Seit Januar 2002 werden nur noch abgesetzte Achsen verwendet. Diese Achsen ersetzen den Zylinderstift mit Buchse. Bei einem allfälligen Wechsel des Schneidrades muss, insofern noch nicht vorhanden, eine abgesetzte Achse eingesetzt werden.

Diese ist unter der Art. Nr. 16 003 15 erhältlich.



Biegen mit Handbiegeschablone



Rohrbogen anzeichnen.
Rohr in die Handbiegeschablone einführen.
Biegeanfang beachten.



Biegen des Rohrbogens.
Das Rohr muss beim Biegen
möglichst nahe der Biegelehre
entlang geführt werden.



Fertiger Rohrbogen aus der
Handbiegeschablone nehmen.

Bogenmass (cm)

d	90°	60°	45°	30°
16	5.6	3.2	2.3	1.5
20	7.0	4.0	2.9	1.9
26	9.1	5.3	3.8	2.4

**Hinweis****Überprüfung der Werkzeuge**

Ein gut funktionierendes, sauberes Werkzeug ist eine Grundvoraussetzung für eine dauerhaft dichte Verbindung.

Wir empfehlen deshalb, die Werkzeuge zu pflegen und diese regelmässig, einmal jährlich auf Ihre Funktionstüchtigkeit überprüfen zu lassen.

Unser Technischer Verkaufsberater steht Ihnen dazu gerne zur Verfügung.

**Achtung****Reparaturen an Werkzeugen**

An JRG Sanipex MT-Werkzeugen dürfen keine Reparaturen oder Veränderungen der Werkzeugeinstellungen vorgenommen werden. Bei Zuwiderhandlungen entfällt jegliche Gewährleistung und Haftung.

Bei defekten Werkzeugen kontaktieren Sie unseren Technischen Verkaufsberater.

Instructions d'emploi et de montage

JRG Sanipex MT

4802.000

d16/d20/d25/d26/d32

Coffret de montage

F 13 – 27



+GF+

JRG

Instructions d'emploi et de montage

Veillez lire attentivement les présentes instructions d'emploi et de montage avant d'utiliser les outils.

La procédure de montage s'applique par analogie aux tubes VPE JRG Sanipex.

Voici ce que signifient les symboles utilisés:



Avertissement

Ce symbole renvoie à une information dont le non-respect pourrait provoquer d'importants dommages matériels. Les indications de sécurité doivent être observées.



Note

Ce symbole renvoie à une information contenant des indications importantes sur l'emploi. Leur non-observation pourrait provoquer des dérangements.

Les instructions d'emploi et de montage font partie de l'outillage de montage **JRG Sanipex MT**. Elles doivent être conservées dans le coffret de montage.

**Description de
la pince à élargir
JRG Sanipex MT**

- 1 Tige de guidage pour mandrin d'élargissement
- 2 Mâchoires
- 3 Levier de travail
- 4 Levier de fixation

Coffret de montage d16+d20+d25+d26+d32, no JRG 4802.000

Le coffret de montage 4828.005 contient:

4805.000	Pince à élargir
4832.016	Clé dynamométrique à cliquet d16
4832.020	Clé dynamométrique à cliquet d20
4832.026	Clé dynamométrique à cliquet d26
4832.032	Clé dynamométrique à cliquet d32
4834.016	Contre-clé d16
4834.020	Contre-clé d20
4834.026	Contre-clé d26
4834.032	Contre-clé d32
4806.016	Chablon de cintrage à main d16
4806.020	Chablon de cintrage à main d20
4806.026	Chablon de cintrage à main d26 (optionnelle)
4837.000	Pince combinée d16/d20
4836.000	Coupe-tube d16-d40
4838.000	Marqueur
4805.016	Mâchoires d16 pour tube MT et PE-X
4805.020	Mâchoires d20 pour tube MT et PE-X
4805.026	Mâchoires d26 pour tube MT
4805.032	Mâchoires d32 pour tube MT
4805.125	Mâchoires d25 pour tube PE-X
4804.116	Mandrin d'élargissement d16 pour tube MT
4804.120	Mandrin d'élargissement d20 pour tube MT
4804.126	Mandrin d'élargissement d26 pour tube MT
4804.132	Mandrin d'élargissement d32 pour tube MT
4804.216	Mandrin d'élargissement d16 pour tube PE-X
4804.220	Mandrin d'élargissement d20 pour tube PE-X
4804.225	Mandrin d'élargissement d25 pour tube PE-X
35 09 458 67	Instructions d'emploi et de montage

Introduction

L'outillage de montage JRG Sanipex MT est exclusivement destiné au montage des systèmes sanitaires JRG Sanipex MT, si ils sont utilisés conformément, il ne requièrent aucun entretien particulier.

Les outils ne doivent être appliqués qu'à des composants du système JRG Sanipex MT.

Ces outils ne doivent pas être utilisés à d'autres fins.

Aucune réparation ni modification de quelque nature que ce soit ne peuvent être effectuées ou apportées aux outils composant l'outillage JRG Sanipex MT.

Les tubes suivant peuvent être sertis avec la pince à élargir JRG Sanipex MT (no JRG 4802.100):

4600.016 – .032	Tube JRG Sanipex MT	d16–d32	noir, en barres, 5 m
4600.316 – .332	Tube JRG Sanipex MT	d16–d32	noir, en barres, 3 m
4602.016 – .026	Tube JRG Sanipex MT	d16–d26	blanc, en rouleau, avec tube protecteur
4604.016 – .032	Tube JRG Sanipex MT	d16–d32	blanc, en rouleau
4606.016 – .226	Tube JRG Sanipex MT	d16–d26	blanc, en rouleau, isolé
5706.016 – .025	Tube JRG Sanipex	d16–d25	blanc, en rouleau, avec tube protecteur
5707.016 – .025	Tube JRG Sanipex	d16–d25	blanc, en rouleau
5708.016 – .025	Tube JRG Sanipex	d16–d25	blanc, en barres, 6 m
5710.016 – .220	Tube JRG Sanipex	d16/d20	blanc, en rouleau, isolé
5716.016 – .020	Tube JRG Sanipex	d16/d20	bleu, en rouleau, avec tube protecteur
5717.016 – .020	Tube JRG Sanipex	d16/d20	bleu, en rouleau

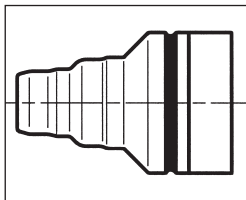

Choisir les mandrins d'élargissement

- Pour les tubes JRG Sanipex MT d16 x 2,25 mandrin avec une rainure, noir
- Pour les tubes JRG Sanipex MT d20 x 2,5 mandrin avec une rainure, bleu
- Pour les tubes JRG Sanipex MT d26 x 3,0 mandrin avec une rainure, rouge
- Pour les tubes JRG Sanipex MT d32 x 3,0 mandrin avec une rainure, vert

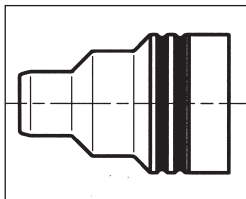

- Pour les tubes JRG Sanipex PE-Xa et PE-Xc d16 x 2,2
mandrin avec deux rainures, noir
- Pour les tubes JRG Sanipex PE-Xa et PE-Xc d20 x 2,8
mandrin avec deux rainures, bleu

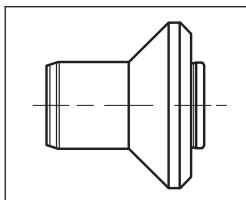

- Pour les tubes JRG Sanipex PE-Xa et PE-Xc d25 x 3,5
mandrin sans rainures, rouge

Changement du mandrin d'élargissement

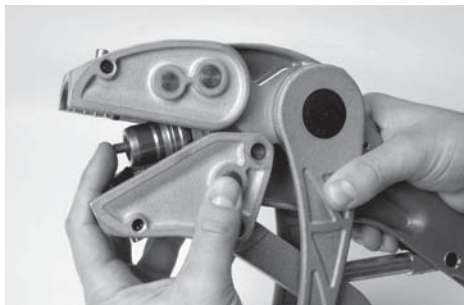

Fermer un peu le levier de travail (3) et le maintenir dans cette position. Ceci décharge le mécanisme de maintien. En pressant la tige de guidage (1), le mandrin d'élargissement (5) est libéré. Maintenir le levier de travail dans la même position.

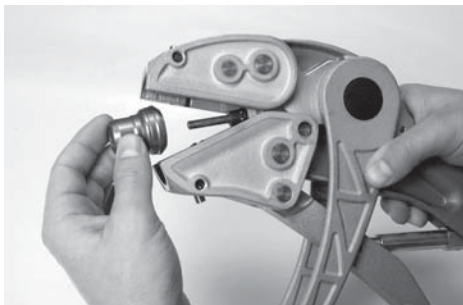

Glisser le mandrin d'élargissement (5) désiré sur la tige de guidage (1), presser sur celle-ci et faire glisser le mandrin d'élargissement (5) jusqu'en butée. Le changement du mandrin d'élargissement (5) est terminé lorsque l'on relâche la tige de guidage (1).

Changement des mâchoires

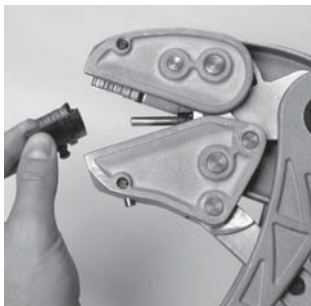
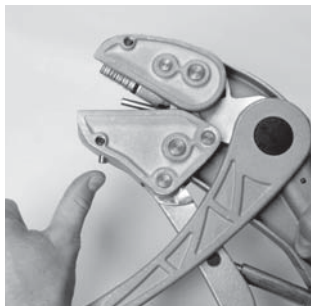

En pressant sur la tige de guidage les mâchoires (2) inférieure ou supérieure seront libérées de leurs glissières. Celles-ci peuvent être ainsi remplacées par les mâchoires désirées jusqu'à qu'elles soit complètement enclenchées.

Montage



Couper à la longueur désirée le tube JRG Sanipex MT (seulement d16 et d20, no JRG: 4837) ou à l'aide de la pince combinée avec coupe-tube (no JRG: 4836).

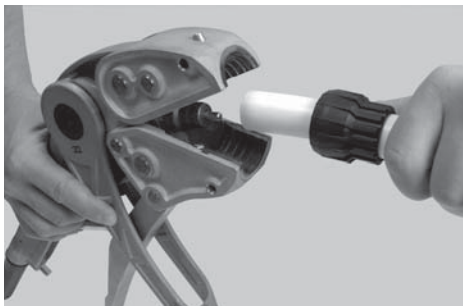

Après avoir glissé l'écrou de raccordement, introduire le tube JRG Sanipex MT jusqu'au seuil de résistance sur le mandrin dans la pince d'élargissement et fermer le levier de fixation (4).



Note

Mandrin d'élargissement correct

Veuillez à utiliser un mandrin d'élargissement (5) et des mâchoires (2) adaptés au tube.

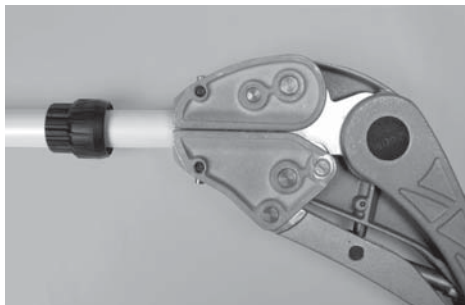

Mener le processus d'élargissement en refermant le levier de travail (3).



Note
Élargissement de tubes
JRG Sanipex en PE-X

Le raccord doit être effectué immédiatement lorsque l'on a élargi des tubes JRG Sanipex PE-X flexibles.

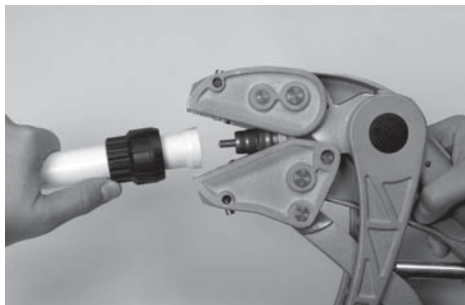

Ouvrir le levier de travail (3). L'extrémité du tube, maintenant dotée d'un rebord, est libérée.



Note

Le levier doit être manipulé avec précaution si l'on devait ouvrir l'organe de serrage sans avoir effectué un élargissement du tube. En effet la vitesse d'ouverture est telle qu'elle pourrait conduire à un démontage incontrôlé des mâchoires.

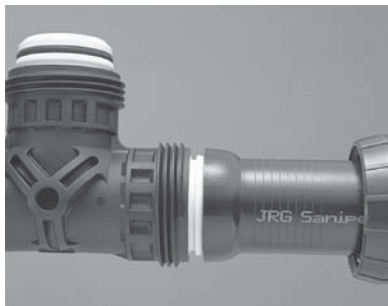
Assemblage correct

Contrôle du processus d'élargissement.
Le joint O-ring du raccord doit être entièrement recouvert par le rebord du tube.

**Avertissement**
Rebord mal formé

Les rebords de tube mal formés
ne doivent pas être retravaillés!

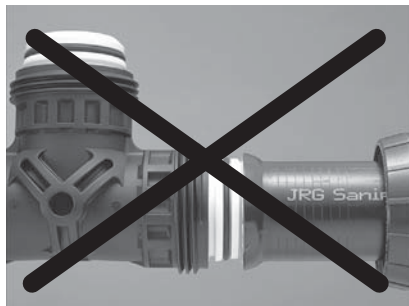
Assemblage faux



Enfiler le tube JRG Sanipex MT doté de son rebord sur le raccord JRG Sanipex MT. Serrer à la main l'écrou de raccord.



Serrer ensuite l'écrou de raccord à l'aide de la clé dynamométrique à cliquet (no JRG: 4832). Pour maintenir, utiliser une douille d'ajustage (no JRG: 5777) ou la contre-clé (no JRG: 4834).

**Avertissement****Dérangements dans le fonctionnement de la clé dynamométrique à cliquet**

En cas de dérangement ou si la clé est endommagée, nous recommandons de procéder au remplacement de la clé dynamométrique à cliquet JRG Sanipex MT.

**Avertissement****Réparations de la clé dynamométrique à cliquet**

Aucune réparation ne doit être pratiquée sur la clé dynamométrique à cliquet JRG Sanipex MT.

**Note****Clé dynamométrique à cliquet**

Les clés dynamométrique à cliquet JRG Sanipex MT servent exclusivement au serrage des raccords à rebords JRG Sanipex MT. Les couples correspondants sont réglés d'usine. Aucun entretien n'est nécessaire en cas d'utilisation conforme.

Remplacement de la molette

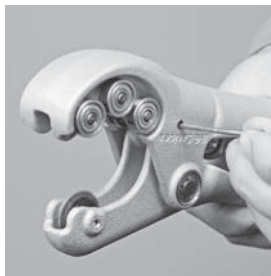

Ouvrir complètement le coupe-tubes en actionnant le levier. Faire glisser la cheville d'arrêt (p.ex. aiguille de $\varnothing 3$ mm) au travers du perçement. De ce fait, le coupe-tubes restera en position ouverte en toute sécurité.



Danger **Brusque détente de la molette**

Les membres peuvent être blessés!
Il convient de remplacer la molette uniquement lorsque le levier est arrêté.



Desserrer la vis à tête cylindrique à l'aide d'un tourne-vis. Remplacer la molette. Serrer la vis et retirer la cheville d'arrêt.



Note **Axe de la molette**

Depuis janvier 2002, seuls des axes étagés sont utilisés. Ces axes remplacent la cheville cylindrique avec douille. Lors d'un éventuel remplacement de la molette, il convient, pour autant qu'il n'existe pas encore, de poser un axe étagé, livrable sous le no. Art.16 003 15.

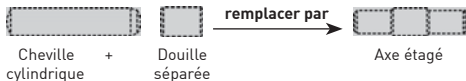

Pliage à l'aide du gablon de cintrage à main



Tracer l'arc du tube.
Introduire le tube dans le
gablon de cintrage à main.
Observer le début du pliage.



Pliage du tube en arc.
Pendant le pliage, le tube doit
être maintenu le mieux possi-
ble le long du gabarit de pliage.



Retirer les arcs de tube
terminés hors du gablon de
cintrage à main.

Angle (cm)

d	90°	60°	45°	30°
16	5.6	3.2	2.3	1.5
20	7.0	4.0	2.9	1.9
26	9.1	5.3	3.8	2.4

**Note****Contrôle des outils**

Un outil propre et en parfait état de fonctionnement est la condition fondamentale pour l'obtention d'un assemblage durablement étanche.

C'est la raison pour laquelle, nous recommandons de soigner les outils et de régulièrement faire contrôler leur état de fonctionnement une fois par année.

**Attention****Réparation des outils**

Il est formellement interdit de procéder à des réparations et des modifications aux réglages d'usine des outils JRG Sanipex MT. En cas de dérogation, nous déclinons toute garantie et responsabilité.

Pour les outils défectueux, veuillez contacter notre conseiller de vente technique.

Istruzioni d'uso e montaggio

JRG Sanipex MT

4802.000

d16/d20/d25/d26/d32

Valigetta di montaggio | 29 – 43



+GF+

JRG

Istruzioni d'uso e di montaggio

Vi preghiamo di leggere attentamente le presenti istruzioni d'uso e di montaggio prima di usare l'attrezzo.

La procedura di montaggio è anche valida per i tubi JRG Sanipex PE-X.

I simboli rappresentati significano:



Avvertimento

Questo segnale richiama l'attenzione su un'informazione che se trascurata, può essere causa di notevoli danni a cose. È necessario attenersi rigorosamente alle norme di sicurezza.



Istruzione

Questo segnale richiama l'attenzione su un'informazione contenente importanti indicazioni concernenti l'uso. L'inosservanza di queste indicazioni può causare guasti.

Le istruzioni d'uso e di montaggio costituiscono una parte integrante della valigia di montaggio **JRG Sanipex MT**. Esse vanno pertanto conservate nella valigia.

Costruzione dell'espansore manuale JRG Sanipex MT

- 1 Spina di guida per mandrino allargatubi
- 2 Morsetti di chiusura
- 3 Leva di lavoro
- 4 Leva di chiusura

Valigetta di montaggio d16+d20+d25+d26+d32, JRG no. 4802.000

La valigia 4828.005 contiene:

4805.000	Espansore manuale
4832.016	Chiave dinamometrica a raganella d16
4832.020	Chiave dinamometrica a raganella d20
4832.026	Chiave dinamometrica a raganella d26
4832.032	Chiave dinamometrica a raganella d32
4834.016	Controchiave d16
4834.020	Controchiave d20
4834.026	Controchiave d26
4834.032	Controchiave d32
4806.016	Curvatubi manuale d16
4806.020	Curvatubi manuale d20
4806.026	Curvatubi manuale d26 (optional)
4837.000	Forbice universale d16/d20
4836.000	Tagliatubo d16-d40
4838.000	Raschietto di marcatura
4805.016	Morsetti di chiusura d16 per tubo MT e PE-X
4805.020	Morsetti di chiusura d20 per tubo MT e PE-X
4805.026	Morsetti di chiusura d26 per tubo MT
4805.032	Morsetti di chiusura d32 per tubo MT
4805.125	Morsetti di chiusura d25 per tubo PE-X
4804.116	Mandrino allargatubi d16 per tubo MT
4804.120	Mandrino allargatubi d20 per tubo MT
4804.126	Mandrino allargatubi d26 per tubo MT
4804.132	Mandrino allargatubi d32 per tubo MT
4804.216	Mandrino allargatubi d16 per tubo PE-X
4804.220	Mandrino allargatubi d20 per tubo PE-X
4804.225	Mandrino allargatubi d25 per tubo PE-X
35 09 458 67	Istruzioni d'uso e di montaggio

Introduzione

Gli attrezzi di montaggio JRG Sanipex MT sono destinati esclusivamente al montaggio dei sistemi d'installazione JRG Sanipex MT e, se usati appropriatamente, non richiedono ulteriore manutenzione.

Gli attrezzi contenuti possono essere utilizzati soltanto per i componenti del sistema JRG

Sanipex MT e non possono essere utilizzati per fini diversi.

Sugli attrezzi JRG Sanipex MT non possono essere eseguite riparazioni né modifiche di qualsiasi natura.

I seguenti tubi possono essere allargati con l'espansore manuale (JRG no. 4800.000) JRG Sanipex MT:

4600.016 – .032	Tubo JRG Sanipex MT	d16–d32	nero, in barre, 5 m
4600.316 – .332	Tubo JRG Sanipex MT	d16–d32	nero, in barre, 3 m
4602.016 – .026	Tubo JRG Sanipex MT	d16–d26	bianco, in bobine, con guaina
4604.016 – .032	Tubo JRG Sanipex MT	d16–d32	bianco, in bobine
4606.016 – .226	Tubo JRG Sanipex MT	d16–d26	bianco, in bobine, isolato
5706.016 – .025	Tubo JRG Sanipex	d16–d25	bianco, in bobine, con guaina
5707.016 – .025	Tubo JRG Sanipex	d16–d25	bianco, in bobine
5708.016 – .025	Tubo JRG Sanipex	d16–d25	bianco, in barre, 6 m
5710.016 – .220	Tubo JRG Sanipex	d16/d20	bianco, in bobine, isolato
5716.016 – .020	Tubo JRG Sanipex	d16/d20	blu, in bobine, con guaina
5717.016 – .020	Tubo JRG Sanipex	d16/d20	blu, in bobine

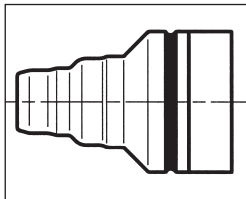

Scelta dei mandrini espansori

- Per tubi JRG Sanipex MT d16 x 2,25 Mandrino espansore, con una scanalatura, nero
- Per tubi JRG Sanipex MT d20 x 2,5 Mandrino espansore, con una scanalatura, blu
- Per tubi JRG Sanipex MT d26 x 3,0 Mandrino espansore, con una scanalatura, rosso
- Per tubi JRG Sanipex MT d32 x 3,0 Mandrino espansore, con una scanalatura, verde

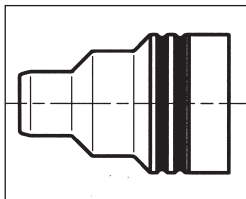

- Per tubi JRG Sanipex PE-Xa et PE-Xc d16 x 2,2
Mandrino espansore, con due scanalature, nero
- Per tubi JRG Sanipex PE-Xa et PE-Xc d20 x 2,8
Mandrino espansore, con due scanalature, blu

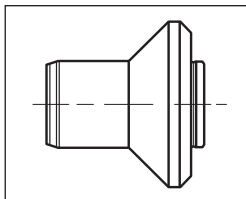

- Per tubi JRG Sanipex PE-Xa et PE-Xc d25 x 3,5
Mandrino espansore senza scanalature, rosso

Cambio del mandrino allargatubi

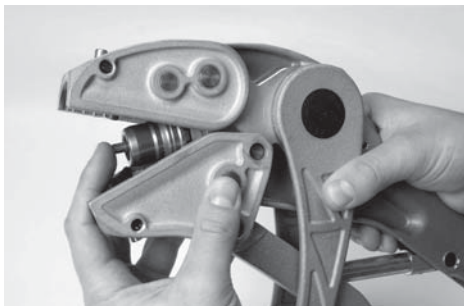

Chiudere un poco la leva di lavoro (3) e tenerla in questa posizione. A questo modo si rilascia il meccanismo di presa. Spingendo la spina di guida (1) il mandrino allargatubi (5) viene liberato. Tenere la leva di lavoro invariata.

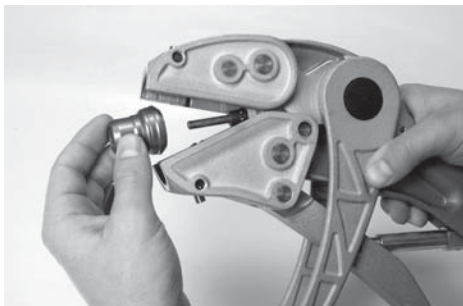

Infilare il mandrino allargatubi (5) desiderato sulla spina di guida (1). Spingere la spina di guida (1) e mandare in battuta il mandrino allargatubi (5).

Il cambio del mandrino allargatubi (5) ha avuto luogo quando si rilascia la spina di guida (1).

Cambio dei morsetti di chiusura

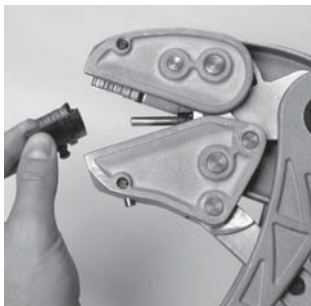
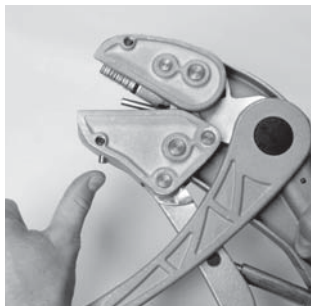

Premendo il perno superiore o inferiore, i rispettivi morsetti di chiusura (2) vengono rilasciati. Sfilare i morsetti dalla guida ed inserire i morsetti di chiusura desiderati fino a completare lo scatto.

Procedimento di montaggio



Tagliare il tubo JRG Sanipex MT (solamente d16 e d20, JRG no. 4837) o alla lunghezza desiderata usando la forbice universale con tagliatubo (JRG no. 4836).

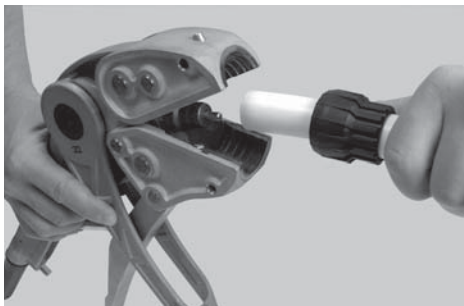

Attenzione: ricordarsi di inserire il dado del raccordo sul tubo. Appoggiare il mandrino espansore della pinza al tubo fino al fermo, serrare la leva di chiusura (4). Azionare fino in fondo la leva di lavoro.



Istruzione

Giusto mandrino allargatubi

Assicurarsi che il mandrino allargatubi (5) ed i morsetti di chiusura (2) abbiano le dimensioni giuste per il tubo impiegato.

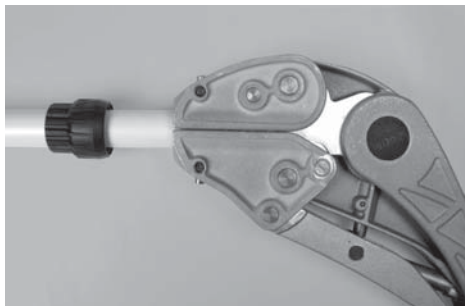

Procedere per l'allargamento del tubo chiudendo la leva di lavoro (3).



Istruzione
Allargamento di tubi
JRG Sanipex in PE-X

In caso di lavori d'allargamento di tubi flessibili JRG Sanipex PE-X occorre immediatamente completare tutto il raccordo.

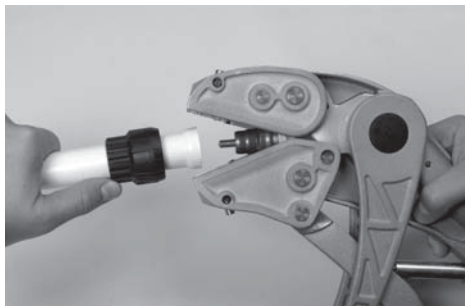

Aperto la leva di lavoro (3) si libera l'estremità allargata del tubo.



Istruzione

Se l'unità di bloccaggio deve essere aperta senza aver effettuato una espansione del tubo, la leva deve essere aperta con cura, altrimenti la rapidità di apertura potrebbe portare a una caduta incontrollata delle ganasce.

Raccordo a morsetto corretto

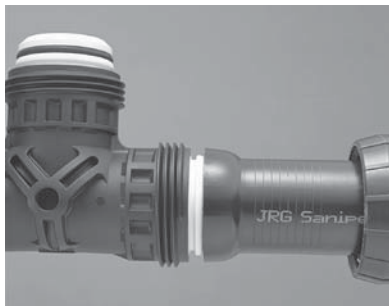

Raccordo a morsetto errato

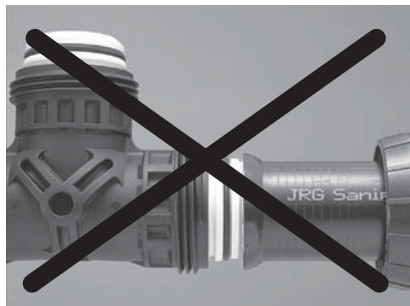

Controllo del procedimento d'allargamento
L'O-ring del raccordo deve essere completamente coperto dalla bordatura.



Avvertimento

Bordatura di tubo non corretta

Le bordature effettuate non correttamente, non possono essere rifatte!



Innestare il tubo JRG Sanipex MT allargato nel raccordo JRG Sanipex MT. Stringere forte a mano il dado di chiusura.



Stringere il dado di chiusura con la chiave dinamometrica a raganella cricco (JRG no. 4832). Usare la guida del tubo (JRG no. 5777) o la controchiave (JRG no. 4834) per contrastare lo sforzo di torsione generato dalla chiusura.

**Avvertimento****Disturbi di funzionamento della chiave dinamometrica a raganella**

In caso di difetti di funzionamento o in caso di danni subiti, consigliamo di sostituire le chiavi dinamometriche a raganella JRG Sanipex mediante cambio.

**Avvertimento****Riparazioni delle chiavi dinamometriche a raganella**

Non è consentito effettuare riparazioni alle chiavi dinamometriche a raganella JRG Sanipex MT.

**Istruzione****Chiave dinamometrica a raganella**

Le chiavi dinamometriche a raganella JRG Sanipex MT servono unicamente al serraggio di raccordi a morsetto da bordare JRG Sanipex MT. I rispettivi valori di coppia sono stati regolati in fabbrica e, se usati per lo scopo predestinato, non richiedono ulteriori aggiustamenti.

Sostituzione della rotella di taglio

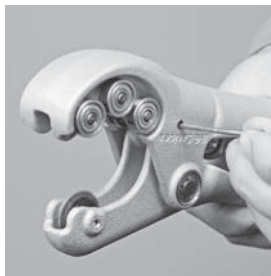

Aprire completamente il tagliatubi azionando la leva. Spingere nel foro la spina di fermo (ad es. chiodo da $\varnothing 3$ mm). Così, il tagliatubi rimane aperto in modo sicuro.



Pericolo
Rotella di taglio con ritorno a molla
 Possibilità di lesione degli arti!
 La rotella di taglio può essere sostituita solo con la leva bloccata.



Allentare la vite a testa cilindrica con un cacciavite. Sostituire la rotella di taglio. Serrare la vite e togliere la spina di fermo.



Istruzione

Rotella di taglio – alberino

Dal gennaio 2002, vengono impiegati solo alberini sfalsati. Questi alberini sostituiscono la spina cilindrica con la boccola. In caso di eventuale sostituzione della rotella di taglio, deve essere impiegato un alberino sfalsato se non ancora esistente. Questo è disponibile con il numero di articolo 16 003 15.



Piegatura con curvatubi manuale



Marcare la curva. Infilare il tubo nella dima. Prestare attenzione all'inizio della curva.



Piegatura del tubo. Durante la piegatura il tubo deve possibilmente seguire da vicino la curvatura della dima.



Estrarre la curva finita dalla dima.

Misura della curva (cm)

d	90°	60°	45°	30°
16	5.6	3.2	2.3	1.5
20	7.0	4.0	2.9	1.9
26	9.1	5.3	3.8	2.4



Istruzione
Controllo degli attrezzi

Un attrezzo pulito e ben funzionante è la premessa per un accoppiamento ermetico durevole.

Pertanto, vi raccomandiamo di curare gli attrezzi e di farli controllare regolarmente una volta all'anno per la loro funzionalità.

Il nostro consulente tecnico di vendita è a vostra disposizione.



Avvertimento
Riparazioni degli attrezzi

Non si devono effettuare riparazioni o modifiche delle regolazioni di fabbrica sugli attrezzi JRG Sanipex MT. In caso di violazione, decade qualsiasi garanzia e responsabilità.

Contattate il nostro consulente tecnico di vendita in caso di attrezzi difettosi.

Operating- and installation
instructions

JRG Sanipex MT

4802.000

d16/d20/d25/d26/d32

Fitter's toolkit

E 45 – 59



+GF+

JRG

Operating- and installation instructions

Please read carefully the operating- and installation instructions presented here before using any of the tools.

The installation procedure is also applicable in analogy for JRG Sanipex PE-X pipes.

The symbols utilized signify:



Warning

This symbol draws attention to information, the non-observance of which may lead to extensive material damage. The safety indications have to be observed.



Remark

This symbol draws attention to information, which contains important indications with respect to the utilization. Non-observance may lead to malfunctions.

The operating- and installation instructions are a component part of the **JRG Sanipex MT** installation tools. They have to be stored in the tool box available for consultation.

Construction of the JRG Sanipex MT expansion pliers

- 1 Guide pin for expansion mandrel
- 2 Clamping jaws
- 3 Operating lever
- 4 Clamping lever

Filter's toolkit d16+d20+d25+d26+d32, JRG no. 4802.000

Contained in the filter's toolkit 4828.005 are the following:

4805.000	Expansion pliers
4832.016	Ratchet torque wrench d16
4832.020	Ratchet torque wrench d20
4832.026	Ratchet torque wrench d26
4832.032	Ratchet torque wrench d32
4834.016	Countering spanner d16
4834.020	Countering spanner d20
4834.026	Countering spanner d26
4834.032	Countering spanner d32
4806.016	Hand bending template d16
4806.020	Hand bending template d20
4806.026	Hand bending template d26 (optional)
4837.000	Multi-purpose cutter d16/d20
4836.000	Pipe cutter d16-d40
4838.000	Marking pen
4805.016	Clamping jaws d16 for pipe MT and PE-X
4805.020	Clamping jaws d20 for pipe MT and PE-X
4805.026	Clamping jaws d26 for pipe MT
4805.032	Clamping jaws d32 for pipe MT
4805.125	Clamping jaws d25 for pipe PE-X
4804.116	Expansion mandrel d16 for pipe MT
4804.120	Expansion mandrel d20 for pipe MT
4804.126	Expansion mandrel d26 for pipe MT
4804.132	Expansion mandrel d32 for pipe MT
4804.216	Expansion mandrel d16 for pipe PE-X
4804.220	Expansion mandrel d20 for pipe PE-X
4804.225	Expansion mandrel d25 for pipe PE-X
35 09 458 67	Operating- and installation instructions

Introduction

The JRG Sanipex MT installation tools are exclusively foreseen for utilization with the JRG Sanipex MT installation system, and providing they are used correctly and in accordance with their purpose they do not require any further maintenance or servicing.

Only JRG Sanipex MT systems components must be processed with these tools. The tools must not be utilized for other purposes.

No repairs or modifications of any kind whatsoever must be carried out on JRG Sanipex MT tools.

The following pipes can be expand with the JRG Sanipex MT expanding pliers [JRG no. 4800.000]:

4600.016 – .032	JRG Sanipex MT pipe	d16–d32	black, in bars, 5 m
4600.316 – .332	JRG Sanipex MT pipe	d16–d32	black, in bars, 3 m
4602.016 – .026	JRG Sanipex MT pipe	d16–d26	white, in coils with protective conduit
4604.016 – .032	JRG Sanipex MT pipe	d16–d32	white, in coils
4606.016 – .226	JRG Sanipex MT pipe	d16–d26	white, in coils, isolated
5706.016 – .025	JRG Sanipex pipe	d16–d25	white, in coils with protective conduit
5707.016 – .025	JRG Sanipex pipe	d16–d25	white, in coils
5708.016 – .025	JRG Sanipex pipe	d16–d25	white, in bars, 6 m
5710.016 – .220	JRG Sanipex pipe	d16/d20	white, in coils, isolated
5716.016 – .020	JRG Sanipex pipe	d16/d20	blue, in coils with protective conduit
5717.016 – .020	JRG Sanipex pipe	d16/d20	blue, in coils

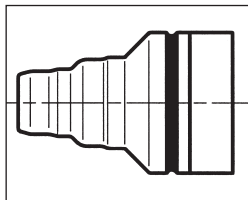

Selection of the expansion mandrels

- For JRG Sanipex MT pipes d16 x 2,25 Expansion mandrel with one groove, black
 For JRG Sanipex MT pipes d20 x 2,5 Expansion mandrel with one groove, blue
 For JRG Sanipex MT pipes d26 x 3,0 Expansion mandrel with one groove, red
 For JRG Sanipex MT pipes d32 x 3,0 Expansion mandrel with one groove, green

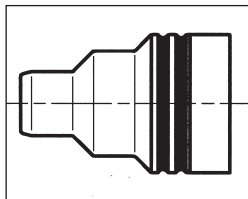

- For JRG Sanipex PE-Xa and PE-Xc pipes d16 x 2,2
 Expansion mandrel with two grooves, black
 For JRG Sanipex PE-Xa and PE-Xc pipes d20 x 2,8
 Expansion mandrel with two grooves, blue

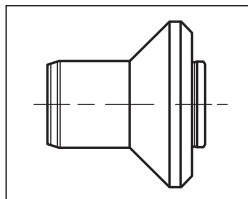

- For JRG Sanipex PE-Xa and PE-Xc pipes d25 x 3,5
 Expansion mandrel without grooves, red

Changing the expansion mandrels

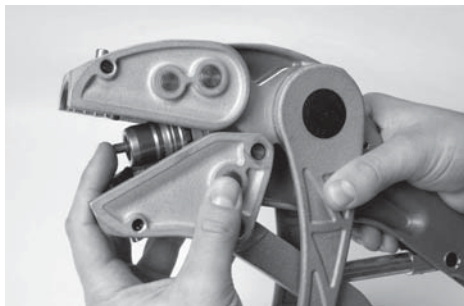

Close the operating lever (3) slightly and hold it in this position. As a result of this, the holding mechanism is relieved. The expansion mandrel (5) is released by pressing the guide pin (1). Keep holding the operating lever the same way.

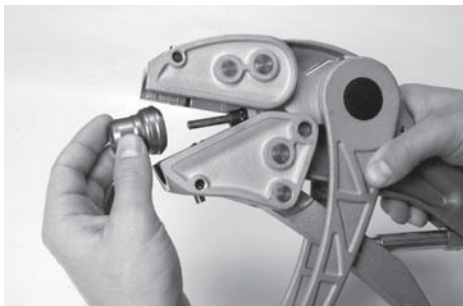

Slide the required expansion mandrel (5) over the guide pin (1). Press the guide pin (1) and slide the expansion mandrel (5) right up to the stop. The changing of the expansion mandrel (5) has been completed, as soon as the guide pin (1) is released.

Changing the clamping jaws

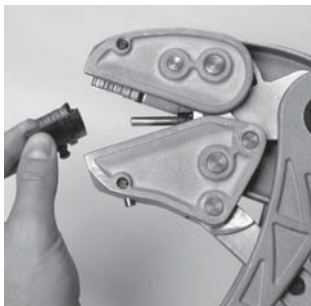
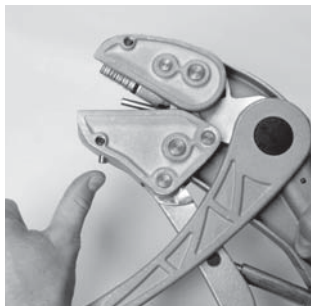

By pressing the upper or lower release pin, the respective clamping jaws (2) are released. Remove the clamping jaws via guidance and insert the desired clamping jaws until the snap.

Installation procedure



Cut the JRG Sanipex MT pipe (only d16 and d20, JRG no. 4837) to the required length or with the multi-purpose-cutter and pipe cutter (JRG no. 4836).

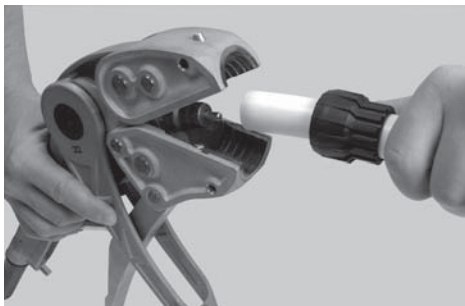

After sliding over the plastic nut, the JRG Sanipex MT pipe has to be pushed over the mandrel until the mark, after that close the clamping lever (4).



Remark

Correct expansion mandrel

Pay attention, that the expansion mandrel (5) corresponding to the respective pipe as well as the clamping jaws (2) corresponding to the respective dimension are in place.

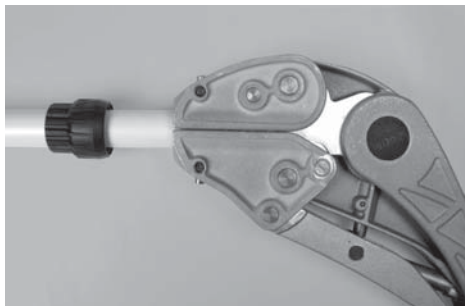

Carry out the expansion process by closing the operating lever (3).



Remark
Expansion of JRG Sanipex pipes made of PE-X
 After the flaring of flexible JRG Sanipex pipes PE-X, the connection has to be completed immediately.

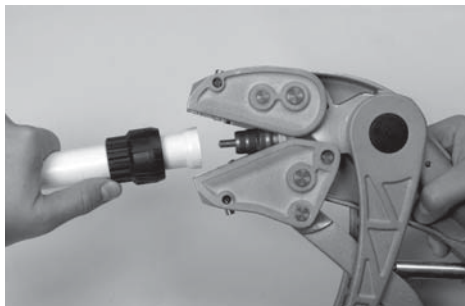

Open the operating lever (3) and the flared pipe end is released.



Remark
 If the clamping unit shall be released without expanding the pipe, the lever must be opened carefully, otherwise the high opening speed could bring an uncontrolled fall out of the clamping jaws.

Clamping joint, correct

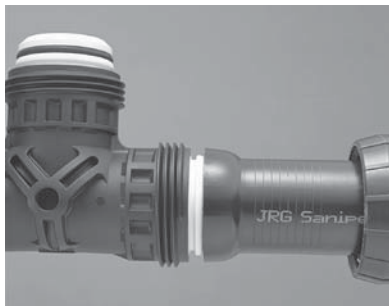

Clamping joint, incorrect

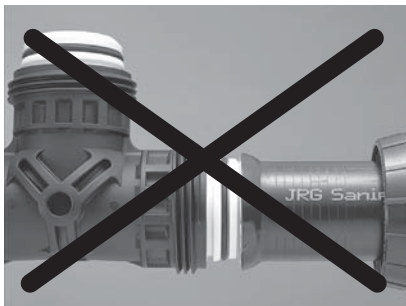

Checking the flaring process.
The O-ring at the fitting has to be completely covered by the pipe flare.



Warning

Not correctly formed pipe flare

Must not be expanded once again!

E



Insert the flared JRG Sanipex MT pipe onto the JRG Sanipex MT fitting. Tighten the union nut by hand only.



Finally tighten the union nut with the ratchet torque wrench (JRG no. 4832). For counter-bracing, use the alignment gauge (JRG no. 5777) or the counterbracing spanner (JRG no. 4834).

**Warning****Operational malfunctions of the ratchet torque wrench**

In the case of any operational malfunctions or in case of any damage, we recommend, that the JRG Sanipex MT ratchet torque wrench should be replaced by exchanging it with a new or works refurbished one.

**Warning****Repairs to the ratchet torque wrenches**

Absolutely no repairs must be carried out on JRG Sanipex MT ratchet torque wrenches.

**Remark****Ratchet torque wrenches**

The JRG Sanipex MT ratchet torque wrenches are destined exclusively for the tightening of JRG Sanipex MT flared clamped joints. The corresponding torques are adjusted fixed by the manufacturing works and in case of correct and proper usage the torque wrenches do not require any further servicing or maintenance.

Replacement of pipe cutter wheel

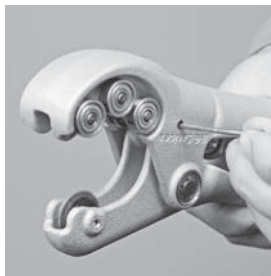

Open the pipe cutter by operating the lever.
Push lock bolt (e.g. nail of $\varnothing 3$ mm) through the drilled hole.
Thus the pipe cutter remains secured open.



Danger **Resile of pipe cutter wheel**

Fingers can be hurt!
The pipe cutter wheel have to be changed only with locked lever.



Detach the screw with a screwdriver.
Replace the pipe cutter wheel.
Tighten the screw and remove the lock bolt.



Notice **Cutting wheel – axis**

Since January 2002 only hubbed axis are used. These axis replaces the cylindrical bolt with socket. A hubbed axis have to be used, as far as not yet available, changing the cutter wheel. The hubbed axis has the art. no. 16 003 15.



Bending with the manual bending template



Mark the pipe bend. Insert the pipe into the manual bending template. Pay attention to the start of the bend.



Bending the pipe bend. During bending, the pipe has to be guided as closely along the bending gauge as possible.



Remove the completed pipe bend from the manual bending template.

Bending angle (cm)

d	90°	60°	45°	30°
16	5.6	3.2	2.3	1.5
20	7.0	4.0	2.9	1.9
26	9.1	5.3	3.8	2.4



Note
Tools inspection

A tool that is well working and clean is the basic condition for a durably tight connection.

We recommend therefore to maintain the tools regularly and let them check once a year on efficiency.

Our technical advisers are at your disposal for this.



Warning
Repairs on tools

On JRG Sanipex MT-tools no repairs or changes of factory settings may be made. Through contravention any guarantee and adhesion are void.

Contact our technical advisers if there are defective tools.

Georg Fischer JRG AG

Hauptstrasse 130

CH-4450 Sissach

Phone +41 (0)61 975 22 22, Fax +41 (0)61 975 22 00

www.jrg.ch, info.jrg.ps@georgfischer.com

Georg Fischer JRG SA

Via Boscioro 20

CH-6962 Viganello/Lugano

Phone +41 (0)91 972 26 26, Fax +41 (0)91 972 26 27

www.jrg.ch, ti.jrg.ps@georgfischer.com

Georg Fischer GmbH

Nördliche Grünauerstrasse 65

D-86633 Neuburg/Donau

Phone +49 (0)8431 5817-0, Fax +49 (0)8431 5817-20

www.jrg.de, info.jrg.ps@georgfischer.com