

**SCHONSTEDT**® 

## Instruction Manual



## Magnetic Locator



**Schonstedt Instrument Company**

100 Edmond Road, Kearneysville, WV 25430

P: (304) 725-1050

| [www.schonstedt.com](http://www.schonstedt.com)

| [schonstedt.inf@spx.com](mailto:schonstedt.inf@spx.com)

**SPX** 

## **Important Notice**

Schonstedt believes the statements contained herein to be accurate and reliable; however, their accuracy, reliability, or completeness is not guaranteed.

Schonstedt's only obligation shall be to repair or replace any instrument proven to be defective within seven years of purchase. Schonstedt shall not be responsible for any injury to persons or property, direct or consequential, arising from the use of any instrument.

October 2018

## Table of Contents

<b>Chapter 1: Introduction</b> .....	<b>4</b>
<b>Chapter 2: Operating Instructions</b> .....	<b>6</b>
Operating Controls .....	7
Signal Strength .....	8
Battery Level .....	8
Replacing the Battery .....	8
<b>Chapter 3: Operating Recommendations and Application Notes</b> .....	<b>9</b>
Search Procedure .....	10
Basic Signal Patterns .....	10
Strongly Magnetized Markers .....	12
Correct Stake Orientation .....	12
Locating Manholes, Septic Tanks and Well Casings.....	13
Locating and Tracing Barbed Wire .....	14
Searching Areas along a Chain Link Fence .....	14
Locating Valve Boxes .....	15
Locating Cast-Iron Pipes .....	16
Locating Steel Drums .....	17
Additional Notes .....	17
<b>Chapter 4: Specifications and Regulatory Compliance</b> .....	<b>18</b>
Specifications .....	19
Regulatory Compliance and Declaration of Conformity.....	20
<b>Chapter 5: Technical Support/Service Information</b> .....	<b>21</b>
<b>Chapter 6: Warranty</b> .....	<b>23</b>

# 1

## INTRODUCTION



## Introduction

SPOT, a magnetic locator, detects the magnetic field of ferromagnetic objects. It responds to the difference in the magnetic field between two sensors that are spaced approximately 20 inches apart. This difference is referred to as the “signal strength” throughout this manual and is represented in the instrument by an audio tone that changes its frequency to help you pinpoint a target and determine its orientation.

Figure 1 illustrates SPOT detecting an iron marker that is used for property line identification. As shown, the magnetic field of the iron marker is stronger at sensor A than it is at sensor B. This creates a signal strength that is larger than zero (which would occur when the field strength is the same at both sensors).

The audio response of SPOT is designed so that the frequency of the audio tone increases as the detected signal strength increases. As a result, the frequency of the audio output is higher than the idling frequency (~ 30 Hz), which exists when the signal strength is approximately zero.

Following in the steps of Schonstedt’s iconic magnetic locator, the GA-52Cx, SPOT retains the “yellow stick” look, the sturdiness of the Aluminum tube and the exact same performance (including the same 5 gain settings). However, SPOT adds modern ergonomics and functionality, plus improved environmental performance.

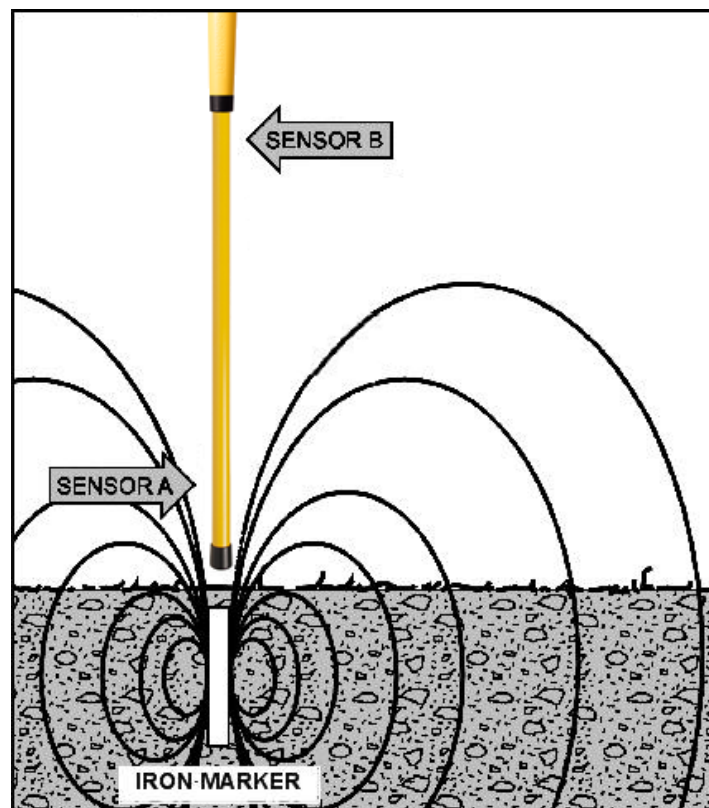

Figure 1: Detecting the Magnetic Field of an Iron Marker

# 2

## OPERATING INSTRUCTIONS



## Operating Controls

The controls on SPOT are designed to be intuitive and require minimal training for effective use. The locator can easily be operated with one hand.

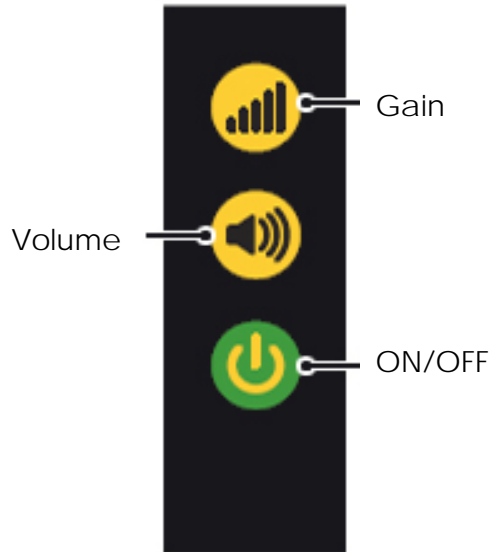

Figure 2: SPOT® Membrane Switch



**ON/OFF:** Push this button to turn the unit on or off. Upon turn **ON**, the unit emits 1 short beep indicating that the gain setting is #1 (1=Extra Low, the default setting on power up).



**Volume:** Upon turn **ON**, the volume defaults to HIGH. Pushing this button changes the volume to MEDIUM. Additional pushes of this button toggle the volume between HIGH and MEDIUM.



**Gain:** The sensitivity of the unit can be increased (to detect smaller objects at greater depths) or decreased (to detect larger objects at shallower depths) by adjusting the gain. The sensitivity mirrors that of the GA-52Cx: 1=Extra Low, 2=Low, 3=Medium, 4=High and 5=Extra High. Each time the gain is changed, the unit emits a number of short beeps equal to the gain setting (i.e. one beep for gain #1, two beeps for gain #2, and so on).

## Signal Strength

The signal strength -- defined as the difference, or delta ( $\Delta$ ), between the magnetic field detected at the top and bottom sensors -- is indicated by the frequency of the audio signal. A higher audio frequency tone indicates a stronger signal; a lower audio frequency tone indicates a weaker signal.

## Battery Level

When the battery level gets to be too low (6.8 V), the unit starts to beep for approximately  $\frac{1}{2}$  second, every 13 seconds, to remind the user that the battery needs to be replaced. When you hear this tone, replace the battery as soon as possible. Battery life varies with usage and ambient temperature. Cold temperatures reduce battery life. When the battery level reaches 6.0 V, the unit turns off to protect the electronic circuits inside.

## Replacing the Battery

SPOT is powered by one 9-volt disposable battery. The battery compartment is located near the top of the locator, as shown in Figure 3. To remove the battery, simply unscrew the two flat head screws holding the battery door. The screws are captive and will not come off the battery door. Once you have removed the battery door, gently pull the battery from its compartment and unplug the connector.

Connect a new battery, place it back in the compartment, and replace and screw in the battery door. As a safety measure, the unit will not turn on if the battery connector is not inserted correctly. You should never have to force the battery door closed. If the battery does not sit easily and flat in place, check the battery and the connector for proper seating in the battery compartment.



Figure 3: Replacing the Battery



# 3

## OPERATING RECOMMENDATIONS AND APPLICATION NOTES



## Search Procedure

Turn the instrument ON. The gain defaults to Extra Low (#1), as indicated by one beep emitted upon turn ON. Depending on the size and orientation of your target, you may have to increase the gain. A typical operating range for the gain is #2 or #3. Grasp the locator, as illustrated in Figure 4.

Because the upper sensor is near the top of the locator, wristwatches may produce unwanted changes in the audio signal and should be removed. Keep the locator away from your shoes and any keys that may be in your pockets; these items may contain magnetic material.

To obtain maximum area coverage, sweep the locator from side to side. When the locator comes within range of an iron object, the signal strength will peak, causing the frequency of the audio signal to peak.

**NOTE:** The frequency of the audio signal will depend on the signal strength, which is affected by the type of iron object detected, its orientation and the gain setting.



Figure 4: Searching with SPOT

## Basic Signal Patterns

When SPOT is positioned directly over a vertical target, the signal strength will peak (audio signal will be at highest frequency, depending on the gain setting). The audio signal also peaks over each end of a horizontal target, as shown in Figure 5.

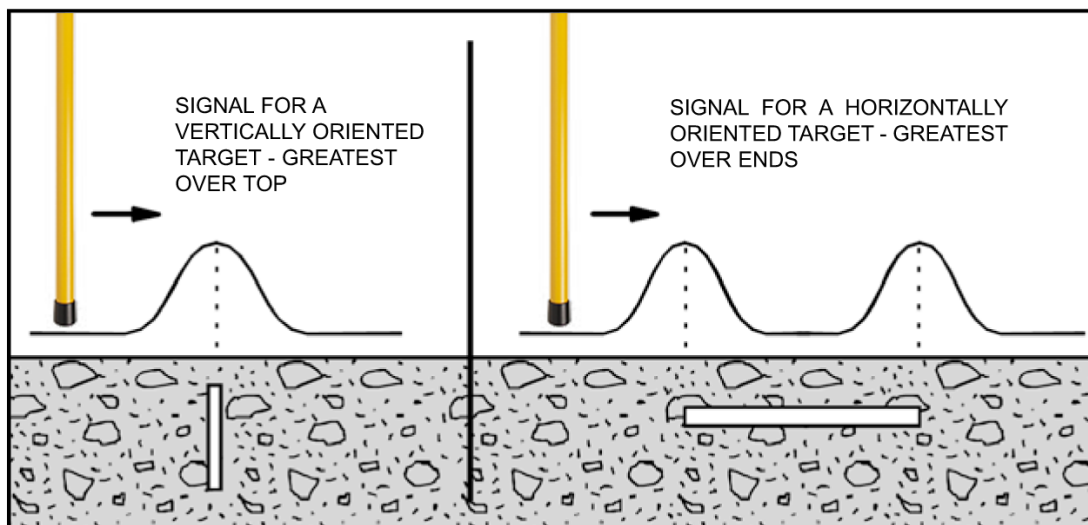

Figure 5: Signals from Vertical and Horizontal Targets

After you have detected the presence of a target, hold the locator vertically, slowly move it back and forth in an "X" pattern and listen to the audio response. The audio peak will occur when the locator is directly over a vertical target, or it will occur over the ends of a horizontal target. The "X" pattern, as shown in Figure 6, is ideal for pinpointing small objects. By using this technique, a 1-1/4 inch PK nail buried up to 12 inches can be precisely located.

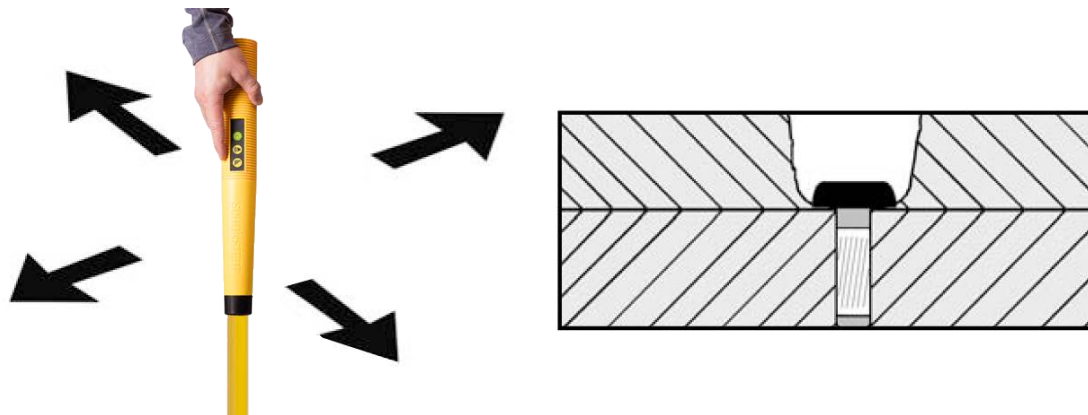

Figure 6: The "X" pattern provides precision locating

If you are looking for a corner marker and detect two or three signals in the same general vicinity, raise the locator several inches above the ground or decrease the gain setting. Any signal that disappears (either when the locator is held higher or when the gain is decreased) is likely coming from a smaller target. The signal from a rusty bolt or other small item (see Figure 7) is much weaker than the signal from a larger target, such as an 18-inch length of 3/4 inch rebar which can be located at depths up to 9 feet.

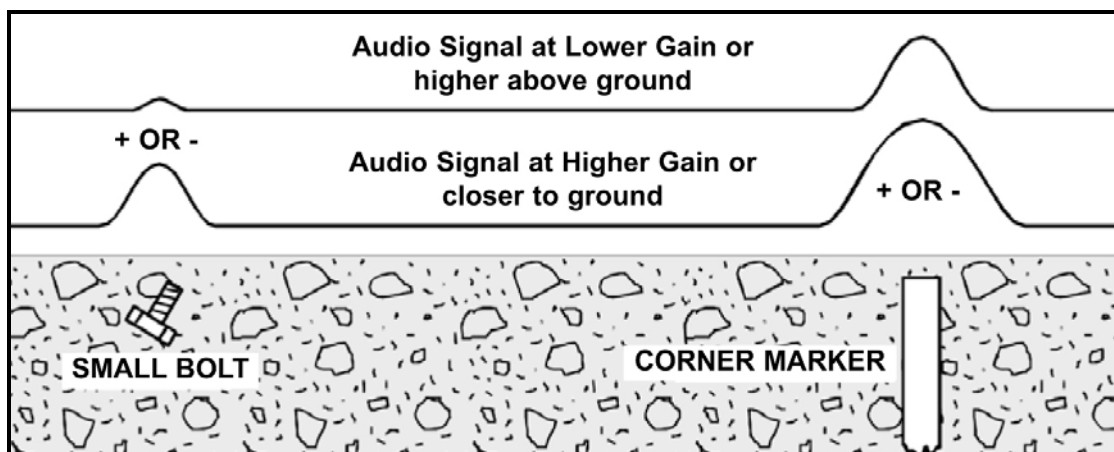
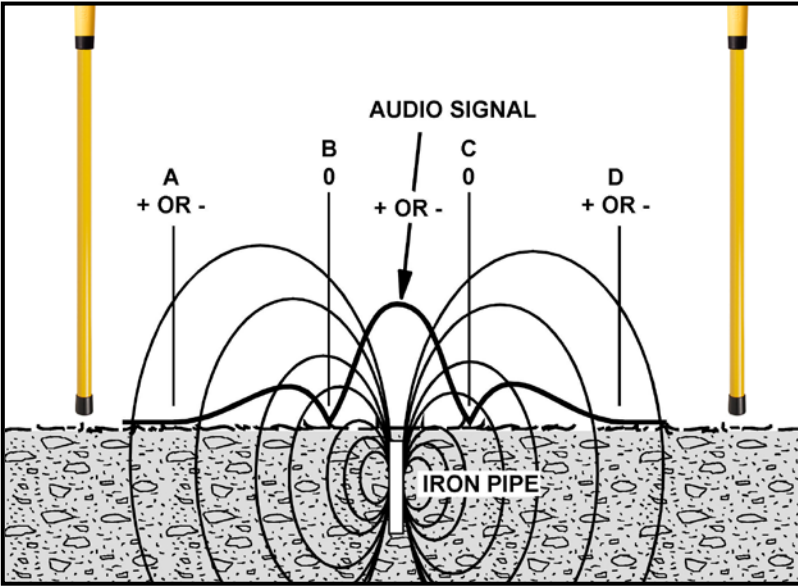

Figure 7: Decreasing the gain or lifting the locator eliminates unwanted signals

## Strongly Magnetized Markers

A strongly magnetized marker, at or near the surface, provides a weaker indication on both sides of the marker that could be mistaken for the marker.

In Figure 8, the heavy line represents the increase and decrease in the audio signal frequency as you move the locator over a marker. Between points **A** and **B**, the signal increases slightly and then decreases. Just beyond **B**, the signal increases rapidly, peaks directly over the marker and then decreases at point **C**. From **C** to **D**, the signal increases and decreases again. Therefore, if you do not move the locator completely across the marker, you may assume that the weaker indication on either side of the marker is its location.



The two weaker indications occur because the locator is extremely sensitive to the magnetic field components parallel to its long axis. At points **B** and **C**, the field is perpendicular to the locator, so no significant audio indication is produced at these points.

Figure 8: Signal Pattern from a Strongly Magnetized Marker

## Correct Stake Orientation

When placing stakes, correct orientation is important. For verification purposes, the orientation of the pin relative to the locator is shown in Figure 9. Check the pin with one orientation, and then rotate the pin 180°. The orientation which gives the largest reading is the one that should be used.

An iron pin has two types of magnetization. One is the magnetization induced by the Earth's magnetic field; the induced magnetization is always downward in the Northern Magnetic Hemisphere. The other type of field is the permanent magnetization, which is fixed to the pin. For maximum detection, the stake should be driven into the ground so that the permanent magnetization is in the same direction as the induced magnetization.

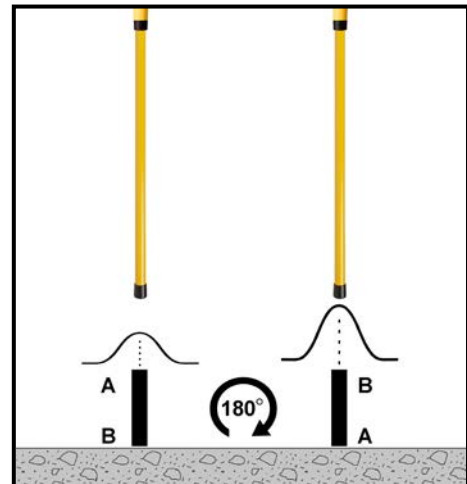

Figure 9: Checking a Stake's Orientation

## Locating Manholes, Septic Tanks and Well Casing

The magnetic field is strongest at the edge of a shallow manhole cover. You can easily trace the edges of covers near the surface. The locating depth for manhole covers ranges up to 10 feet.

The great length of a well casing provides a strong field at the surface that makes it easy to locate casings buried up to 18 feet deep.

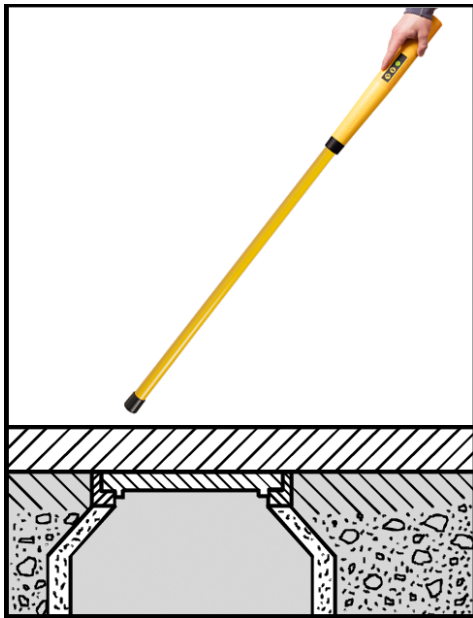

Figure 10: Locating Manhole Covers

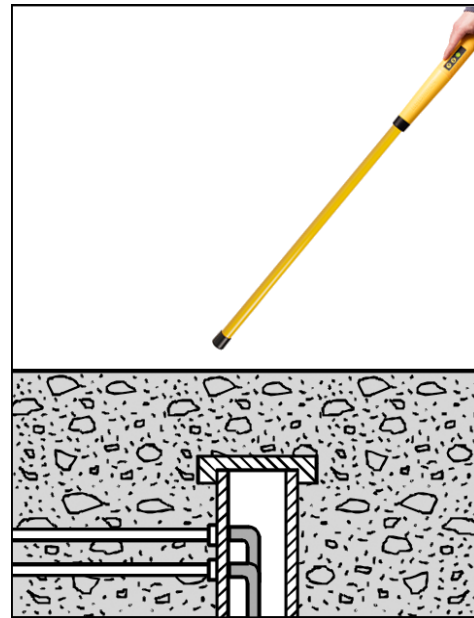

Figure 11: Locating Water Well Casings

SPOT can be used to precisely locate the metal handles or reinforcing bars on septic tank covers at depths of up to 5 feet.

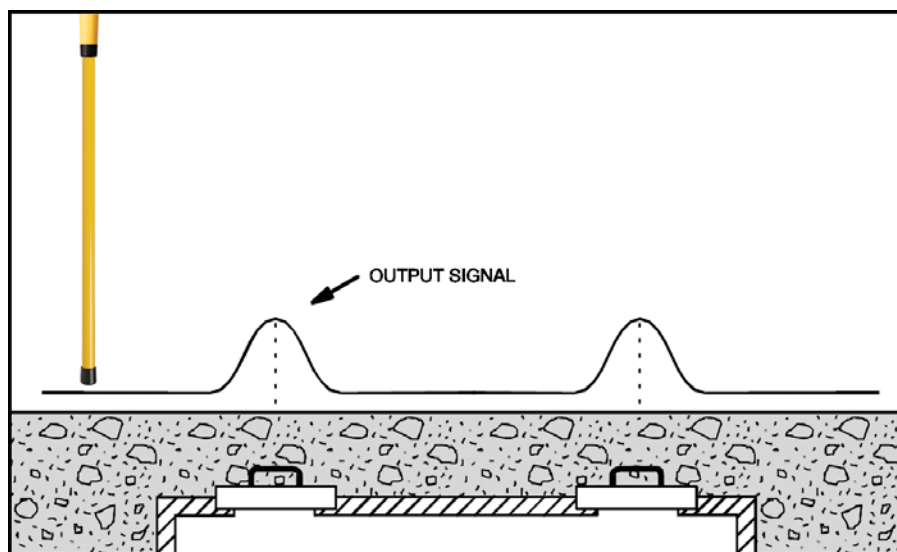

Figure 12: Signal Pattern Provided by Septic Tank Covers

## Locating and Tracing Barbed Wire

You can often trace barbed wire (from old fence lines) buried just beneath the surface. Even if the wire is only a trail of rust, it can still be detected near the surface. Tip the locator a little lower than usual (but not parallel with the ground).

First, examine trees for bench marks and bits of embedded barbed wire. Then, hold the locator parallel with the direction of the wire.

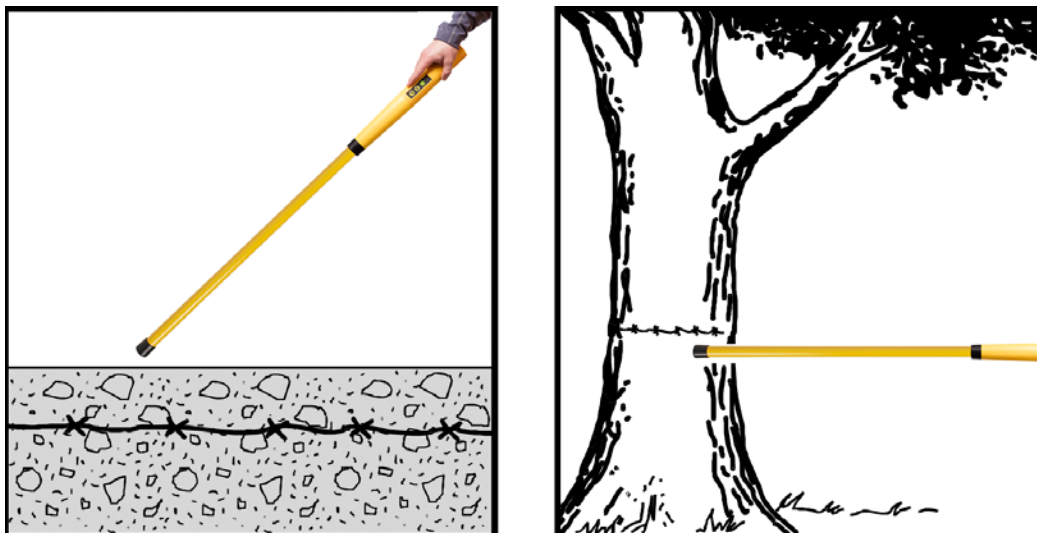

Figure 13: Tracing Barbed Wire from Old Fence Lines

## Searching Areas along a Chain Link Fence

Searching in the vicinity of a chain link fence requires a reduced sensitivity setting and some control over the orientation of the locator. As illustrated in Figure 14, position the locator horizontally with its long axis perpendicular to the fence. This ensures that the upper sensor is kept away from the fence.



Figure 14: Searching in the Vicinity of a Chain Link Fence

Along the fence, perform the search by slowly moving the locator forward while also moving it to the right and to the left. As you move forward, this technique will allow you to search an area that is several feet wide. Listen for an abrupt drop in the signal (as shown by the null in Figure 15) that will occur when the lower sensor, located 1-5/8 inches from the end of the locator, is directly over the stake. Any variation in the position of the locator will produce an abrupt rise in the frequency of the signal.

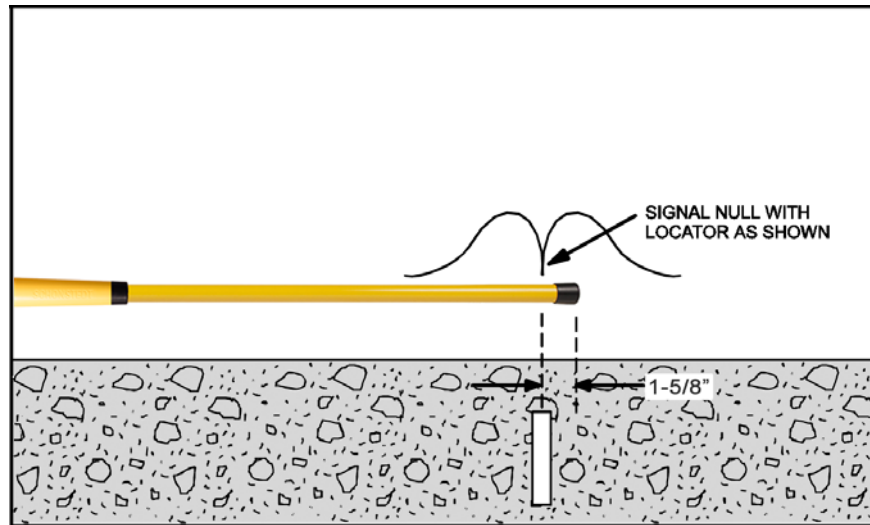

Figure 15: Placement of Locator While Searching Along a Chain Link Fence

## Locating Valve Boxes

Both the valve and its casing, when iron, provide strong magnetic fields that make them easy to locate. Plastic enclosures containing magnets (which are typically used with non-ferrous valve boxes) are easily located at depths of up to 10 feet.

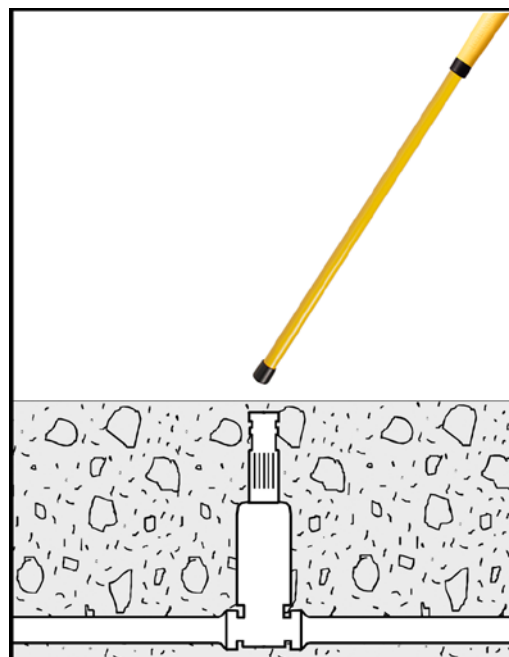
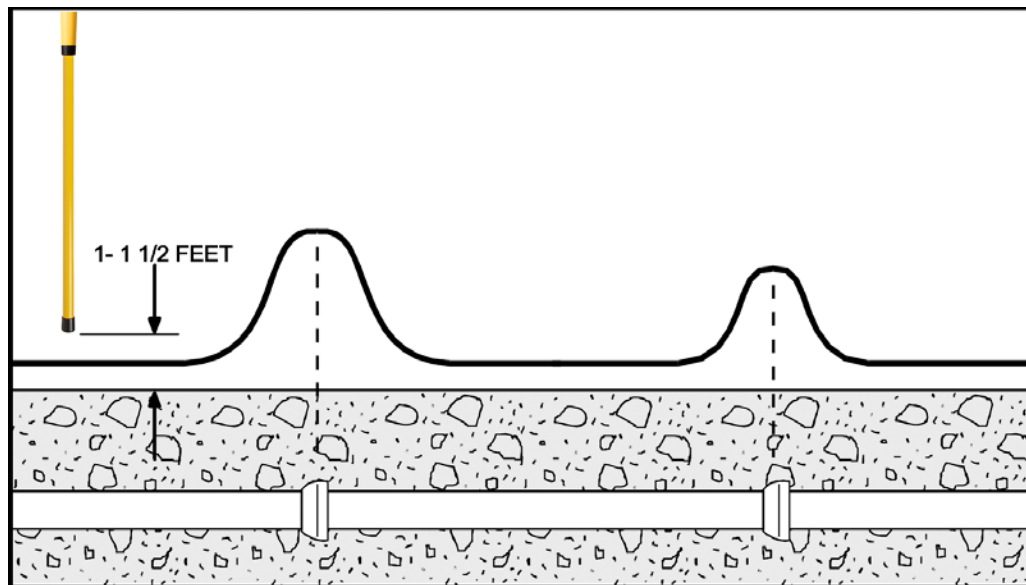

Figure 16: Locating Valve Boxes and Casings

## Locating Cast-Iron Pipes

Cast-iron pipes produce the strongest magnetic signals at their joints.



*Figure 17: Signal Patterns Provided by Cast-Iron Pipes*

After an initial sweep search identifies the general direction of the pipe, the steel pipe joints or transition points can be more accurately traced by the following procedure:

1. Set the sensitivity control to maximum (#5).
2. Hold the locator vertically approximately 1 to 1-1/2 feet above the surface.
3. Walk without turning or tilting the locator.
4. Mark the locations where the maximum signal levels occur.
5. Return to an area of maximum signal strength and hold the locator several inches above the surface. The sensitivity will probably have to be reduced during this second pass. Four-inch pipes can be located at depths of up to 10 feet.



## Locating Steel Drums

As shown in Figure 18, the signal pattern will vary depending on the vertical or horizontal orientation of the drum and how deep it is buried. A 55 gallon drum can be located at depths of up to 10 feet.

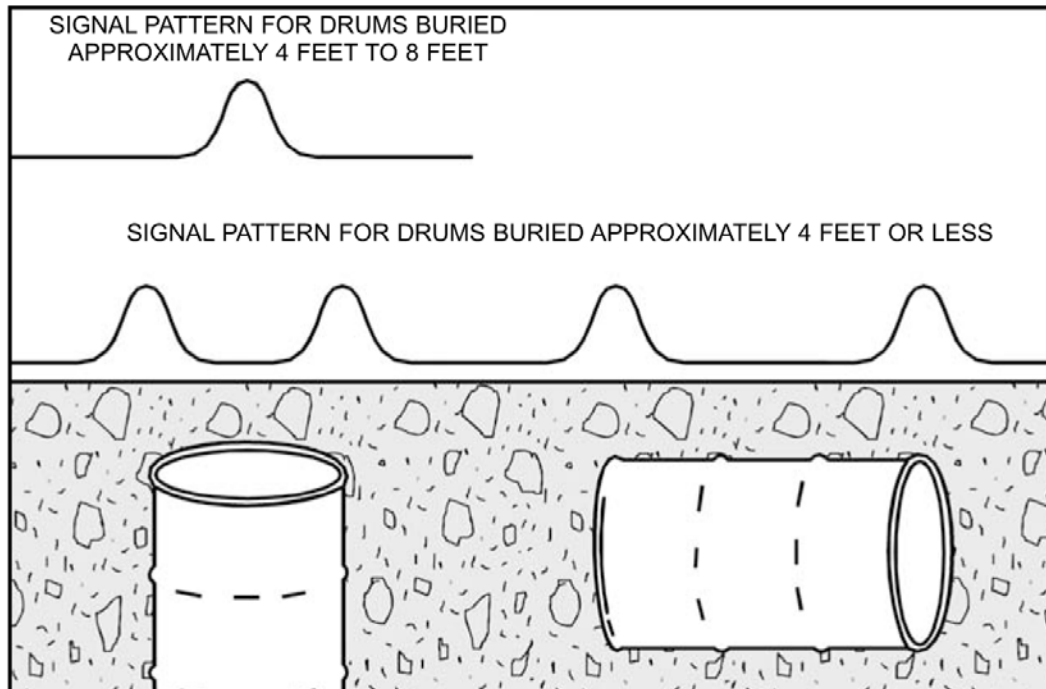

Figure 18: Signal Patterns Provided by Steel Drums

## Additional Notes

1. SPOT can detect buried ordnance and discarded weapons. SPOT is a viable tool for use by the military and local/state police departments.
2. People drilling in an area where hazardous materials might be encountered can use SPOT to search the area prior to drilling.
3. A burbling sound indicates the presence of an energized power line or the presence of 50/60Hz.
4. The instrument will not respond to non-ferrous metals such as gold, silver, copper, brass and aluminum.

# 4

## SPECIFICATIONS AND REGULATORY COMPLIANCE



## Specifications \*

<b>Audio Output</b>	Frequency increases or decreases with signal strength (gradient field intensity). Range: 30 to 4000 Hz.
<b>Low Battery</b>	0.5 sec Audio beep, every 13 seconds, when lower than 6.8V
<b>Gain</b>	5 levels: Extra Low (1), Low (2), Medium (3), High (4), Extra High (5) Audio: Progression of audio beeps to correlate with gain setting (one beep for #1, two beeps for # 2, and so on)
<b>Volume</b>	2 Levels: Medium and Maximum (default upon turn on)
<b>Input Power</b>	Supplied by one 9V battery
<b>Battery Life</b>	24 Hours (intermittent usage)
<b>Operating Temperature</b>	-13°F to 140°F (-25°C to 60°C)
<b>Overall Length</b>	42.3" (107.4 cm)
<b>Nominal Sensor Spacing</b>	20" (50 cm)
<b>Weight</b>	Approximately 2.0 lb. (0.9 kg)
<b>Construction Material</b>	High impact ABS body, Aluminum tube for sensors
<b>Water and Dust Protection</b>	Rated IP54 overall, waterproof up to 27" (58 cm) from bottom tip

*\*Subject to change without notice*

## Regulatory Compliance and Declaration of Conformity

### FCC:

++++

FCC Part 15B, Class B

This device complies with Part 15 of the FCC Rules. Operation is subject to the following two conditions: (1) this device may not cause harmful interference, and (2) this device must accept any interference received, including interference that may cause undesired operation.

### Industry Canada:

+++++

CAN ICES-003 (B)/NMB-003(B)



### CE Mark:

+++++

Application of Council Directives:

Directive 2014/30/EU (EMC)

Standard to which conformity is declared:

EN 61326-1:2013

Directive 2011/65/EU (RoHS2)

Standard to which conformity is declared:

EN 50581:2012

### International Protection Marking (IEC 60529):

+++++

Rated IP54 for dust particles larger than 1 mm, and splashing water per test (a) (10 minutes, oscillating fixture) and test (b) (5 minutes with shield in place).

# 5

## TECHNICAL SUPPORT/SERVICE INFORMATION



Schonstedt offers technical support and sales support. For any reason, regarding usage and application, please contact our technical support team at 888-367-7014.

**FOR SERVICE OR REPAIR**

Please ship unit to:

Schonstedt Instrument Company  
100 Edmond Road  
Kearneysville, WV 25430  
Attn: Customer Service Dept.

Return instructions and the Return Form are located online at:  
<https://www.schonstedt.com/support/repair-department/>

# 6

## WARRANTY



Schonstedt Instrument Company (Schonstedt) warrants each product of its manufacture to be free from defects in material and workmanship subject to the following terms and conditions. The warranty is effective for 7-years\* after the shipment by Schonstedt to the original purchaser. Please complete the warranty registration card online at [schonstedt.com/welcome](http://schonstedt.com/welcome).

Schonstedt's obligation under the warranty is limited to servicing or adjusting any product returned to the factory for this purpose and to replacing any defective part thereof. Such product must be returned by the original purchaser, transportation charges prepaid, with a description of the defect in writing. If the fault has been caused by misuse or abnormal conditions of operation, repairs will be billed. Specifically, this warranty does not cover product that has been subject to inundation by fire, water or other liquid intrusion, or units that have been damaged or compromised due to repair, alteration or modification by anyone other than an authorized repair representative. Prior to a repair being performed by Schonstedt, a cost estimate will be submitted and no work will be completed until authorized by the customer. Batteries are specifically excluded under the warranty and should be addressed to the manufacturer of batteries in question.

Schonstedt shall not be liable for any injury to persons or property or for any other special or consequential damages sustained or expenses incurred by reason of the use of any Schonstedt product.

\* For Military & EOD applications, the warranty is 1 year.

Manufactured By  
Schonstedt Instrument Company  
100 Edmond Road, Kearneysville, WV 25430  
Phone: (800) 999-8280 Fax (304) 725-1095